

No.
130



A WORLD LEADER IN
CORE DIAGNOSTIC
INSTRUMENTS



Extraordinary Tools for Exceptional Care

In the early 1980s, ADC founders Marc Blitstein and Neal Weingart shared a vision of a medical device company built on global manufacturing partnerships and vibrant domestic production. It would be a business defined by quality, made possible by great people and steadfast relationships. In the decades since, ADC's product line, customer base, and approach to manufacturing and distribution have evolved greatly. Today, we're an industry leader known for the diverse, deep, and dependable

product line that's showcased in this catalog.



MANUFACTURING

ADC products enjoy a reputation for advanced design combined with skilled craftsmanship. We were an

early pioneer of a global production model, sourcing components and finished goods from the world's leading ISO 13485 manufacturers – many on an exclusive basis. These single-sourced, long-term relationships ensure consistency, lot after lot, year after year. More recently, we opened our own manufacturing subsidiary in Suzhou, China, employing 80 staff.

Most of ADC's core diagnostic products are fully assembled, inspected, and packaged in our New York facility.



This blend of global sourcing and domestic production allows ADC products to be priced considerably lower while maintaining the highest standards for quality.

INDUSTRY-LEADING WARRANTIES

Our commitment to manufacturing excellence is evident in our product warranties, which are among the most comprehensive in the industry. Several of our stethoscopes and manometers come with lifetime warranties.

INSPECTION, TESTING, QUALITY CONTROL

We take quality seriously and engineer it into every stage of our product life cycle. Few in the industry can match the investments we've made in this arena. Quality and



sourcing offices in Ningbo, China, and Taipei, Taiwan, sample each shipment from every vendor to ensure our products meet – and often beat – the toughest national and international standards. Components are inspected

again in our New York testing lab, using custom-built test machines and equipment, as are the finished instruments we assemble domestically. More about our processes is described in the product sections.



But don't just take our word for it. Compare the performance, features, and durability of any ADC product to any other on the market. Then compare the price. You'll soon discover there's simply no comparison at all!



Scan here to view our products online at adctoday.com



@AMERICANDIAGNOSTIC



55 Commerce Drive
Hauppauge, NY 11788
tel: 1-800-232-2670 • fax: 631-273-9659

www.adctoday.com

Contents

Vital Signs Monitors **4**

Adview™ 2	5
e-sphyg™ 3	6
Feature Chart	7

Pulse Oximetry **8**

Fingertip Pulse Oximeters	9-10
Feature Chart	8

Sphygmomanometers **11**

Bariatric	22-23
Clock Aneroids	34-35
Combination Kits	24-29
Digital Home Monitors	36-39
e-sphyg™	14-15
Feature Charts	36
Home Kits	40
Mobile Aneroid	35
Multicuff Systems	30-33
Palm Aneroid	17
Pocket Aneroids	18-21
Wall Aneroid	35

Blood Pressure Parts **44**

Adcuff+	46-47
Bulbs and Valves	45
Carry Cases	126
Coiled Tubing	49
Connectors	48
Cuffs	42-43, 46-47
Cuff and Bladders	46, 47
Gauges	45, 47, 50
Inflation Systems	47
Size Charts	43
SPU Cuffs	42-43

Stethoscopes **51**

Adimals®	69
Adscopes®	51-733
Bowles	77
Cardiology	54-58
Cases	82
Clinician	59-64
Comparison Charts	54, 59, 65
Convertible	61, 62, 70-73
Disposable	76-77
Hip Clips and Holsters	83
ID Tags	84
Infant	68, 75-76
Nurse	74-76
Pediatric	65-69, 75-76
Proscopes™	73, 74-77
Spragues	70-73
Teaching	78-80

Infrared Thermometry **85**

Feature Chart	85
Non-Contact	86-88
Tympanic	89

Digital Thermometry **85**

Digital	85-94
Feature Chart	85, 90
Hypothermia	93
Patient Kits	94
Mini	87
Sheaths	94
Stick	90-94
Temple Touch™	91
Veterinary	94

Diagnostics **95**

Adstation™	100, 109-112
Dermascope	100
Diagnostic Sets	103-108
Feature Charts	103-113, 112
Ophthalmoscopes	99
Otoscopes	98
Pocket Sets	105
Power Supply	100-102
Throat Illuminator	100

Laryngoscopes **113**

Feature Chart	117
Fiberoptic	115
Sets	116
Standard	

CPR **117**

Airways	118
Bite Stick	118
Face Shields	119
Resuscitator Mask	120

Protective Eyewear **121**

Caseware **123**

Medical Bags	124-125
Nurse Organizers	126
Nylon Holsters	127
Trauma Bag	125

Neurological Instruments **129**

Neuro Hammers	131-132
Tuning Forks	130

Diagnostic Penlights **133**

Disposable	136
LED	134, 135
Reusable	134, 135

Instruments & Accessories **137**

EKG Caliper	141
Folding Knives	140
Forceps	139
Goniometer	141
Ring Cutter	140
Scissors	139
Shears	138
Tape Measure	139

Product Index **141**

Color Chart	147
Icon Legend	147
Index	137-145

Vital Signs Monitors



The Importance of Average Mode

The evidence is clear: You get more reliable blood pressure results with a series of sequential readings that are averaged into a single result. That's why both the Adviev 2 and the e-sphyg 3 feature user-definable average mode technology.

ADC's lineup includes two clinical-grade monitors for automated NIBP or vital signs: the Adviev 2 Modular Diagnostic Station and the e-sphyg 3 Digital Blood Pressure Monitor. Both offer incredible feature sets with budget friendly pricing, along with a purchase and support experience that's second to none. Each features a customizable average mode and a manual mode for validating automated blood pressure readings or to help when measuring patients with arrhythmias or other complex needs. Desk, wall, and mobile platforms provide flexible solutions for every type of practice.

Platforms for Every Practice Workflow

Both the Adviev 2 and the e-sphyg 3 provide modern, compact designs that are self-standing for desktop or tabletop use, with built-in handles. Well-built, ergonomic desk, wall, and mobile options are also available to match day-to-day workflow.



Diagnostix Adstations,
see page 109

Also available for the e-sphyg 3:



Build a mini vitals station
with our Premium Desk Caddy



Padded Carrying Case

**Modular, Multiplatform,
Affordable – Evolved**



*Some assembly required



Our truly modular design allows you to create the diagnostic station that's perfectly suited to your needs. Start with the fully featured Blood Pressure base unit and add optional Temperature and SpO2 functionality, now or in the future. Order modules at the time of purchase and we'll ship your Adview 2 configured, or add them as you need them to upgrade in the field.

Adview® 2 Modular Diagnostic Station

The world's first — and still only — truly modular diagnostic station. Now in its second generation.

The Adview® 2 features

- A flexible design with up to three modules: blood pressure, temperature, and pulse oximetry
- Clinical-grade Advantage™ BP technology from SunTech Medical®
- A proprietary manual BP mode, allowing measurement with a stethoscope using the auscultatory method
- New, customizable average mode, with setting options ranging from two to five readings and start and interval delays
- A temperature module featuring Covidien Filac™ technology, providing accurate measurement in about 10 seconds. Module comes with standard oral/axillary probe; optional rectal probe available.
- ChipOx Nellcor™ SpO2 module, providing accurate readings in about 10 seconds. Optional pediatric sensor available.
- Contemporary, compact design with an easy-to-read LCD display and an integrated handle for portability
- Lithium ion power for longer battery life and lighter weight
- Desktop, mobile, and wall mount options
- Optional accessories, including a Wi-Fi dongle and two scanner options (linear or 2D) for uploading patient data to your facility's EMR
- Network-enabled technology with IHE HL7 messaging
- Three-year warranty on the blood pressure base unit, SpO2 module, and temperature module; three-year warranty on cuffs; 90-day warranty on all other accessories

Ordering Information

Unit Models		Mounting Accessories and Platforms	
BP Only	9005BP	Desk Caddy*	9005D
BP/Temp	9005BPT0	Wall Mount	9005W
BP/SpO2	9005BPS	Mobile Stand	9006M
BP/Temp/SpO2	9005BPST0	*Optional desktop caddy keeps cuffs and cords organized.	
Accessories	Barcode Scanner	WiFi Dongle	
	Item No.	9005SCANL	9005DON
		9005SCAN2D	

Customers ordering in Canada can call 1-800-ADC-2670 for model availability.



Included Adcuff+ Sizes:



Optional Adcuff+ Sizes:



Visit our website for all available accessories



ADCUFF+
option
NOW
available



e-sphyg 3™ Digital Blood Pressure Monitor

Our all-new, clinical-grade digital blood pressure monitor is the economical, easy-to-use solution you've been waiting for.

The e-sphyg 3 features

- Auto mode for quick readings in as little as 30 seconds
- Manual mode for auscultation with a stethoscope
- Customizable three-reading average mode with individual measurement display
- Last-reading memory
- Irregular heartbeat detection
- Oscillometric measurement with systolic and diastolic blood pressures, pulse rate, and mean arterial pressure (MAP)
- High-capacity rechargeable battery, standard
- For use with adult and pediatric patients
- Validated for pregnancy and preeclampsia
- Includes Small Adult, Adult, and Large Adult Ad cuffs with exclusive Size Guide Marking System to ensure accurate readings on virtually any patient
- Desktop design is self-standing and features built-in handle; or choose optional desk, wall, or mobile platforms for added versatility in any practice
- Three-year warranty on unit, cuffs, and platforms; one-year warranty on battery and accessories

Ordering Information

Unit Models

e-sphyg 3 with Sm Adult, Adult, Lrg Adult Cuffs	9003K-MCC
e-sphyg 3 with Sm Adult, Adult, Lrg Adult Ad cuff+	9003K-MCC1

See page 46 for information on our new one-piece Ad cuff+ line.

Mounting and Platforms

e-sphyg 3 Desk Caddy	9003D
e-sphyg 3 Desk Caddy for 2200 and 429	9003TS1
e-sphyg 3 Desk Caddy for 2200 and 433	9003TS2
e-sphyg 3 Mobile Stand and Basket	9003M
e-sphyg 3 Wall Mount and Basket	9003W
e-sphyg 3 Padded Carrying Case	9003BAG

Customers ordering in Canada can call 1-800-ADC-2670 for model availability.

Included Cuff Sizes:

Small Adult	Adult	Lg. Adult
-------------	-------	-----------



Features & Comparison

Feature	CLOCK ANEROID	e-sphyg 3	Advview 2
Accuracy ¹	+/- 3mmHg or less	+/-3mmHg or less	+/- 5mmHg mean error with 8mmHg standard deviation
Accuracy Maintenance	Must periodically test against a reference standard	Self test lets operator know if calibration is needed ²	Self test lets operator know if calibration is needed ²
Display	Analog	LCD	LCD
Inflation	Manual	Automatic	Automatic
Deflation	Manual	Automatic	Automatic
Measurement Method	Auscultatory (Manual with scope)	Oscillometric (in Auto Mode) Auscultatory (in Manual Mode)	Oscillometric (in Auto Mode) Auscultatory (in Manual Mode)
Heart Rate	No	Yes	Yes
MAP	No	Yes	Yes ³
BP Averaging	N/A	Yes	Yes
Automatic Inflation	N/A	Yes (To Automatic or Preset Levels)	Yes
Manual Blood Pressure Mode	Yes	Yes	Yes
One-Button Inflation	No	Yes (To Preset Levels)	Yes (Fully Automatic)
Automatic Deflation	No	Yes	Yes (3-4 mmHg/sec)
Cuff Sizes Compatible with Auto Mode	N/A	(3) Sm. Adult, Adult, Lg. Adult	(5) Child, Sm. Adult, Adult, Lg. Adult, Thigh
Cuff Sizes Compatible with Manual Mode	7	3	5
Cuffs Included	Adult	3 Sm. Adult, Adult, Lg. Adult Traditional or Adcuff+	2 Adult, Lg. Adult Adcuff+
Power Supply	Manual	NiMH Battery/ AC Power	Li-ion/ AC Power
Readings on Single Charge	N/A	800-1200	200
Platforms			
Bag	No	Yes	No
Desk	Yes	Yes (2 styles)	Yes
Wall	Yes	Yes	Yes
Mobile	Yes	Yes	Yes
Memory	No	Last Reading	99 Reading
Upgradeability (Measures other parameters)	No	No	Yes Optional Temp & SpO2 Modules
Printer or PDF Interface	N/A	No	Yes
EMR Interface	No	No	EMR Capable
Calibration Warranty	Generally Lifetime	3 Year	3 Year

¹ Accuracy of pressure sensor

² Periodic check against a reference standard is recommended

³ Not validated for MAP in USA

Fingertip Pulse Oximetry



Carry lanyards and batteries included with all models.

ADC's line of fingertip pulse oximeters spans a range of price points with solutions for both adult and pediatric patients. All styles combine the finger sensor probe, electronics, and display screen in a compact, well-designed housing, providing spot SpO2 and heart rate readings in just a few seconds.

The fully featured 2100 and 2150 are designed for professional use. Both models offer a two-color OLED display, six display orientations, multiple brightness settings, graphical display of pulse wave form, and rubberized protective bumper sleeve. The value-priced 2200 features a one-color LED display, pulse strength indicator, and two display orientations.

2100 Diagnostix™



Page 9

2150 Adimals®



Page 10

2200 Advantage®



Page 10

Model/Brand	2100 Diagnostix™	2150 Adimals®	2200 Advantage®
Patient Size	Adult	Pediatric	Adult
Fingertip Range	8-20mm	7.64-11.19mm	8-20mm
SpO2 Display Range	0-100%	0-100%	0-100%
Pulse Display Range	0-254 BPM	0-250 BPM	0-250 BPM
Pulse Strength Indicator	Plethysmograph	Plethysmograph	Plethysmograph
Oxygen Saturation Accuracy	+/- 3%	+/- 2%	+/- 2%
Pulse Rate Accuracy	+/- 2 BPM	+/- 2 BPM	+/- 2 BPM
Display Technology	OLED 2 color	OLED 2 color	Red LED
Audible Indicators	Yes	No	No
Display Configurations	6	6	2
Display Brightness Adjustments	Yes	Yes	No
Hinged Battery Cover	Yes	No	No
Power Source	2 AAA	2 AAA	2 AAA
Battery Life	20-30 hrs	20-30 hrs	20-30 hrs
Carry Lanyard	Yes	Yes	Yes
Bumper	Yes	Yes	No
Storage Case	No	Soft Nylon	No
Dimensions	58x32x34mm	50x28x28mm	55x29x25mm
Weight (without batteries)	31 g	19 g	31 g
Warranty	2 Year	2 Year	1 Year

Diagnostix™ 2100 Digital Fingertip Pulse Oximeter

A portable, feature-rich pulse oximeter that provides spot readings of SpO₂ and heart rate for the busy healthcare professional.

The 2100 features

- SpO₂ and pulse rate readings
- Accuracy: SpO₂ ±3% / HR ±2 BPM
- Six changeable display modes
- 10 display brightness settings
- Visual and audible indicators
- 25% smaller than competing models
- Fits fingers with a thickness of .31" to .79" (8mm to 20mm)
- Dual-color OLED display
- Secure, hinged battery cover
- Carry lanyard and black or orange rubberized bumper included
- Two AAA batteries
- Instruction booklet
- Two-year limited warranty



2100



2100OR

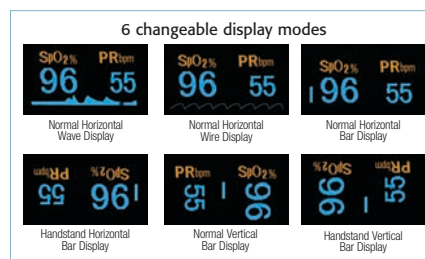

Ordering Information

Item	Description
2100	Diagnostix™ Fingertip Pulse Oximeter, Black
2100OR	Diagnostix™ Fingertip Pulse Oximeter, Orange
2100CN	Diagnostix™ Fingertip Pulse Oximeter (Canada)
2100-1	Pulse Oximeter Carry Lanyard
2100-2BK	Pulse Oximeter Safety Bumper, Black
2100-2OR	Pulse Oximeter Safety Bumper, Orange

Customers purchasing in Canada, can choose the 2100CN.





Carry Case and Lanyard

2150 Digital Fingertip Pulse Oximeter

Our pediatric fingertip pulse oximeter with a kid-friendly face!

The 2150 features

- SpO₂ and pulse rate readings
- Accuracy: SpO₂ ±2% / HR ±2 BPM
- Six changeable display modes
- Dual-color OLED display
- 10 display brightness settings
- Child-friendly instrument face
- Fits fingers with a thickness of 0.3" to 0.44" (7.64mm to 11.19mm)
- Carry lanyard
- Soft carry case
- Two AAA batteries
- Instruction booklet
- Two-year limited warranty



Ordering Information

Item	Description
2150	Adimal™ Fingertip Pulse Oximeter
2100-1	Pulse Oximeter Carry Lanyard

 The 2150 is not available for sale in Canada



Advantage™ 2200 Digital Fingertip Pulse Oximeter

A portable fingertip pulse oximeter.

The 2200 features

- SpO₂ and pulse rate readings
- Accuracy: SpO₂ ±2% / HR ±2 BPM
- Two changeable display modes
- Bright red LED display
- Fits fingers with a thickness of .31" to .79" (8mm to 20mm)
- Carry lanyard
- Two AAA batteries
- Instruction booklet
- One-year limited warranty

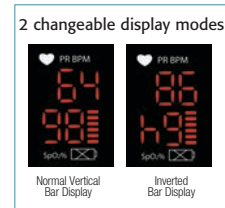

Carry Lanyard

Ordering Information

Item	Description
2200	Advantage™ Fingertip Pulse Oximeter
2100-1	Pulse Oximeter Carry Lanyard

 The 2200 is not available for sale in Canada



Aneroid Sphygmomanometers

Mechanical blood pressure is ADC's biggest product category. We are the largest privately held manufacturer of sphygs by unit volume in the United States – larger than the next three competitors combined – and the largest private label supplier.

Our **Diagnostix** and **Prosplyg** brand components, and private label versions, are made exclusively for ADC by the world's best contract manufacturers. **Sphygs are then inspected, assembled, and packaged in New York.** We subject every single gauge to 100% visual inspection for zero point and test up to 15% for accuracy. A random sample from every batch is subjected to a destructive endurance test, putting them through 30,000 inflation cycles: three times the requirements under ANSI/AAMI/ISO 81060-1.



At the heart of every ADC aneroid is a **movement assembled under optimum conditions** to ensure it is free of the contamination found in lesser-built competitive instruments. The precision-crafted movement is heat treated and pre-aged to eliminate hysteresis, the stretching that often plagues cheaper products and knocks them out of calibration early in their life. The basic movement is optimized for each of the various models we produce.

DOMESTIC ASSEMBLY and INSPECTION

We assemble every manual sphyg (unless otherwise noted) in our New York facility. Our assemblers are thoroughly trained and empowered to reject non-conforming parts during the manufacturing process. Final Quality Control with lot coding ensures the instrument you receive will work perfectly.

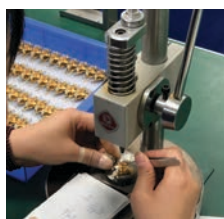

ADC is classified by the FDA as a true manufacturer, holding many of our own 510(k) premarket approvals

We produce three types of aneroid instruments: pocket, one-handed palm, and clock. With 35 models and hundreds of model options, there's a solution for every price point, budget, or clinical need.

POCKET GAUGES

Pocket gauges are our most popular design. Die-cast zinc housings are heat treated, to minimize the impact of ambient temperature variations, then meticulously finished in a baked enamel or a chrome plate. **Movements are carefully mounted and tested repeatedly.** Scale plates are serialized with a code that allows us to identify the production lot. From our basic 809 series manometer to our top-of-the-line 800-series, each model provides a unique feature set that differentiates it from competing models.



Our feature-rich 800-series manometer, used in our premium 700-series pocket aneroid, boasts a chrome-plated housing polished to a sterling shine, an extended scale plate to eliminate parallax error, a luminescent dial, and a lifetime calibration warranty.

PALM GAUGE

Our palm gauge incorporates the gauge, bulb, and valve into a single assembly, making it more convenient to use, particularly in multicuff solutions. To help isolate its premium movement from the vibration that often disables lesser-built instruments, the 804N's **movement is housed in a zinc cage** suspended within an impact-resistant ABS polymer shell that acts as a shock absorber. And while most palm-style manometers utilize a traditional thumbscrew valve that is often difficult to control, our 804N manometer features a **two-position trigger air-release valve**, with infinite control in deflation mode and rapid exhaust when locked in the open position. And because it's centrally positioned behind the manometer (rather than to one side), it allows for ambidextrous use.



CLOCK ANEROID

ADC's clock aneroid is available in wall, desk and mobile platforms. The clock aneroid features a **more robust spring** to handle the heavier weight of the indicator needle and a **special internal air restrictor** to reduce "needle bounce" that causes lesser-built clock models to lose calibration prematurely. The specially designed lens cover mounting system prevents dust from entering the manometer and contaminating the movement. Luminescent beveled dial is easy to read in virtually all light conditions.



The Adcuff Inflation System

210 DENIER NYLON

With nylon thread, sewn with 11 threads per inch. It's durable, comfortable, and easy to clean.

SIZE ICONS

Part of the Adcuff's proprietary Size Guide™ marking system. Allows for rapid size identification.

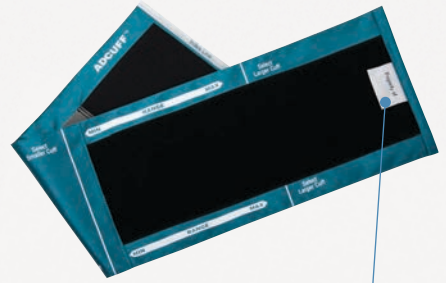

"PROPERTY OF" ID TAG

ID tag helps protect your investment. Includes four-digit lot code for quality assurance.

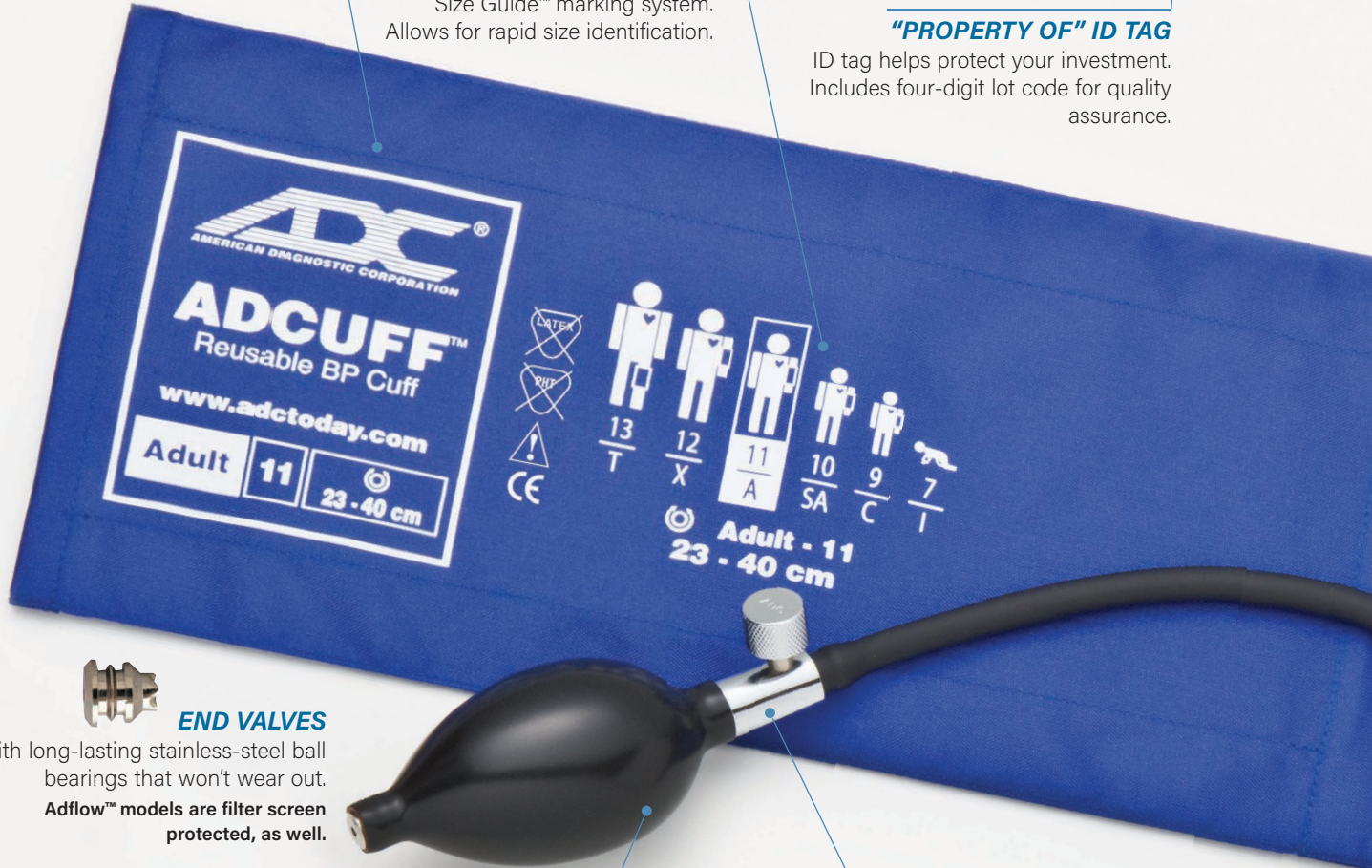

END VALVES

With long-lasting stainless-steel ball bearings that won't wear out. Adflow™ models are filter screen protected, as well.

INFLATION BULBS

In either neoprene (Diagnostix™ models) or PVC (Prosplyg™ models), made without natural rubber latex or phthalates.

STANDARD and FILTER SCREEN PROTECTED VALVES

Choice of standard or premium Adflow™ filter screen protected valves with proprietary micro-threading for precise deflation control. All valves are held to leakage standards 33% more stringent than ANSI standards require.

QUALITY CONTROL and TESTING

Adcuff components undergo multiple rounds of proprietary testing in our New York lab to ensure our products meet or exceed NIST standards. Tests include hook-and-loop adhesive durability, bladder leakage, and valve leakage.



Adflow™ Valve



Standard Valve

ADCUFF™ +

Our all-new line of one-piece reusable blood pressure cuffs designed for accuracy, comfort, and ease of use. Featuring a convertible design for use with single- or double-tube systems.



Look for this symbol for sphyg models that offer an Adcuff+ option

GAUGE HANG TAB

(Hidden from view)
Allows convenient use with any type of pocket aneroid.

HOOK-and-LOOP ADHESIVE

Rated to a minimum of 30,000 open/close cycles and repeatedly tested to 50,000.

INDEX and RANGE MARKINGS

Part of the Adcuff's proprietary Size Guide™ marking system, they facilitate the selection of the appropriate cuff and prevent miscuffing.



PROPRIETARY CONVERTIBLE BLADDER

Our Adcuff bladder design allows us to reduce the number of components by nearly 60%, ensuring virtually 100% fill rates no matter how big the demand.

Each is specially formulated and made without natural rubber latex or phthalates. Bladders are RF welded and tested to 50,000 cycles and 100% individually leak tested at the factory to ensure day-in and day-out dependability. Now made with TPU for a 98% improvement in weld strength.

BLADDER FLAP

Secures bladder, prevents bulging.

PROPERLY POSITIONED ARTERY MARK

(You'd be surprised how many aren't)
Printed on both inside and outside cuff surfaces to simplify cuff positioning.



e-sphyg Digital Aneroid



Manometer can be purchased separately or as a complete sphyg (see page 45 for gauge only)

Compatible with virtually any cuff on the market

ADC's e-sphyg™ is a revolutionary digital aneroid sphygmomanometer that replaces a gauge's vulnerable mechanical movement with virtually indestructible digital circuitry.

The instrument still uses traditional auscultatory measurement, the technique trusted by healthcare professionals for well over a century. But instead of pairing with an analog gauge or a potentially dangerous mercury-filled instrument, the practitioner's stethoscope is paired with a digital manometer featuring a bright, backlit LCD display and a splash- and shock-resistant housing that's virtually unbreakable. Stethoscope sold separately.



Our lifetime calibration warranty is so comprehensive that if the device ever needs service we will repair or replace it free of charge.





Stethoscope Required

e-sphyg™

The world's first digital aneroid sphygmomanometer.

The e-sphyg™ features

- Virtually indestructible design can withstand repeated drops of five feet or more
- Splash-resistant housing for use in harsh environments
- Swivel cuff clip allows the manometer to be repositioned for easy viewing
- Auto-off function conserves battery strength
- Dual low-battery warnings
- Recalibration reminder after 10,000 cycles (free lifetime recalibration)
- Systolic assist alerts practitioner to the onset of Korotkoff sounds – makes a great training aid
- Deflation-rate display promotes proper technique in accordance with AHA guidelines
- Pulse-rate display at completion of measurement
- Manometer works with virtually every cuff on the market
- Requires familiar and trusted manual auscultation (use of stethoscope) to obtain blood pressure readings
- Two AAA batteries (included)
- May be ordered as a complete sphygmomanometer featuring nylon Adcuff™ inflation system or gauge only for use with existing inflation systems (see page 43 for e-sphyg™ manometer)
- Lifetime calibration warranty

Ordering Information

Infant	Child	Sm. Adult	Adult	Lg. Adult	Thigh
7002-7IBK	7002-9CBK	7002-10SABK	7002-11ABK	7002-12XBK	7002-13TBK
7002-7IOR	7002-9CGR	7002-10SARB	7002-11AN	7002-12XBD	7002-13TBR

Additional Adult Cuff Color Options



NOTE: To ensure correct cuff color when ordering, add color suffix to model number (e.g., 7002-11AN)

Refer to page 45 for manometer only.



Aneroid Sphygmomanometers



Most sphygs are backed by a minimum 10-year calibration warranty and many models offer a lifetime warranty. All are made without natural rubber latex and phthalates.

Mechanical blood pressure is ADC's biggest product category. We are the largest privately held manufacturer of sphygs by unit volume in the United States – larger than the next three competitors combined – and the largest private label supplier.

Our top-of-the-line **Diagnostix** and value-priced **Prospbyg** brand aneroid components are made exclusively for ADC by the world's best contract manufacturers, then inspected, assembled, and packaged in New York. With seven models and more than one hundred configurations, there's a palm or pocket style solution for every price point, budget, or clinical need.

Gauge Styles

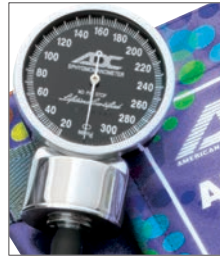

Pocket



Palm



Our **Bariatric Adcuff** has a unique, curved design that ensures a proper fit. Learn more on page 22.



Cuff Styles

- Two-piece reusable
- Bladderless, reusable Adcuff+
- Single-patient use disposable

For more cuff options, see pages 42 and 46.

Sizes and Colors

Available in up to seven clinical sizes and 17 color options. See page 41 for limb ranges.



ADCUFF+
option
NOW
available



Luminescent
Dial



Zinc Cage
Protects Movement



Ambidextrous
Trigger Valve

Diagnostix™ 703 Series

A versatile palm-style aneroid sphygmomanometer. Precision-crafted performance with rugged durability.

The 703 series features

- Revolutionary palm-style manometer (804N) with integral bulb and trigger-style air-release valve for one-hand convenience; exceeds ANSI/AAMI/ISO 81060-1 specifications for accuracy and is backed by a lifetime calibration warranty
- Precision-crafted 300mmHg Japanese-engineered movement tested to 30,000 cycles
- Movement housed in a zinc cage that suspends within the polymer housing for enhanced shock resistance
- Ambidextrous infinite-control trigger-release air valve
- Adcuff™ nylon cuff with ADC's proprietary Size Guide™ marking system prevents miscuffing
- Quick-release bayonet-style connector
- Complete with leatherette carry case with self-repairing nylon zipper
- Assembled, inspected, and packaged in the USA from foreign components

Ordering Information

Infant	Child	Sm. Adult	Adult	Lg. Adult	Thigh
703-7IBK	703-9CBK	703-10SABK	703-11ABK	703-12XBK	703-13TBK
703-7IOR+	703-9CGR+	703-10SARB+	703-11AN+	703-12XBD+	703-13TBR+

Additional Adult Cuff Color Options

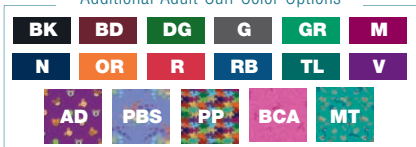

NOTE: To ensure correct cuff color when ordering, add color suffix to model number (e.g., 703-11ADG)

+ Also available with one-piece **Adcuff+** add "1" suffix to model number (e.g., 703-11AN1)





Gold-plated model now available
700-11AGP



Luminescent Dial

Diagnostix™ 700 Series

Our finest pocket aneroid, the 700 is the instrument of choice for the discriminating professional.

The 700 series features

- Chrome-plated, precision-crafted 300mmHg manometer; exceeds ANSI/AAMI/ISO 81060-1 specifications for accuracy and is backed by a lifetime calibration warranty
- Luminescent dial features bold numerals and extended graduation marks for easy reading in all light conditions and from virtually any angle
- Adcuff™ nylon cuff with ADC's proprietary Size Guide™ marking system prevents miscuffing
- Adflow™ filter screen check and deflation valves reduce dust buildup
- Adflow™ chrome-plated brass air-release valve with micro-threads for precise deflation control
- Leatherette carry case with durable nylon zipper
- Assembled, inspected, and packaged in the USA from foreign components



Extended scaleplate graduation marks reduce parallax for clear viewing from any angle.



Precision-crafted, Japanese-engineered manometer movement tested to 30,000 cycles.

Ordering Information

Infant	Child	Sm. Adult	Adult	Lg. Adult	Thigh
700-7BK	700-9CBK	700-10SABK	700-11ABK	700-12XBK	700-13TBK
700-71OR+	700-9CGR+	700-10SARB+	700-11AN+	700-12XBD+	700-13TBR+
			700-11AGP		

Additional Adult Cuff Color Options

BK	BD	DG	G	GP	GR	M
N	OR	R	RB	TL	V	
AD	PBS	PP	BCA	MT		

NOTE: To ensure correct cuff color when ordering, add color suffix to model number (e.g., 700-11ARB)

+ Also available with one-piece **Adcuff+** add "1" suffix to model number (e.g., 700-11AN1)



ADCUFF+
option
NOW
available



Tactical model
now available
720-11AST



Extended scaleplate graduation marks reduce parallax for clear viewing from any angle.



Precision-crafted, Japanese-engineered manometer movement tested to 30,000 cycles.

Diagnostix™ 720 Series

Offering more features than any other sphyg in its class, the 720 provides our finest value.

The 720 series features

- Precision-crafted 300mmHg Japanese-engineered manometer with classic black baked-enamel finish, exceeds ANSI/AAMI/ISO 81060-1 specifications for accuracy and is backed by a lifetime calibration warranty
- Extended scaleplate graduation marks reduce parallax for easier viewing from virtually any angle
- Adcuff™ nylon cuff with ADC's proprietary Size Guide™ marking system prevents miscuffing
- Adflow™ filter screen check and deflation valve reduce dust buildup
- Adflow™ chrome-plated brass air-release valve with micro-threads for precise deflation control
- Leatherette carry case with durable nylon zipper
- Assembled, inspected, and packaged in the USA from foreign components

Ordering Information

Infant	Child	Sm. Adult	Adult	Lg. Adult	Thigh
720-7IBK	720-9CBK	720-10SABK	720-11ABK	720-12XBK	720-13TBK
720-7IOR+	720-9CGR+	720-10SARB+	720-11AN+	720-12XBD+	720-13TBR+
			720-11AST		

Additional Adult Cuff Color Options

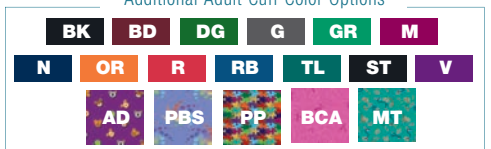

NOTE: To ensure correct cuff color when ordering, add color suffix to model number (e.g., 720-11ARB)

+ Also available with one-piece **Adcuff+** add "1" suffix to model number (e.g., 720-11AN1)





Prosplyg™ 760 Series

Our most popular aneroid, the 760 is the model of choice for demanding institutions.

The 760 series features

- Contemporary black enamel 300mmHg manometer provides day-in, day-out dependability that exceeds ANSI/AAMI/ISO 81060-1 specifications for accuracy
- Adcuff™ nylon cuff with ADC's proprietary Size Guide™ marking system prevents miscuffing
- Chrome-plated brass air-release valve
- Leatherette carry case with durable nylon zipper
- Assembled, inspected, and packaged in the USA from foreign components



Precision-crafted, Japanese-engineered manometer movement tested to 30,000 cycles.

Ordering Information

Infant	Child	Sm. Adult	Adult	Lg. Adult	Thigh
760-7IBK	760-9CBK	760-10SABK	760-11ABK	760-12XBK	760-13TBK
760-7IN	760-9CN	760-10SAN	760-11AN	760-12XN	760-13TN
760-7IOR	760-9COR	760-10SAOR	760-11AOR	760-12XOR	760-13TOR
760-7IOR	760-9CGR	760-10SARB	760-11AN	760-12XBD	760-13TBR

Additional Adult Cuff Color Options



NOTE: To ensure correct cuff color when ordering, add color suffix to model number (e.g., 760-11ARB)



Prosphyg™ 775 Series

An economical aneroid sphygmomanometer.

- Black enamel 300mmHg manometer exceeds ANSI/AAMI/ISO 81060-1 specifications for accuracy and is backed by a ten-year calibration warranty
- Navy blue nylon cuff with gauge holder and range markings
- Inflation bladder and bulb made without natural rubber latex or phthalates
- Chrome-plated deflation valve
- Includes leatherette zippered carry case
- Assembled, inspected, and packaged in the USA from foreign components



Ordering Information

Infant	Child	Sm. Adult	Adult	Lg. Adult	Thigh
N/A	775-9CN	775-10SAN	775-11AN	775-12XN	775-13TN



Prosphyg™ 770 Series

Ideal for the budget conscious.

- Black enamel 300mmHg manometer exceeds ANSI/AAMI/ISO 81060-1 specifications for accuracy and is backed by a ten-year calibration warranty
- Gray cotton cuff with artery label and gauge holder
- Inflation bladder and bulb made without natural rubber latex or phthalates
- Chrome-plated deflation valve
- Includes leatherette zippered carry case
- Assembled, inspected, and packaged in the USA from foreign components

Ordering Information

Infant	Child	Sm. Adult	Adult	Lg. Adult	Thigh
N/A	N/A	N/A	770-11AG	N/A	N/A



Prosphyg™ 774 SPU

A complete disposable sphygmomanometer.

- 100% leak tested to assure dependability
- Two-tube design with our 809SPU gauge and our 875PLF bulb and valve
- Rounded corners and soft, woven construction
- Meets or exceeds ANSI/AAMI/ISO 81060-1

Ordering Information

Infant	Child	Sm. Adult	Adult	Lg. Adult	Thigh
N/A	N/A	774-10SADH	774-11ADH	774-12XDH	N/A





Diagnostix™ 720 Bariatric Sphyg

Our specially designed bariatric sphygmomanometer provides a cost-effective solution to the challenges of measuring blood pressure on severely obese or bariatric patients.

The 720 bariatric sphyg features

- Precision-crafted 300mmHg Japanese-engineered manometer with classic black baked-enamel finish, exceeds industry performance standards
- Extended scaleplate graduation marks reduce parallax for easier viewing from virtually any angle
- Adcuff™ nylon cuff with ADC's proprietary Size Guide™ marking system prevents miscuffing
- Fits limbs with a circumference of 44 cm to 66 cm
- Adflow™ oversized bulb and valve for faster inflation of the larger cuff
- Adflow™ filter screen check and deflation valve reduce dust buildup
- Adflow™ chrome-plated brass air-release valve with micro-threads for precise deflation control
- Leatherette carry case with durable nylon zipper
- Assembled, inspected, and packaged in the USA from foreign components



Extended scaleplate graduation marks reduce parallax for clear viewing from any angle.



Precision-crafted, Japanese-engineered manometer movement tested to 30,000 cycles.



Conical design allows for proper fitting of cuff on severely obese patients

Ordering Information

Item	Description
720-12BXBD	Diagnostix™ Sphygmomanometer, Bariatric



Diagnostix™ 865 Bariatric Inflation System

The 865 bariatric inflation system features

- Includes ADC's exclusive Adcuff™ nylon cuff featuring the Size Guide™ marking system
- Inflation bladder with one 50cm tube and one 25cm tube
- Oversized Adflow™ bulb and valve with filter-screen protection
- For use with most aneroid or mercurial blood pressure instruments
- Individually packaged
- Three-year warranty
- Male bayonet connector included (8974M)



Ordering Information

Item	Description
865-12BXBD	Diagnostix™ Inflation System, Bariatric



Diagnostix™ Bariatric Adcuff™ and Bladders 1-Tube / 2-Tube

The bariatric cuff and bladders feature

- Durable nylon construction
- Exclusive Size Guide™ marking system
- Inflation bladder with 50cm tubing (25cm on second tube)
- Individually packaged
- Three-year warranty
- Connectors not included

Ordering Information

Item	Description
845-12BXBD-1	Diagnostix™ Adcuff & Bladder, Bariatric. 1-Tube
845-12BXBD-2	Diagnostix™ Adcuff & Bladder, Bariatric. 2-Tube



Pro's Combos



Looking for a scaled-down set without a stethoscope?

Our Pro's Combo II can be purchased with just the aneroid and matching case. See page 28.



Pro's Combo II and V offer deluxe gift-box packaging!

ADC's Pro's Combos combine our most popular aneroid blood pressure instruments and best-selling stethoscopes in a premium, color-coordinated carry case. Choose from five distinct models.

- **Pro's Combo I Palm Aneroid Kit** (Model 788). Ideal for the pre-hospital professional, this model marries our virtually indestructible 703 series palm aneroid with an Adscope Sprague stethoscope.
- **Pro's Combo III Pocket Aneroid** (Model 778). For the discriminating professional who prefers a more traditional design, this model features the 700 series chrome-plated aneroid paired with an Adscope 603 dual-head clinician stethoscope.
- **Pro's Combo V Pocket Aneroid Kit** (Model 728). This combination starts with our 720 pocket aneroid, and includes our Adscope Lite 619 dual-head clinician stethoscope.
- **Pro's Combo II Pocket Aneroid Kit** (Model 768). Our original combo set is built with ADC's best-selling 760 aneroid and your choice of a lightweight Proscope or Adscope Sprague.
- **Pro's Combo IV Pocket Aneroid Kit** (Model 769). This style includes our best-selling 760 aneroid and an Adscope Sprague with additional instruments in a heavy-duty, color-matched nylon fanny pack.



ADCUFF+
option
NOW
available



Luminescent Dial



Zinc Cage Protects Movement.

Ambidextrous Trigger Valve.

Pro's Combo I™ Palm Aneroid Kit

The ideal kit for the demanding pre-hospital professional combines our best-selling palm aneroid and Sprague.

The 788 series features

- The 703 palm-style sphygmomanometer and color-coordinated matching professional Adscope® 641 Sprague (page 71)
- 804N gauge with integral bulb and trigger-style air-release valve for one-hand convenience, exceeds ANSI/AAMI/ISO 81060-1 specifications for accuracy and is backed by a lifetime calibration warranty
- Precision-crafted 300mmHg Japanese-engineered movement tested to 30,000 cycles
- Adcuff™ nylon cuff with ADC's proprietary Size Guide™ marking system
- Quick-release bayonet connector
- Extra-large, color-matched, dual-pocket nylon carry case (measures 9" x 5" x 2")
- Ideal for nurses, PA's, and EMT's
- Assembled, inspected, and packaged in the USA from foreign components

Ordering Information

Item	Description
788-11A**	Pro's Combo I Palm Aneroid (Adult Only)
788-641-11A**	Pro's Combo I Palm Aneroid/Sprague (Adult Only)

Additional Adult Cuff Color Options

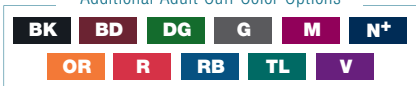

NOTE: To ensure correct cuff color when ordering, add color suffix to model number (e.g., 788-641-11AV)

+ Also available with one-piece **Adcuff+** add "1" suffix to model number (e.g., 788-641-11AN1)





Luminescent Dial

Pro's Combo III™ Pocket Aneroid Kit

A combination of our finest pocket aneroid and one of our most popular acoustic scopes. Together they provide outstanding performance with rugged durability.

The 778 series features

- Chrome-plated pocket aneroid (Diagnostix™ 700) with luminescent dial provides day-in, day-out dependability
- Manometer exceeds ANSI/AAMI/ISO 81060-1 specifications for accuracy and is backed by a lifetime calibration warranty
- Adcuff™ nylon cuff with ADC's proprietary Size Guide™ marking system prevents miscuffing
- Color-coordinated Adscope® 603 stethoscope (page 64) with AFD technology
- Extra-large, color-matched, dual-pocket nylon carry case
- Ideal for nurses, students, PA's, and EMT's
- Lifetime quality performance guarantee on Adscope™ 603
- Assembled, inspected, and packaged in the USA from foreign components



Extended scaleplate graduation marks reduce parallax for clear viewing from any angle.



Precision-crafted, Japanese-engineered manometer movement tested to 30,000 cycles.

Ordering Information

Item	Description
778-11A**	Pro's Combo III Pocket Aneroid (Adult Only)
778-603-11A**	Pro's Combo III Pocket Aneroid / Adscope™ 603 (Adult Only)

Additional Adult Cuff Color Options

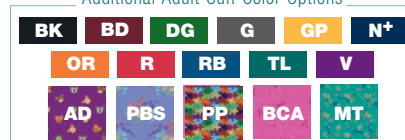

NOTE: To ensure correct cuff color when ordering, add color suffix to model number (e.g., 778-11ADG)

+ Also available with one-piece **Adcuff+** add "1" suffix to model number (e.g., 778-11AN1)





Extended scaleplate graduation marks reduce parallax for clear viewing from any angle.

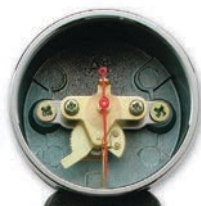

Precision-crafted, Japanese-engineered manometer movement tested to 30,000 cycles.

Pro's Combo V™ Pocket Aneroid Kit

A kit containing our 720 series sphyg — one of our finest and most popular pocket aneroids — and the all-new Adscope® Lite 619 stethoscope in a color-coordinated, extra-large carry case.

The 728-619 series features

- Premium aneroid manometer that exceeds ANSI/AAMI/ISO 81060-1 specifications for accuracy, backed by a lifetime calibration warranty
- Adcuff™ nylon cuff with ADC's proprietary Size Guide™ marking system prevents miscuffing and is color matched to the scope and case
- Color-coordinated, Adscope Lite 619 stethoscope (page 65)
- Extra-large, color-matched, dual-pocket nylon carry case
- Ideal for nurses, students, PA's, and EMT's
- Lifetime warranty on Adscope Lite, lifetime calibration warranty and three-year warranty on Adcuff™ inflation system
- Assembled, inspected, and packaged in the USA from foreign components

Ordering Information

Item	Description
728-619-11A**	Pro's Combo™ V Aneroid / Adscope Lite™ Kit (Adult Only)

Additional Adult Cuff Color Options

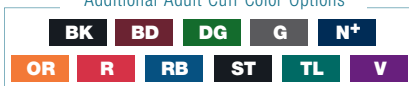

NOTE: To ensure correct cuff color when ordering, add color suffix to model number (e.g., 728-619-11AV)

+ Also available with one-piece **Adcuff+** add "1" suffix to model number (e.g., 728-619-11AN1)





768-641-11A**



768-11A**



768-670-11A**

Pro's Combo II™ Pocket Aneroid Kit

A professional kit that combines our best-selling aneroid with an optional stethoscope in a color-coordinated premium nylon case.

The 768 series features

- Contemporary black enamel 300mmHg manometer exceeds ANSI/AAMI/ISO 81060-1 specifications for accuracy
- Adcuff™ calibrated nylon cuff with ADC's proprietary Size Guide™ marking system prevents miscuffing
- Chrome-plated deflation valve
- Extra-large, color-matched, dual-pocket nylon carry case, measures 9" x 5" x 2"
- Assembled, inspected, and packaged in the USA from foreign components

Pro's Combo II™ 768 series includes

- Complete aneroid and matching case

Pro's Combo II™ Dualhead 768-670 series includes

- Complete aneroid, matching case, and color-matched Proscope™ dualhead stethoscope (see page 75)

Pro's Combo II™ Sprague 768-641 series includes

- Complete aneroid, matching case, and color-matched Sprague stethoscope (see page 71)

Ordering Information

Item	Description
768-11A**	Pro's Combo II Aneroid (Adult)
768-9C**	Pro's Combo II Aneroid (Child), AD, PP
768-10SA**	Pro's Combo II Aneroid (Sm. Adult), AD, PP
768-670-11A**	Pro's Combo II Dualhead Kit (Adult Only)
768-641-11A**	Pro's Combo II Sprague Kit (Adult)
768-641-9C**	Pro's Combo II Sprague Kit (Child), AD, PP
768-641-10SA**	Pro's Combo II Sprague Kit (Sm. Adult), AD, PP

Additional Adult Cuff Color Options



NOTE: To ensure correct cuff color when ordering, add color suffix to model number (e.g., 768-11AV)





Pro's Combo IV™ Fanny Pack Kit

Combines our best-selling 760 series aneroid, an Adscope® 641 Sprague, legendary Medicut® shears, and an Adlite™ penlight in a color-coordinated, heavy-duty, multipocket nylon fanny pack.

The 769-641 series features

- Premium aneroid manometer with black enamel finish that exceeds ANSI/AAMI/ISO 81060-1 specifications for accuracy and is backed by a 20-year calibration warranty
- Adcuff™ nylon cuff with ADC's proprietary Size Guide™ marking system prevents miscuffing and is color-matched to the scope and case
- Color-coordinated Adscope™ 641 Sprague (see page 71) with ADC's proprietary valve mechanism and gasket-sealed chestpiece
- Color-coordinated Medicut™ 7¼" shears with one serrated edge
- Adlite™ disposable diagnostic penlight
- Color-matched, 600-denier nylon fanny pack with three zippered compartments, two interior mesh pockets, and elastic retaining straps. Measures 10¼" x 6" x 3", fits waists 20" - 56"
- Five-year quality performance guarantee on Sprague, 20-year calibration warranty, and three-year warranty on Adcuff™ inflation system
- Assembled, inspected, and packaged in the USA from foreign components

Ordering Information

Item	Description
769-641-11A**	Pro's Combo™ IV Fanny Pack Kit (Adult Only)

Additional Adult Cuff Color Options



NOTE: To ensure correct cuff color when ordering, add color suffix to model number (e.g., 769-641-11ABK)



Multicuff Systems



Single color cuffs and multi-color models available.
Offered in infant, child, and adult sizes.

ADC's multicuff blood pressure systems combine versatility, convenience, and value. Each set includes a palm aneroid gauge, a range of cuff sizes, and compartmentalized storage solutions optimized for both in-office and on-the-go environments.

At the heart of every multicuff system is our 804N palm aneroid. With its protective zinc cage, high-impact ABS housing, ambidextrous infinite-control air-release valve, and a precision-crafted, Japanese-engineered movement tested to 30,000 cycles, the 804N is the finest palm-style manometer available.

Sets come with 3, 4, or 5 blood pressure cuffs, all featuring the ADC Adcuff proprietary Size Guide™ marking system. Select models are also available with our new one-piece bladderless Adcuff+ cuffs. Sizes range from Infant to Large Adult and Thigh.



General Practice Kit
Designed for the busy office, clinic, or emergency room



System 5™ and Multikuff™
Compact, portable kits that fit in most emergency bags

ADCUFF+
option
NOW
available



Luminescent
Dial

General Practice Kit
705GPK-MCC



Pediatric Kit
705PMK-MCC

Ordering Information

705GPK-BK	Small Adult	Adult	Large Adult
705GPK-N	Small Adult	Adult	Large Adult
705GPK-MCC+	Small Adult	Adult	Large Adult
705PMK-BK	Infant	Child	Small Adult
705PMK-N	Infant	Child	Small Adult
705PMK-MCC+	Infant	Child	Small Adult
705PMK-PRT	Child	Small Adult	Adult

NOTE: To ensure correct cuff color when ordering,
add color suffix to model number (e.g., 705GPK-BK)

+ Also available with one-piece **Adcuff+**
add "1" suffix to model number (e.g., 705GPK-MCC1)



General Practice Multicuff Kit
A multicuff kit designed for the
busy office, clinic, or ER.



Zinc Cage
Protects Movement.



Ambidextrous
Trigger Valve.

The 705 series features

- ADC 804N palm gauge plus three cuffs with one-tube bladders
- Rugged gauge features precision-crafted, Japanese-engineered movement tested to 30,000 cycles
- Manometer exceeds ANSI/AAMI/ISO 81060-1 specifications for accuracy, backed by a lifetime calibration warranty
- Ambidextrous, trigger-release air valve
- Quick-release bayonet connectors for rapid selection of appropriate cuff
- Four-section, smoke-gray plexiglass tray features a small 14" x 3½" footprint
- Tray may be wall mounted with included hardware
- Assembled, inspected, and packaged in the USA from foreign components

General Practice Multicuff Kit includes

- Small Adult, Adult, and Large Adult calibrated nylon Adcuffs™

Pediatric Multicuff Kit includes

- Infant, Child, and Small Adult calibrated nylon Adcuffs™



Luminescent Dial



Multikuf™ BP System, 4 Cuff
732-BK



Zinc Cage
Protects Movement.



Ambidextrous
Trigger Valve.

Multikuf™

The most compact multicuff kit system available.

The Multikuf™ features

- A multi-pocketed, heavy-duty, black nylon zipper case that keeps each component securely in place, yet instantly accessible
- Case measures a compact 8" x 6" x 3.5" and can easily be stored in most emergency boxes or trauma bags
- Three-cuff model includes Adult, Small Adult, and Large Adult Adcuffs™ with one-tube bladder with quick-release bayonet connector
- Four-cuff model also includes Child cuff
- Features our 804N palm gauge with integrated, infinite-controlled, ambidextrous trigger-release air valve
- Manometer exceeds ANSI/AAMI/ISO 81060-1 specifications for accuracy, backed by a lifetime calibration warranty
- 804N utilizes a Japanese-engineered movement housed in a zinc safety cage within its rugged ABS housing
- Assembled, inspected, and packaged in the USA from foreign components

Ordering Information

Multikuf™ BP System, 3 Cuff

731-BK	Small Adult	Adult	Large Adult
731-N	Small Adult	Adult	Large Adult
731-OR	Small Adult	Adult	Large Adult
731-MCC+	Small Adult	Adult	Large Adult

Multikuf™ BP System, 4 Cuff

732-BK	Child	Small Adult	Adult	Large Adult
732-N	Child	Small Adult	Adult	Large Adult
732-OR	Child	Small Adult	Adult	Large Adult
732-MCC+	Child	Small Adult	Adult	Large Adult

NOTE: To ensure correct cuff color when ordering, add color suffix to model number (e.g., 731-BK)

+ Also available with one-piece Adcuff+ add "1" suffix to model number (e.g., 731-MCC1)



ADCUFF+[™]
option
NOW
available



System 5™
740-OR

System 5™
740-N



Luminescent
Dial



Zinc Cage
Protects Movement.

Ambidextrous
Trigger Valve.

System 5™

The most compact, ergonomically designed, and affordably priced 5-cuff blood pressure system on the market today.

The System 5™ features

- A multi-pocketed, heavy-duty 600D nylon attaché style case that keeps each component securely in place, yet instantly accessible
- Dual-zipper closure for rapid access. Protects against the elements
- Measures a compact 10" x 9" x 4" when closed, weighs just 2½ lbs (680.3 g)
- Compact enough to fit in most emergency bags or trauma boxes
- Reinforced carry handle allows for wall mounting in the open position
- Includes Child, Small Adult, Adult, Large Adult, and Thigh Adcuff™ nylon cuffs, featuring ADC's Size Guide™ marking system
- Quick-release bayonet connector permits rapid selection of the appropriate cuff
- Revolutionary Diagnostix™ 804N palm style manometer with precision Japanese-engineered movement rated to 30,000 cycles
- Manometer exceeds ANSI/AAMI/ISO 81060-1 specifications for accuracy, backed by a lifetime calibration warranty
- Ambidextrous trigger-release air valve
- Assembled, inspected, and packaged in the USA from foreign components

Ordering Information

740-N	Child	Small Adult	Adult	Large Adult	Thigh
740-OR	Child	Small Adult	Adult	Large Adult	Thigh
740-MCC+	Child	Small Adult	Adult	Large Adult	Thigh

NOTE: To ensure correct cuff color when ordering, add color suffix to model number (e.g., 740-N)

+ Also available with one-piece **Adcuff+** add "1" suffix to model number (e.g., 740-MCC1)



Clock Face Aneroids



ADC's clock aneroid is built with a special internal air restrictor to reduce the "needle bounce" that can cause lesser-built models to lose calibration.

ADC's Diagnostix brand clock face aneroid is the ideal blood pressure monitoring instrument for institutional use. Newly restyled, the gauge features a high-impact housing that protects the movement, with a dove-white bezel around the crystal for a more finished look.

- **Six-inch luminescent beveled dial is easy to read, even in low-light conditions**
- **Generous coiled tubing extends to eight feet in length**
- **Adcuff blood pressure cuffs available in six clinical sizes**
- **Three-year inflation system warranty**
- **Lifetime calibration warranty**

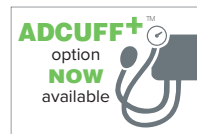

Select models are available with our new one-piece bladderless cuffs.

Look for a + symbol in the ordering table on page 35.



Wall mount, desk stand, and mobile configurations available.



New Integrated Basket

Our newly redesigned storage basket with integrated keeps cuffs and cords neat when not in use, while allowing 110° rotation for optimal viewing. Included on wall, Adstation, and desk models.



ADCUFF+
option
NOW
available

750W

750D



Luminescent Dial



Beveled Face

*Some assembly required

Diagnostix™ 750 Series

A large-face aneroid available in three configurations that offer the superb precision, styling, and dependability synonymous with the ADC name.

The 750 series features

- Large, easy-to-read, 6" luminescent dial for high visibility in virtually any light condition
- 300mmHg no-pin stop movement withstands the heaviest use
- Manometer exceeds ANSI/AAMI/ISO 81060-1 specifications for accuracy, backed by a lifetime calibration warranty
- Inflation system includes the Adcuff™ nylon cuff, Adflow™ bulb and valve, and eight-foot length (when extended) coiled tubing
- Contemporary casing in winter white with framed crystal bezel.
- Complete with all necessary hardware and assembly instructions
- Available in wall, desk, or mobile configurations
- Assembled, inspected, and packaged in the USA from foreign components

The 750W wall aneroid includes

- Compact, integrated rear basket with room for inflation system and extra cuffs
- Integrated swivel mount that allows 110° rotation for optimal viewing
- Fully assembled with hardware and hanging instructions

The 750D desk aneroid includes

- Fully assembled tabletop stand with compact, integrated basket for storage and integrated swivel mount for 110° viewing rotation

The 752M mobile aneroid includes

- Height-adjustable Spider-Leg™ stand in white, with overall range of 34" to 48" (from bottom of base to top of unit)
- Five black casters, two with locking brakes
- Roomy basket holds multiple cuffs
- Manometer angled back 15° for easy viewing
- 18" base diameter

Ordering Information

752M - Mobile Series

Infant	Child	Sm. Adult	Adult	Lg. Adult	Thigh
752M-7IBK	752M-9CBK	752M-10SABK	752M-11ABK	752M-12XBK	752M-13TBK
752M-7IOR+	752M-9CGR+	752M-10SARB+	752M-11AN+	752M-12XBD+	752M-13TBR+

750D - Desk Series

Infant	Child	Sm. Adult	Adult	Lg. Adult	Thigh
750D-7IBK	750D-9CBK	750D-10SABK	750D-11ABK	750D-12XBK	750D-13TBK
750D-7IOR+	750D-9CGR+	750D-10SARB+	750D-11AN+	750D-12XBD+	750D-13TBR+

750W - Wall Series

Infant	Child	Sm. Adult	Adult	Lg. Adult	Thigh
750W-7IBK	750W-9CBK	750W-10SABK	750W-11ABK	750W-12XBK	750W-13TBK
750W-7IOR+	750W-9CGR+	750W-10SARB+	750W-11AN+	750W-12XBD+	750W-13TBR+

NOTE: To ensure correct cuff color when ordering, add color suffix to model number (e.g., 752M-11ABK)

+ Also available with one-piece **Adcuff+** add "1" suffix to model number (e.g., 750W-7IOR1)



Home Blood Pressure



Smart Logic™ technology, available on many Advantage home blood pressure monitors, sets the ideal inflation level automatically.









ADC offers home blood pressure units under both our Prosplyg™ and our Advantage™ brands.

Our feature-rich mechanical and digital **Advantage** blood pressure monitors are offered in manual, upper-arm digital, and wrist digital models. Digital units feature extra-large displays, blood pressure and pulse measurement, auto off, and memory. All are made without natural rubber latex or phthalates, and all offer a five-year warranty.

Prosplyg aneroid home kits are assembled in the U.S.A. and use many of the same components found in our professional-grade products. Choose from three models, each in three sizes, and each with a 5- or 10-year calibration warranty.



The Advantage Connect 6024N combines best-in class features with Bluetooth connectivity and our free ADC@Home App. See page 37.

	6024N	6021N/NSA/NX	6016N	6015N	6012N	6005	780	790	785
Model	 Page 37	 Page 38	 Page 39	 Page 39	 Page 38	 Page 40	 Page 40	 Page 40	 Page 40
Type	Digital Arm	Digital Arm	Digital Wrist	Digital Wrist	Digital Arm	Aneroid	Aneroid	Aneroid	Aneroid
Inflation	Auto	Auto	Auto	Auto	Manual	Manual	Manual	Manual	Manual
Smart Logic	N/A	Yes	Yes	Yes	N/A	N/A	N/A	N/A	N/A
Deflation	Auto Electric	Auto Electric	Auto Electric	Auto Electric	Auto Electric	Auto Valve	Manual	Manual	Manual
Scope Included	N/A	N/A	N/A	N/A	N/A	Attached	Yes	Attached	No
Pulse	Yes	Yes	Yes	Yes	Yes	N/A	N/A	N/A	N/A
Memory	2X 99	2X 99	2X 99	2X 99	Last Reading	N/A	N/A	N/A	N/A
Battery	4 AAA	4 AA	2 AAA	2 AAA	4 AA	N/A	N/A	N/A	N/A
Connected	Bluetooth w App	No	PC Link	No	No	N/A	N/A	N/A	N/A
AC Adapter	No	Optional	No	No	No	N/A	N/A	N/A	N/A
Warranty	5 Year	5 Year	5 Year	5 Year	5 Year	1 Year	1 Year	1 Year	1 Year



Advantage™ Connect 6024N

ADC's all-new Advantage Connect 6024N is an upper-arm digital home blood pressure monitor that combines best-in-class features with Bluetooth connectivity.

The 6024N features

- Systolic pressure, diastolic pressure, and pulse readings
- Wireless Bluetooth connectivity allows you to pair the unit with our free ADC@Home App and seamlessly transfer data and readings to your smartphone or hand-held device
- Measurement performed on inflation for faster, more comfortable readings
- British Hypertension Society (BHS) AA rating* ensure accuracy
- MAM Advantage™ mode automatically averages three readings for superior reporting accuracy
- Irregular heartbeat detection offers warning signal at the appearance of an irregular heartbeat
- Traffic light indicator visualizes readings against national standards
- Displays AM and PM readings separately to help detect morning hypertension
- Advanced two-zone memory with date and time stamp recalls last 99 readings for two users

*On equivalent model

- Soft, self-adjusting, wide-range D-bar cuff (Adult) fits arm ranges from 8.7" to 16.5" (22 cm to 42 cm)
- Auto-off to conserve batteries; four AAA batteries included
- Meets or exceeds EN 1060-1, EN 1060-3, and EN 1060-4
- 5-year warranty

Pair with our proprietary ADC@Home™ app, available at no cost from the Apple® App Store® and Google Play™ store, to:

- Capture, graph, and store blood pressure readings over time
- Visually compare readings with American Heart Association guidelines
- Share readings via email with your healthcare providers
- Set daily reading reminders
- Integrate your data with other health apps

Ordering Information

Item	Description
------	-------------

6024N	Advantage™ Connect Digital BP Monitor, Adult
--------------	--

 This item is not available for sale in Canada





Advantage™ 6021N Automatic BP Monitor

Smart Logic™ technology for the ultimate in simplicity.

The 6021N features

- Systolic pressure, diastolic pressure, and pulse readings
- British Hypertension Society AA rating* ensures accuracy
- Automatic inflation and deflation control with Smart Logic™ Technology for the ideal inflation level
- Irregular heartbeat detector
- Recalls last 99 readings with date and time stamp for two users
- Soft self-adjusting, extended wide-range Adult D-Bar cuff fits arm ranges from 8.7" to 16.5" (22 cm to 42 cm)
- Auto off
- Deluxe storage case
- Optional AC adapter (sold separately)

*On equivalent model

Ordering Information

Item	Description
6021NSA	Advantage™ Digital BP Monitor, Small Adult
6021N	Advantage™ Digital BP Monitor, Adult
6021NX	Advantage™ Digital BP Monitor, Lg. Adult
6023NZAC	Advantage™ AC Adapter

 These items are not available for sale in Canada



Advantage™ 6012N Semi-Automatic BP Monitor

Compact and easy to use.

The 6012N features

- Systolic pressure, diastolic pressure, and pulse readings
- Manual inflation
- Self-adjusting D-Bar adult cuff fits arm ranges from 8.7" to 12.6" (22 cm to 32 cm)
- Automatic deflation valve
- Auto shutoff

Ordering Information

Item	Description
6012N	Advantage™ Digital Blood Pressure Monitor

 This item is not available for sale in Canada



Advantage™ 6016N Digital Wrist BP Monitor

Our most feature-rich wrist digital home blood pressure monitor

The 6016N features

- Systolic pressure, diastolic pressure, and pulse readings
- British Hypertension Society AA rating* ensures accuracy
- Smart Logic™ technology determines ideal inflation level
- MAM Advantage™ average mode automatically averages three readings for superior reporting accuracy
- Advanced two-zone memory with date and time stamp recalls last 99 readings for two different people
- Optional PC Link Analyzer Software (sold separately) connects your blood pressure monitor to your PC to download and print data, graphs, charts, and tables of your readings
- Wrist cuff fits 5.3" to 7.7" (13.5-19.5 cm) wrists
- Auto off
- Two AAA batteries included
- Compact storage case
- Meets or exceeds EN 1060-1 and EN 1060-3
- Five-year warranty

*On equivalent model



Ordering Information

Item	Description
6016N	Advantage™ Ultra Digital BP Monitor
6023NPC	Advantage™ PC Software with USB Cable

These items are not available for sale in Canada



Advantage™ 6015N Digital Wrist BP Monitor

With Smart Logic™ technology and an advanced memory, the Advantage™ 6015N is our most popular wrist digital home blood pressure monitor.

The 6015N features

- Systolic pressure, diastolic pressure, and pulse readings
- British Hypertension Society AA rating* ensures accuracy
- Smart Logic™ technology determines ideal inflation level
- Recalls last 99 readings for two users
- Wrist cuff fits 5.3" to 7.7" (13.5-19.5 cm) wrists
- Auto off
- Two AAA batteries included
- Compact storage case
- Meets or exceeds EN 1060-1 and EN 1060-3
- Five-year warranty

*On equivalent model

Ordering Information

Item	Description
6015N	Advantage™ Digital BP Monitor

This item is not available for sale in Canada



Prosphyg™ 780/790 Series

Our most popular homecare models combine quality construction with ease of use.

The Prosphyg™ 780/790 series features

- Black enamel 300mmHg manometer
- Chrome-plated deflation valve
- Zippered carry case and operating instructions
- Assembled, inspected, and packaged in the USA from foreign components

The 780 series includes

- Nylon, D-Bar, self-adjusting cuff for one-handed cuff application
- Diaphragm-only blood pressure scope with black PVC tubing (660BK)

The 790 series includes

- Nylon, D-Bar, self-adjusting cuff with attached diaphragm-only scope for one-handed use
- Scope features adjustable aluminum binaurals and black 22" PVC tubing



Ordering Information

780 Series		
Sm. Adult	Adult	Lg. Adult
780-10SAN	780-11AN	780-12XN

790 Series		
Sm. Adult	Adult	Lg. Adult
790-10SAN	790-11AN	790-12XN



Prosphyg™ 785 Series

The 785 series utilizes a D-Bar self-adjusting cuff for one-handed application.

The 785 series features

- Black enamel 300mmHg manometer
- Nylon, D-Bar, self-adjusting cuff for one-handed cuff application
- Chrome-plated deflation valve
- Complete with leatherette zippered carry case and operating instructions
- Assembled, inspected, and packaged in the USA from foreign components

Ordering Information

Sm. Adult	Adult	Lg. Adult
785-10SAN	785-11AN	785-12XN



Advantage™ 6005 Manual BP Kit

The most feature-rich manual kit on the market.

The 6005 features

- Dial with bold, white numerals on black face for easy reading
- Self-adjusting, D-Bar Adcuff™ for Home™ for one-handed application
- Size Guide™ marking system ensures optimal accuracy
- Auto-deflation valve
- Attached nurse scope
- Zippered carry case and operating instructions

Ordering Information

Item	Description
6005	Advantage™ 6005 Manual BP Kit Adult, Black only



Advantage™ Digital BP Replacement Parts

Specially designed inflation system components for use with Advantage™ Digital Monitors.



878



850-6012N



850-6021NSA



850-6022N



850-6022NX



850-6023N

See digital models in chart below for cuff dimensions and limb ranges

Ordering Information

Item	Description
6021NCASE	Carry Case for 6021N, 6022N
6023NCASE	Carry Case for 6023N
6023NPC	PC Software for 6016N, 6022N, 6023N
6023NZAC	AC Adapter for 6021N, 6022N, 6023N
850-6012N	Adult Cuff for 6012N
850-6021NSA	Small Adult Cuff for 6021NSA, 6021N, 6024
850-6022N	Wide-range Soft Cuff for 6021N, 6021NX, 6022N, 6023N, 6024
850-6022NX	Large Adult Cuff for 6012N, 6021N, 6021NX, 6022N, 6023N, 6024
850-6023N	Wide-range Rigid Cuff for 6023N
878	Bulb and Valve for 6005, 6012N

NOTE: Not all cuffs can be applied to all units.
The 6022N and 6023N have been discontinued.

Homecare Cuff Dimensions

845-790, 845-780 Series

Manual Models

Cuff	Cuff Dimensions		Applicable Limb Range	
	Cm	In	Cm	In
Sm. Adult	10.2 x 38.1	4.0 x 15.0	16.0 to 25.0	6.3 to 9.8
Adult	14.3 x 50.2	5.6 x 19.7	23.0 to 34.0	9.0 to 13.3
Lg. Adult	17.2 x 61.6	6.7 x 24.2	30.0 to 40.0	11.8 to 15.7

Note: Home Care Models use the same bladder as the corresponding size Adcuff™
Only available in Adult, Large Adult, and Small Adult.

Note: Digital Models use non-replaceable bladders
Only available in Adult, Large Adult, and Small Adult.

Digital Models

Cuff	Cuff Dimensions		Applicable Limb Range	
	Cm	In	Cm	In
Sm. Adult	11.5 x 35.0	4.5 x 18.7	17.0 to 22.0	6.7 to 8.7
Adult 6012N	14.0 x 49.0	5.6 x 19.7	22.0 to 32.0	8.7 to 12.6
Adult 6021N	15.0 x 60.0	5.9 x 23.6	22.0 to 42.0	8.7 to 16.5
Adult 6024N	15.0 x 60.0	5.9 x 23.6	22.0 to 46.0	8.7 to 18.1
Lg. Adult	17.0 x 61.0	6.7 x 24.2	32.0 to 52.0	12.5 to 20.4

Adcuff™ and Bladder Dimensions

845-1, 845-2 Series

Cuff	Bladder Dimensions		Cuff Dimensions		Applicable Limb Range		
	Size	Cm	In	Cm	In	Cm	In
Infant	7I	4.0 x 8.0	1.6 x 3.2	5.2 x 18.1	2.0 x 7.1	9.0 to 14.0	3.5 to 5.5
Child	9C	5.5 x 11.5	2.2 x 4.5	7.5 x 26.1	3.0 x 10.3	13.0 to 19.5	5.1 to 7.6
Sm. Adult	10SA	8.5 x 17.0	3.3 x 6.7	10.5 x 34.2	4.1 x 13.5	19.0 to 27.0	7.4 to 10.6
Adult	11A	12.0 x 22.5	4.7 x 8.9	14.5 x 54.0	5.7 x 21.3	23.0 to 40.0	9.0 to 15.7
Lg. Adult	12X	14.5 x 32.0	5.7 x 12.6	17.6 x 63.3	6.9 x 24.9	34.0 to 50.0	13.3 to 19.6
Thigh	13T	18.5 x 38.0	7.3 x 15	21.0 x 82.5	8.3 x 32.5	40.0 to 66.0	15.7 to 25.9
Bariatric	12BX	18.5 x 38.0	7.3 x 15	109.0 x 28.6	43 x 11.2	44.0 to 66.0	17.32 to 25.9



Limb ranges for Adcuff+ cuffs are the same as for traditional Adcuff cuffs, with the exception of Infant size, which fits up to 14.8 cm (5.8 in).

SPU Cuffs and Accessories



Adcuff SPU cuffs are available in adult, child, and neonatal sizes and are 100% leak tested to assure dependability.

ADC's Adcuff™ SPU series of single patient-use blood pressure cuffs offers increased simplicity, accuracy, comfort, and value.

Made from a woven polyester fabric (without natural rubber latex or phthalates), the color-coded cuffs are exceptionally soft and comfortable.

Choose from a one-tube configuration with a bayonet connector or a two-tube configuration with a screw connector.



Standardized adapters simplify purchasing and inventory management while ensuring compatibility with most monitors. See page 48.

Strong Hook-and-Loop Adhesive

withstands repeated open/close cycles

Range Markings

for accurate sizing, minimizes risk of miscuffing

Size Icons and Color Coding

for quick visualization of selected cuff

Curved Corners

for greater patient comfort

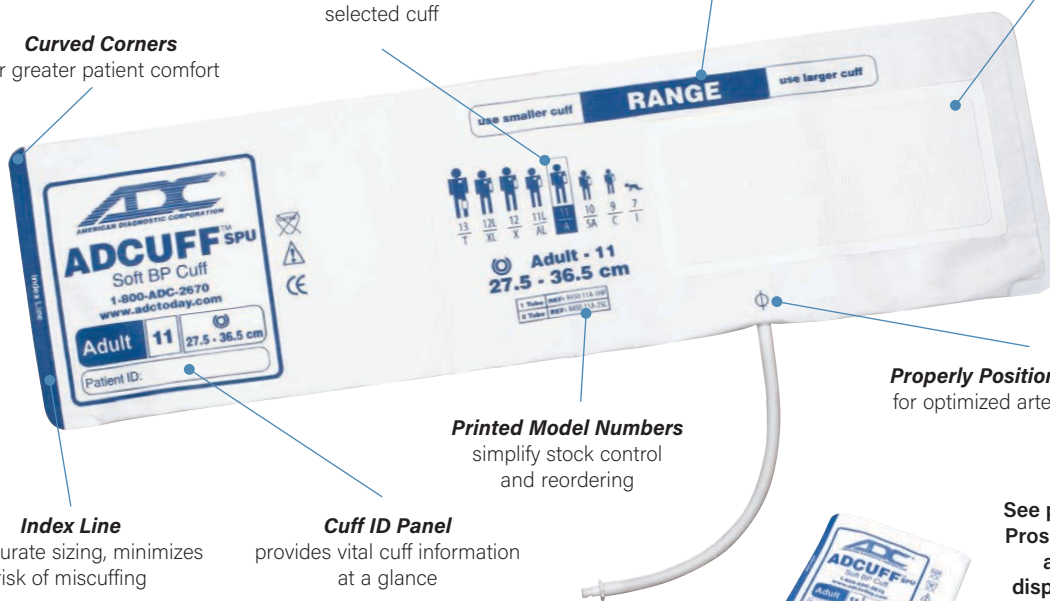

Properly Positioned Artery Mark

for optimized arterial compression

Printed Model Numbers

simplify stock control and reordering

Index Line

for accurate sizing, minimizes risk of miscuffing

Cuff ID Panel

provides vital cuff information at a glance

See page 21 for our Prosplyg 774 SPU, a complete disposable sphyg







ADCUFF™ SPU Blood Pressure Cuffs

Our line of SPU cuffs are economical enough for single-patient application yet durable enough for repeated use.

- 100% leak tested to assure dependability
- Thirteen clinical sizes for neonatal, child, and adult patients
- The industry's most precise cuff markings
- Rounded corners and soft, woven construction
- Color-coded for quick visualization of correct size
- One-tube with bayonet-type (HP) connector
- Two-tube with screw-type (Dinamap) connector
- Neonatal cuffs with Luer connector
- Standardized connectors for inventory management
- Compatible with most brands of monitors

Ordering Information

	Connector	Infant	Child	Sm. Adult	Adult	Adult Long	Lg. Adult	Lg. Adult Long	Thigh
Range (cm)	N/A	9-14.8	13.8-21.5	20.5-28.5	27.5-36.5	27.5-40	35.5-46	35.5-50	45-56.5
Color	N/A	Orange	Green	Royal Blue	Navy	Navy	Burgundy	Burgundy	Brown
One-Tube	None	8450-7I-1	8450-9C-1	8450-10SA-1	8450-11A-1	8450-11AL-1	8450-12X-1	8450-12XL-1	8450-13T-1
One-Tube	Bayonet (HP) 	8450-7I-1HP	8450-9C-1HP	8450-10SA-1HP	8450-11A-1HP	8450-11AL-1HP	8450-12X-1HP	8450-12XL-1HP	8450-13T-1HP
Two-Tube	None	8450-7I-2	8450-9C-2	8450-10SA-2	8450-11A-2	8450-11AL-2	8450-12X-2	8450-12XL-2	8450-13T-2
Two-Tube	Screw (Dinamap) 	8450-7I-2SC	8450-9C-2SC	8450-10SA-2SC	8450-11A-2SC	8450-11AL-2SC	8450-12X-2SC	8450-12XL-2SC	8450-13T-2SC
Inflation System*	None	8450-7I	8450-9C	8450-10SA	8450-11A	8450-11AL	8450-12X	8450-12XL	8450-13T

* Includes 875PLF bulb and valve

	Connector	Neonatal 1	Neonatal 2	Neonatal 3	Neonatal 4	Neonatal 5
Range (cm)	N/A	3-6	4-8	6-11	7-13	8-15
Color	N/A	Orange	Light Blue	Green	Navy	Burgundy
One-Tube	Luer Slip	8450-1N-1L	8450-2N-1L	8450-3N-1L	8450-4N-1L	8450-5N-1L
Two-Tube	Luer Slip	8450-1N-2L	8450-2N-2L	8450-3N-2L	8450-4N-2L	8450-5N-2L
Inflation System*	None	8450-7I	8450-2N-2L	8450-10SA	8450-11A	8450-11AL

* Includes 875PLF bulb and valve

Individually polybagged with:
 20 per package (child and adult sizes)
 10 per package (neonatal sizes)
 5 five per package (inflation systems)



Blood Pressure Parts



Gauges, inflation bulbs,
valves, cuffs, and more.

ADC brand sphygmomanometer replacement parts are compatible with most major brands of blood pressure instruments.

Components include precision-crafted Prosplyg™ and Diagnostix™ manometers, Adcuff™ cuffs and bladders with Size Guide™ marking system, and Adflow™ bulbs and valves.

Most components are individually packaged for greater stock control.



Diagnostix gauges are backed by
a lifetime calibration warranty

Prosplyg gauges offer
a 10- or 20-year
calibration warranty



Replacement parts for our
Advantage line of digital home
blood pressure can be found
on page 41.

Gauges

- 300mmHg no-pin stop
- Individually tested to conform to ANSI/AAMI/ISO 81060-1 standards
- All gauges individually packaged

Ordering Information

Item	Description
800	Gauge for 700, 778 Series
800GP	Gauge for 700-11AGP, 778-603-11AGP
802	Gauge for 720, 728 Series
802ST	Gauge for 720-11AST, 728-609-11AST
804N	Gauge for 703, 705, 731, 732, 740, 788 Series
805	Gauge for 750 Series
808N	Gauge for 760, 768, 769, 6005 Series
809N	Gauge for 770, 775, 780, 785, 790 Series
809SPU	Gauge for SPU Series
8002	Gauge for 7002 e-sphyg™ Series



800

802

804N



808N

809N

809SPU



8002

805

Inflation Bulbs

- For use with most aneroid or mercurial BP instruments
- End valve included
- Individually packaged
- One-year warranty on standard, three-year warranty on premium Adflow™ models



870N

873N

Ordering Information

Item	Description
873N	Standard Bulb with Regular End Valve
870N*	Adflow™ Bulb with Filter-Screen End Valve
870LN	Large Adflow™ Bulb with Filter-Screen End Valve (not shown)
804N-109	Bulb for 804N Palm Aneroid Only (not shown)

* Indicate GP for Gold-plated (870NGP) or ST for Tactical (870NST)

Deflation Valves

- Available in standard and premium Adflow™ models
- For use with most aneroid and mercurial BP instruments
- One-year warranty on standard, three-year on Adflow™

Ordering Information

Item	Description
871*	Adflow™ Deluxe Valve
874	Standard Valve

* Indicate GP for Gold-plated (871GP) or ST for Tactical (871ST)



874

871

Bulb & Valve Combinations

- For use with most aneroid or mercurial BP instruments
- End valve included
- Individually packaged (875PLF-10 is packaged in sets of 10)
- One-year warranty on standard, three-year on Adflow™

Ordering Information

Item	Description
872N*	Adflow™ Bulb & Valve (870N, 871)
872LN	Adflow™ Bulb & Valve, Large (870LN & 871)
875N	Standard Bulb & Valve (873N & 874)
878	Bulb & Auto Valve Assembly for 6005, 6012N
875PLF-10	Standard Bulb & Plastic Valve (10 Pack)

* Indicate GP for Gold-plated (872NGP) or ST for Tactical (872NST)

Adcuff™ Cuffs and Bladders 1 Tube / 2 Tube

- Durable nylon construction
- Exclusive Size Guide™ marking system
- 1-tube inflation bladder with 50cm tubing length (25cm on 2-tube)
- For use with most palm, traditional pocket, clock, or mercury aneroid instruments
- Adult size available in 17 color options
- Individually packaged
- Three-year warranty
- Connectors not included

Ordering Information

1 Tube Ordering Information					
Infant	Child	Sm. Adult	Adult	Lg. Adult	Thigh
845-7BK-1	845-9CBK-1	845-10SABK-1	845-11ABK-1	845-12XBK-1	
845-7IN-1	845-9CN-1	845-10SAN-1	845-11AN-1	845-12XN-1	845-13TN-1
845-7IOR-1	845-9COR-1	845-10SAOR-1	845-11AOR-1	845-12XOR-1	845-13TOR-1
845-7IOR-1	845-9CGR-1	845-10SARB-1	845-11AN-1	845-12XBD-1	845-13TBR-1

2 Tube Ordering Information					
Infant	Child	Sm. Adult	Adult	Lg. Adult	Thigh
845-7BK-2	845-9CBK-2	845-10SABK-2	845-11ABK-2	845-12XBK-2	
845-7IN-2	845-9CN-2	845-10SAN-2	845-11AN-2	845-12XN-2	845-13TN-2
845-7IOR-2	845-9COR-2	845-10SAOR-2	845-11AOR-2	845-12XOR-2	845-13TOR-2
845-7IOR-2	845-9CGR-2	845-10SARB-2	845-11AN-2	845-12XBD-2	845-13TBR-2

Additional Adult Cuff Color Options



NOTE: To ensure correct cuff color when ordering, add color suffix to model number (e.g., 845-11ARB-2)



845-1 Series



845-2 Series



Available in the colors and sizes below.
Also available as an option with select Diagnostix sphygs.

Ordering Information

1 Tube Ordering Information					
Infant	Child	Sm. Adult	Adult	Lg. Adult	Thigh
8451-7IOR-1	8451-9CGR-1	8451-10SARB-1	8451-11AN-1	8451-12XBD-1	8451-13TBR-1

2 Tube Ordering Information					
Infant	Child	Sm. Adult	Adult	Lg. Adult	Thigh
8451-7IOR-2	8451-9CGR-2	8451-10SARB-2	8451-11AN-2	8451-12XBD-2	8451-13TBR-2

Adcuff+ Cuffs

Our all-new line of one-piece, reusable blood pressure cuffs is designed for measurement accuracy, patient comfort, and practitioner ease.

- Bladderless design is simple to use and easy to clean
- Our most comprehensive Size Guide marking system features three different indicators (color coding, size icons, and cm range) for rapid identification of correct cuff size
- Convertible design for use with single- or double-tube systems
- Hook-and-loop adhesive rated for tens of thousands of cycles
- Gauge hang tab (on most sizes) compatible with conventional pocket aneroids
- Surface mounted tube ports permit a more uniform fit around patient limb
- Not made with natural rubber latex or phthalates
- Three-year warranty

Adcuff+ Inflation Systems

- Includes ADC's exclusive Adcuff+ one-piece bladderless nylon cuff featuring the Size Guide™ marking system
- One 50cm tube and one 25cm tube
- Adflow™ bulb and valve (872N) with filter-screen protection
- For use with most aneroid or mercurial blood pressure instruments
- Available in six sizes
- Individually packaged
- Three-year warranty
- Bayonet connector (8974M) included



Inflation System Ordering Information

Infant	Child	Sm. Adult
8651-7IOR	8651-9CGR	8651-10SARB
Adult	Lg. Adult	Thigh
651-11AN	8651-12XBD	8651-13TBR

Adcuff™ Inflation Systems

- Includes ADC's exclusive Adcuff™ nylon cuff (830 series) featuring the Size Guide™ marking system
- One 50cm tube and one 25cm tube
- Adflow™ bulb and valve (872N) with filter-screen protection
- For use with most aneroid or mercurial blood pressure instruments
- Available in six sizes
- Adult size available in 17 color options
- Individually packaged
- Three-year warranty
- Bayonet connector (8974M) included



Ordering Information

Infant	Child	Sm. Adult	Adult	Lg. Adult	Thigh
865-7IBK	865-9CBK	865-10SABK	865-11ABK	865-12XBK	865-13TBK
865-7IN	865-9CN	865-10SAN	865-11AN	865-12XN	865-13TN
865-7IOR	865-9COR	865-10SAOR	865-11AOR	865-12XOR	865-13TOR
865-7IOR	865-9CGR	865-10SARB	865-11AN	865-12XBD	865-13TBR

Additional Adult Cuff Color Options

V	BK	BD	DG	G	GR	M	N	OR	R	RB	TL
AD	PBS	PP	BCA	MT	NOTE: To ensure correct cuff color when ordering, add color suffix to model number (e.g., 865-11ARB)						

Specialty Cuffs and Bladders

- Choose from economical gray cotton, navy nylon D-Bar, or navy nylon D-Bar with attached chestpiece
- Inflation bladder with one 50cm tube and one 25cm tube
- Available in up to three sizes
- Individually packaged

Ordering Information

	Sm. Adult	Adult	Lg. Adult
845-770 Series	N/A	845-770-11AG-2	N/A
845-780 Series	845-780-10SAN-2	845-780-11AN-2	845-780-12XN-2
845-790 Series	845-790-10SAN-2	845-790-11AN-2	845-790-12XN-2

Please see page 41 for Advantage Digital home blood pressure replacement cuffs.





Adapters



Our new adapters provide a simple method of standardizing cuff purchases across your entire institution. Just identify the type of connector currently on your monitor and match it to our one-tube or two-tube adapter solution. Common configurations are shown below; custom options are also available.

For 1-Tube Monitors



With a Male Marquette Connector

1-Tube Cuff		HPF-S-MQF Bayonet (HP) Female to Marquette Female
2-Tube Cuff		SCF2-Y-MQF Screw (Dinamap) Female to Marquette Female

With a Female Screw (Dinamap) Connector

1-Tube Cuff		HPF-S-SCM Bayonet (HP) Female to Screw (Dinamap) Male
2-Tube Cuff		SCF2-Y-HPM Screw (Dinamap) Female to Bayonet (HP) Male

With a Different Type of Connector

1-Tube Cuff		HPF-S-N Bayonet (HP) Female to customizable open end
2-Tube Cuff		SCF2-Y-N Screw (Dinamap) Female to customizable open end

For 2-Tube Monitors

With Male Marquette Connectors

2-Tube Cuff		SCF-S2-MQF Screw (Dinamap) Female to Marquette Female
--------------------	---	---

With Female Bayonet (HP) Connectors

2-Tube Cuff		SCF-S2-HPM Screw (Dinamap) Female to Bayonet (HP) Male
--------------------	---	--

With a Different Type of Connector

2-Tube Cuff		SCF-S2-N Screw (Dinamap) Female to customizable open end
--------------------	---	--



Connectors

- Permit quick connection of various inflation systems or components
- Available in a variety of configurations and materials

Tube-to-Tube Connectors

	Item No.	Qty	Use With	Description
	611-20	1	Y Test Kit: Teaching Scopes 613, 661, 671	Y Connector
	611-20-10	10		
	920-011N	1	Connects two tubes	Double Male Metal Connector
	920-011	1	Connects two tubes	Double Male Plastic Connector
	920-011-10	10		

BP Connectors

	Item No.	Qty	Use with	Description
	8002-2	1	e-sphyg™	Plastic Locking Luer Connector
	9002-2	1	e-sphyg™ II	Plastic Connector
	8972-10	10	Universal Monitor Connector (fits most monitors)	Male Luer Slip Connector
	8973-10	10	Datascope	Female Locking Luer Connector
	8975-10	10	Neonatal SPU Cuffs	Neonatal Luer Slip Connector
	891	1 Set	ADC Clock Aneroids, Mercury Sphygs, Inflation Systems	Metal Luer Connector Set, 1 Male, 1 Female
	891F-10	10	Legacy Products	Metal Female Luer
	891M-10	10	Legacy Products	Metal Male Luer
	8971-10	10	Dinamap, WA Atlas and Vital Signs Monitors, Spot, Critikon Cuffs	Plastic Male Screw Adapter
	8971F-10	10	Dinamap, WA Atlas and Vital Signs Monitors, Spot, Critikon Cuffs	Plastic Female Screw Adapter
	8974-10	10	ADC Clock Aneroids, Mercury Sphygs, Inflation Systems	Plastic Male Bayonet Connector
	8974M-10	10	Adviview™ 2, HP/Phillips, Siemens, Spacelabs, IVAC/Alaris 4415, Criticare, Datascope Accutorr Plus, Passport 2 Monitors, 804N Palm Aneroid	Metal Male Bayonet Connector
	8974F-10	10	Adviview™ 2, HP/Phillips, Siemens, Spacelabs, IVAC/Alaris 4415, Criticare, Datascope Accutorr Plus, Passport 2 Monitors	Metal Female Bayonet Connector
	804C3	1	ADC Clock Aneroids, Mercury Sphygs, Inflation Systems 804N Palm Aneroid	Metal Female Bayonet Connector
	9000QCF-10	10	Adviview™, GE, Welch Allyn, Marquette	Female Quick Connector
	9000QCM-10	10	Adviview™, GE, Welch Allyn, Marquette	Male Quick Connector



952-025

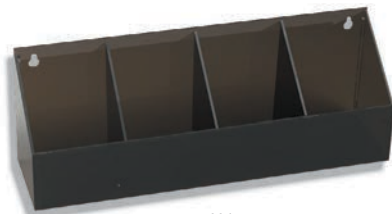

884

Sphyg Stand & Cuff Container

- Wall-mounted cuff storage containers
- Basket is vinyl-coated wire with extra room for large inflation systems
- Stand is a plexiglass container with four compartments. Measures 14" long, 3¼" deep. Countertop or wall mount
- All mounting hardware included

Ordering Information

Item	Description
952-025	Cuff Storage Basket for 750W, Adstation™
884	Sphygmomanometer Stand



Coiled Tubing

- Coiled TPU tubing to facilitate blood pressure measurement when using wall or mobile instruments
- Available in four-foot or eight-foot lengths (when extended)
- For use with all major brands of BP instruments
- Individually packaged
- Bayonet connector (8974F) included
- Bayonet connector (8974M) not included
- Three-year warranty

Ordering Information

Item	Description
885N	Coiled Tubing, 8-foot length
886N	Coiled Tubing, 4-foot length



885N



886N

Gauge Guards

- ADC gauge guards are available in bright orange for added visibility or traditional black
- Weighs 4 oz (113.3 g)

Ordering Information

Item	Description	Color Choices
899*	Gauge Guard Manometer Cover	BK O

NOTE: To ensure correct color when ordering, add color suffix to model number (e.g., 899BK)



899O



899BK

Test Kit

- Y tubing with inflation bulb, valve, and various connectors permit testing of accuracy for aneroids or mercury sphygs against unit of known accuracy

Ordering Information

Item	Description
991	Y Test Kit with Bulb, Valve and Connectors



Mercury Spill Kit

- Intended for all models of mercurial blood pressure devices when there is a mercury spill
- Includes 1 oz (28.3 g) pouch Green-Z absorbent; one scoop with attached scraper; 17"x10" white, self-sealing polybag; two tear-resistant, clear polybags; one pair Nitrile high-risk exam gloves (contains no latex); one safety shield combo mask; one "Caution Contains Mercury" sticker; and two heavy-duty twist ties

Ordering Information

Item	Description
980SK	Mercury Spill Kit



Repair Parts

The most commonly ordered miscellaneous repair and replacement parts for use with ADC brand products only (unless otherwise noted).

Gauge Crystals

- Clear plastic lens
- Threaded ring holds gauge crystal in place
- ADC gauges only

Ordering Information

Item	Description
893	Gauge Crystal for Pocket Gauges
895	Retaining Ring for 893 Crystal
896N	Gauge Crystal for 805 Gauge



End Valves Only

- For use with ADC and most brands of bulbs

Ordering Information

Item	Description
873-1	Standard End Valve
870-1	Adflow™ Filter -Screen End Valve
870-1GP	Adflow™ Filter-Screen End Valve, Gold-Plated
870-1ST	Adflow™ Filter -Screen End Valve, Tactical



Spring/Clip/Pin Assembly

- Permits pocket aneroid to be attached to cuff hang tab
- ADC gauges only

Ordering Information

Item	Description
898	Spring/Clip/Pin Assembly for Pocket Gauges





ADC builds more stethoscopes than any other U.S. firm.

Proscopes™ are ideal for general assessment and blood pressure measurement. Primarily for institutional use, these are available in more than half dozen models in hundreds of model options.

Our premium **Adscope®** brand meets the needs of today's demanding healthcare professional. Available in more than 12 models, including Cardiology, Clinician, and Sprague styles, we have the right scope for every application— at pricing that's as much as 40% less than other brands.

ADC scopes and components are contract manufactured exclusively for ADC by some of the world's leading ISO-certified subcontractors. **Proscope** and **Sprague** stethoscopes are manufactured in our own facility in Suzhou, China. **Adscope Clinician and Cardiology** components are contract manufactured in Taiwan.

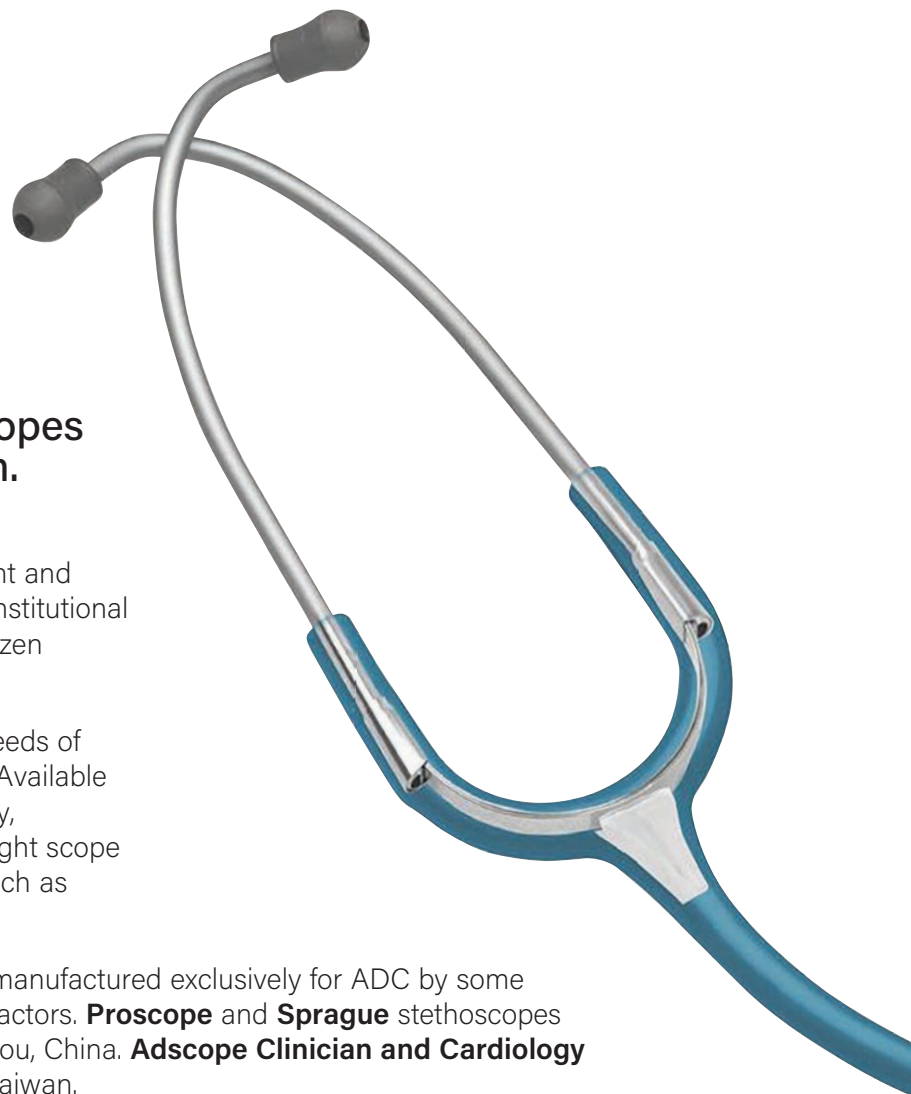

All ADC stethoscopes are subjected to a variety of proprietary tests to ensure they meet our demanding standards and our customers' expectations. Dimensional tests ensure that each component is machined and molded to spec. A torque tester ensures that models equipped with adjustable binaurals and dual-head chestpieces perform consistently, lot after lot.

Our custom-made, acoustic-test machine ensures that each model performs to spec. Acoustic transfer is tested on a random sample from each production lot – whether it's a \$3 disposable stethoscope or a \$200 cardiology model.

Adscope Clinician and Cardiology are inspected, assembled and 100% individually acoustically tested in New York.

adscope® Cardiology & Clinician

We offer two types of internal spring binaural/tubing assemblies on our premium Adscopes. Both feature the headset fixed at 15° forward for an anatomically correct fit and improved acoustic seal. Cardiology models feature a bi-lumen design for improved stereo separation of the channels. Clinician models feature a single lumen with reinforcing yoke for great sound and improved durability.

Aural tubes are machined from either lightweight aluminum alloy or special stainless steel that's up to 30% lighter, offering improved ergonomics and comfort. The concealed tensioning spring is tested up to 100,000 cycles to ensure a lifetime of use.



Adscope chestpieces are CNC machined to precise tolerances from premium metals like aluminum alloy or surgical stainless steel – all to provide remarkably consistent acoustic transfer performance, lot after lot. Combination models also feature an acoustically precise valve stem to eliminate acoustic leakage.



Adsoft™ Plus snap-on silicone eartips provide the ultimate in wearer comfort and acoustic seal.

And every Adscope Clinician and Cardiology is individually acoustic tested in our New York quality lab.



Hear enhanced high- and low-frequency body sounds with **Adjustable Frequency Design (AFD) diaphragms**

Our proprietary gasketed diaphragms work with the chestpiece to focus specific body sounds, simply by altering pressure. Use light pressure for lower, bell-type frequencies and firm pressure for enhanced higher, diaphragm-type frequencies.

ADC stethoscopes are offered in hundreds of colors and finish combinations. Options are shown on each model page and on our web site at www.adctoday.com/colorchart.

Tubing Colors: Standard Brush Finish



adscope^{LE}

Adscope LE is our collection of specially curated, limited-edition printed stethoscopes. Prints are offered in three clinician models: 603, 608, and 615. Some styles are also available with a Rose Gold or Tactical finish.

learn more: www.adctoday.com/AdscopeLE

Sprague stethoscopes are manufactured in our own facility in Suzhou, China.



adscope® S P R A G U E

Although the Sprague scope is an industry standard offered by a number of importers, only ADC's Adscope® Sprague offers a unique combination of patented and proprietary features that distinguish it from the competition.



Our patented valve mechanism virtually eliminates acoustic leakage. Our gasketed chestpiece drum does double duty improving both chestpiece acoustic seal and the security of the various chestpiece fittings.



Finally, our unique chestpiece "key" allows the diaphragms to be more easily serviced. Each Sprague is inspected prior to packaging in our New York facility. Every single one.

proscope™ General Exam STETHOSCOPE

Proscope stethoscopes are manufactured in our own facility in Suzhou, China. Binaurals for our Proscope styles – Bowles type, diaphragm only, dual head, pediatric, and infant – are machined from lightweight aluminum tube stock then anodized for a durable finish.



Y tubing is custom dip-molded to our specs in 16 colors. By maintaining a tight tolerance on tubing weight, we ensure consistent appearance and performance, lot after lot, year after year.



Our nurse-style, diaphragm-only and combination dual-head chestpieces use a proprietary snap-on rim and PVC-contoured diaphragm for acoustic performance up to 50% better than competing brands.

And we have the independent lab tests to prove it!

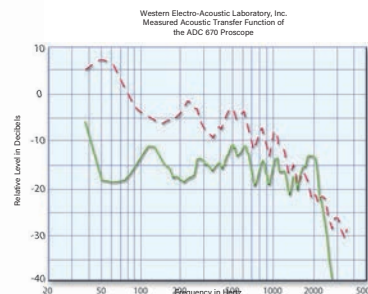

Cardiology Stethoscopes



Adscope cardiology stethoscopes stand head-to-head with the best. We offer four models: A platinum design featuring a diaphragm-only chestpiece with AFD Technology and convertible, traditional, and lightweight combination diaphragm and bell designs.

Headset Construction

Adsoft Plus snap-on silicone eartips (small and large) for exceptional comfort and fit

Large-bore stainless-steel* binaurals fixed at a 15° angle to ensure tight acoustic seal

Bi-lumen (dual-channel) construction optimizes acoustic pathway

PVC tubing made without latex or phthalates and stays soft and flexible



Lifetime warranty and free parts forever



Assembled, inspected, and packaged in the U.S.A.



Individually acoustic tested in New York
See page 52



AFD Technology on models 600, 601, and 606
See page 52



600

Model

Page 55



601

Page 56



602

Page 57



606

Page 58

Model	600	601	602	606
Performance	10	10	9.5	9.5
Key Features	Superior Acoustics AFD Diaphragm Ergonomic Chestpiece	Superior Acoustics AFD Diaphragm Convertible Chestpiece	Superior Acoustics	Lightweight Ergonomic AFD Diaphragm
Chestpiece	AFD Technology	AFD Technology	Diaphragm / Bell	AFD Diaphragm / Bell
Chestpiece/Aural Tube Material	Stainless*	Stainless*	Stainless	Aluminum
Length	27"	28"	28"	28"
Weight	7.2 oz	7.6 oz / 8.6 oz	7.2 oz	4.5 oz
Diaphragm Dia.	1 3/4"	1 3/4" & 1 1/8"	1 3/4"	1 3/4"
Bell Diameter	N/A	1 1/4"	1 1/4"	1 1/4"
Tubing Colors	9	9	4	8
Optional Finishes	Gold-Plated, Iridescent, Tactical	Iridescent, Mirror, Rose Gold, Tactical	N/A	Rose Gold, Tactical
ID Tag	Yes	Yes	Yes	Yes
Warranty	Lifetime	Lifetime	Lifetime	Lifetime

*Some special finishes have aluminum binaurals.



Tubing Colors: Standard Mirror Finish



Special Finishes



Ordering Information

Item	Description
600**	Adscope® 600, Cardiology, (Specify Color)

NOTE: To ensure correct color when ordering, add color suffix to model number (e.g., 600DG)



Adscope® 600 Platinum Cardiology

Superior acoustic performance with sculpted, single-sided chestpiece.

Overall Length: 27"
Standard Weight: 7.2 oz (203 g)*

PLATINUM-STYLE CHESTPIECE

- Sculpted, one-sided chestpiece for everyday convenience
- AFD diaphragm technology for the acoustic response of a traditional bell and diaphragm; use light pressure for low, bell-type frequency or firm pressure for high, diaphragm-type frequency
- CNC machined to exacting tolerances from surgical stainless steel for performance, durability, and comfort
- Lifetime warranty and free parts forever

CARDIOLOGY HEADSET

- Large-bore stainless-steel binaurals* fixed at a 15° angle to maximize comfort and acoustic seal
- Bi-lumen (dual channel) construction optimizes acoustic pathway
- PVC tubing is made without latex or phthalates and stays soft and flexible
- Adsoft™ Plus snap-on silicone eartips (includes both small and large) for exceptional comfort and fit

ALSO INCLUDES

- Non-chill diaphragm retaining rim for patient comfort
- Accessory kit with additional eartips and scope ID tag

THE ADC ADVANTAGE

- Assembled, inspected, and packaged in the USA
- Individually acoustic tested in the USA
- Lifetime warranty and free parts forever

* Weight may vary depending on finish. Some special finishes have aluminum binaurals.





Adscope® 601 Convertible Cardiology

Superior acoustic performance plus versatile, convertible bell and pediatric diaphragm.

Overall Length: 28"
Standard Weight: 7.6 oz (215 g)*

CONVERTIBLE CHESTPIECE

- Convertible chestpiece offers adult diaphragm and bell or adult and pediatric diaphragm configurations
- AFD technology for both adult and pediatric diaphragms; use light pressure for low, bell-type frequency or firm pressure for high, diaphragm-type frequency
- Extra-deep bell for unsurpassed low-frequency response
- CNC machined to exacting tolerances from surgical stainless steel for performance, durability, and comfort

CARDIOLOGY HEADSET

- Large-bore stainless-steel binaurals* fixed at a 15° angle to maximize comfort and acoustic seal
- Bi-lumen (dual channel) construction optimizes acoustic pathway
- PVC tubing is made without latex or phthalates and stays soft and flexible
- Adsoft™ Plus snap-on silicone eartips (includes both small and large) for exceptional comfort and fit

ALSO INCLUDES

- Non-chill diaphragm retaining rim for patient comfort
- Accessory kit with additional eartips and scope ID tag

THE ADC ADVANTAGE

- Assembled, inspected, and packaged in the USA
- Individually acoustic tested in the USA
- Lifetime warranty and free parts forever

*Weight with pediatric diaphragm is 8.6 oz (243 g). Weight may vary depending on finish. Some special finishes have aluminum binaurals.

Tubing Colors: Standard Brushed Finish



Tubing Colors: Mirror Finish



Additional Finishes



Ordering Information

Item	Description
601**	Adscope® 601, Cardiology Scope (Specify Color)

NOTE: To ensure correct color when ordering, add color suffix to model number (e.g., 601DG)





Accessory kit with spare diaphragm and eartips.

Adscope® 602 Traditional Cardiology

Superior acoustic performance with a traditional diaphragm and bell design.

Overall Length: 28"
Standard Weight: 7.2 oz (205 g)

COMBINATION CHESTPIECE

- Ultra-sensitive adult diaphragm for greater amplification and crisper high-frequency transmission
- Extra-deep bell for unsurpassed low-frequency response
- CNC machined to exacting tolerances from surgical stainless steel for performance, durability, and comfort

CARDIOLOGY HEADSET

- Large-bore stainless-steel binaurals fixed at a 15° angle to maximize comfort and acoustic seal
- Bi-lumen (dual channel) construction optimizes acoustic pathway
- PVC tubing is made without latex or phthalates and stays soft and flexible
- Adsoft™ Plus snap-on silicone eartips (includes both small and large) for exceptional comfort and fit

ALSO INCLUDES

- Non-chill diaphragm retaining rim for patient comfort
- Accessory kit with additional eartips and scope ID tag

THE ADC ADVANTAGE

- Assembled, inspected, and packaged in the USA
- Individually acoustic tested in the USA
- Lifetime warranty and free parts forever

Tubing Colors: Standard Brushed Finish

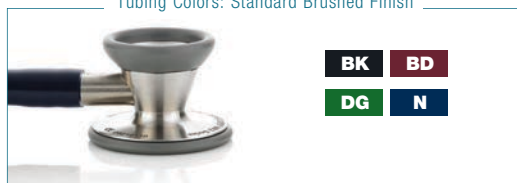

Ordering Information

Item	Description
602**	Adscope® 602, Cardiology Scope (Specify Color)

NOTE: To ensure correct color when ordering, add color suffix to model number (e.g., 602**BD**)





Adscope® 606 Ultra-Lite Cardiology

Cardiology performance at a fraction of the weight for all-day comfort.

Overall Length: 28"
Standard Weight: 4.5 oz (130 g)

LIGHTWEIGHT COMBINATION CHESTPIECE

- Ultra-sensitive adult diaphragm for greater amplification and crisper high-frequency transmission
- AFD diaphragm technology for tuneable acoustic response; use light pressure for low, bell-type frequency or firm pressure for high, diaphragm-type frequency
- Extra-deep bell for unsurpassed low-frequency response
- CNC machined to exacting tolerances from lightweight aluminum alloy

CARDIOLOGY HEADSET

- Large-bore aluminum binaurals fixed at a 15° angle to maximize comfort and acoustic seal
- Bi-lumen (dual channel) construction optimizes acoustic pathway
- PVC tubing is made without latex or phthalates and stays soft and flexible
- Adsoft™ Plus snap-on silicone eartips (includes both small and large) for exceptional comfort and fit

ALSO INCLUDES

- Non-chill diaphragm retaining rim for patient comfort
- Accessory kit with additional eartips and scope ID tag

THE ADC ADVANTAGE

- Assembled, inspected, and packaged in the USA
- Individually acoustic tested in the USA
- Lifetime warranty and free parts forever

Tubing Colors: Standard Satin Finish



Special Finishes



Ordering Information

Item	Description
606**	Adscope® 606, Ultra-Lite Scope (Specify Color)

NOTE: To ensure correct color when ordering, add color suffix to model number (e.g., 606**BD**)



Clinician Stethoscopes



Adscope clinician stethoscopes bring together the best in acoustic performance, all-day comfort, and incredible value. We offer five models: Two platinum designs featuring a diaphragm-only chestpiece with AFD Technology and three combination diaphragm and bell designs, convertible, traditional, and lightweight.

Headset Construction

Adsoft Plus snap-on silicone eartips (small and large) for exceptional comfort and fit

Stainless-steel* binaurals fixed at a 15° angle to ensure tight acoustic seal

Single lumen construction with reinforcing yoke molded into tubing



PVC tubing made without latex or phthalates and stays soft and flexible



Overall length: 30"



Lifetime warranty and free parts forever



Assembled, inspected, and packaged in the U.S.A.



Individually acoustic tested in New York
See page 52



AFD Technology
See page 52



615

Page 60



608

Page 61



612

Page 62



603

Page 63



619

Page 64

Model	615	608	612	603	619
Performance	9.5	9.5	9	9	8
Key Features	AFD Diaphragm Ergonomic Chestpiece	AFD Diaphragm Versatility	AFD Diaphragm Lightweight Ergonomic Chestpiece	AFD Diaphragm Combination Chestpiece	AFD Diaphragm Ultra Lightweight
Chestpiece	AFD Technology	Convertible AFD Technology	AFD Technology	Combination Diaphragm/Bell AFD Technology	Combination Diaphragm/Bell AFD Technology
Chestpiece/Aural Tube Material	Zinc / Stainless*	Stainless*	Zinc / Stainless	Stainless*	Aluminum
Weight	5.4 oz	5.8 oz	4.9 oz	5.8 oz	3.7 oz
Diaphragm Dia.	1½" Oval	1½"	1½"	1½"	1½"
Bell Diameter	N/A	1½"	N/A	1½"	1½"
Tubing Colors	25	24	5	25	19
AdscopeLE Print Colors	Yes	Yes	No	Yes	No
Optional Finishes	Tactical	Copper, Iridescent, Mirror, Rose Gold, Tactical	N/A	Copper, Gold-Plated, Iridescent, Rose Gold, Tactical	Champagne, Rose Gold, Smoke, Tactical

*Tactical, Iridescent, copper, and rose gold models have aluminum binaurals



Adscope® 615 Platinum Clinician

Exceptional acoustic performance with sculpted, single-sided chestpiece.

Overall Length: 30"
Standard Weight: 5.4 oz (152 g)*

PLATINUM-STYLE CHESTPIECE

- Sculpted, one-sided chestpiece with oversized, ovoid shape for enhanced acoustics
- AFD diaphragm technology for the acoustic response of a traditional bell and diaphragm; use light pressure for low, bell-type frequency or firm pressure for high, diaphragm-type frequency
- Machined from lightweight zinc alloy plated with an attractive satin stainless finish

CLINICIAN HEADSET

- Stainless-steel binaurals* fixed at a 15° angle to maximize comfort and acoustic seal
- Single lumen construction with reinforcing yoke molded into tubing
- PVC tubing is made without latex or phthalates and stays soft and flexible
- Adsoft™ Plus snap-on silicone eartips (includes both small and large) for exceptional comfort and fit

ALSO INCLUDES

- Non-chill diaphragm retaining rim for patient comfort
- Accessory kit with additional eartips and scope ID tag

THE ADC ADVANTAGE

- Assembled, inspected, and packaged in the USA
- Individually acoustic tested in the USA
- Lifetime warranty and free parts forever

* Weight may vary depending on finish. Tactical finish has aluminum binaurals.

Tubing Colors: Standard Brushed Finish

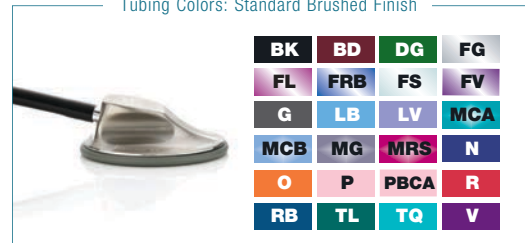

Special Finishes



Ordering Information

Item	Description
615**	Adscope® 615, Prof. Platinum Scope, (Specify Color)
615ST	Adscope® 615, Professional Platinum Scope, Tactical (Black Tubing Only)

NOTE: To ensure correct color when ordering, add color suffix to model number (e.g., 615DG)





See page 52

Tubing Colors: Standard Brushed Finish

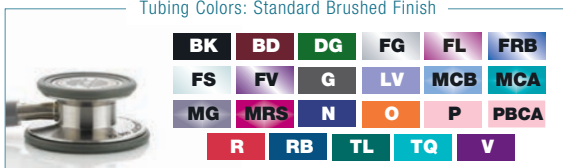

Tubing Colors: Mirror Finish



Tubing Colors: Iridescent Finish



Additional Finishes



Ordering Information

Item	Description
608**	Adscope® 608, Convertible Clinician Scope, (Specify Color)

NOTE: To ensure correct color when ordering, add color suffix to model number (e.g., 608DG)



Adscope® 608 Convertible Clinician

AFD technology and convertible design make this the most versatile of our clinician scopes.

Overall Length: 30"
Standard Weight: 5.8 oz (164 g)*

CONVERTIBLE CHESTPIECE

- Convertible chestpiece offers adult diaphragm and bell or adult and pediatric diaphragm configurations
- AFD technology for both adult and pediatric diaphragms; use light pressure for low, bell-type frequency or firm pressure for high, diaphragm-type frequency
- Extra-deep bell for unsurpassed low-frequency response
- Machined from surgical stainless steel* for outstanding performance and rugged durability

CLINICIAN HEADSET

- Stainless-steel binaurals* fixed at a 15° angle to maximize comfort and acoustic seal
- Single lumen construction with reinforcing yoke molded into tubing
- PVC tubing is made without latex or phthalates and stays soft and flexible
- Adsoft™ Plus snap-on silicone eartips (includes both small and large) for exceptional comfort and fit

ALSO INCLUDES

- Non-chill diaphragm retaining rim for patient comfort
- Accessory kit with additional eartips and scope ID tag

THE ADC ADVANTAGE

- Assembled, inspected, and packaged in the USA
- Individually acoustic tested in the USA
- Lifetime warranty and free parts forever

* Weight with pediatric diaphragm is 8.6 oz (243 g). Weight may vary depending on finish. Some special finishes have aluminum binaurals.





Adscope® 612 Platinum Lightweight Clinician

Exceptional lightweight performance with sculpted, single-sided chestpiece.

Overall Length: 30"
Standard Weight: 4.9 oz (139 g)

PLATINUM-STYLE CHESTPIECE

- Sculpted, one-sided chestpiece with oversized, ovoid shape for enhanced acoustics
- AFD diaphragm technology for the acoustic response of a traditional bell and diaphragm; use light pressure for low, bell-type frequency or firm pressure for high, diaphragm-type frequency
- Machined from lightweight zinc alloy plated with an attractive satin stainless finish

CLINICIAN HEADSET

- Stainless-steel binaurals fixed at a 15° angle to maximize comfort and acoustic seal
- Single lumen construction with reinforcing yoke molded into tubing
- PVC tubing is made without latex or phthalates and stays soft and flexible
- Adsoft™ Plus snap-on silicone eartips (includes both small and large) for exceptional comfort and fit

ALSO INCLUDES

- Non-chill diaphragm retaining rim for patient comfort
- Accessory kit with additional eartips and scope ID tag

THE ADC ADVANTAGE

- Assembled, inspected, and packaged in the USA
- Individually acoustic tested in the USA
- Lifetime warranty and free parts forever

Tubing Colors: Standard Brushed Finish

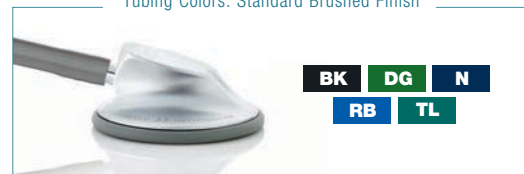

Ordering Information

Item	Description
612**	Platinum Edition Adscope-Lite® 612, Adult (Specify Color)

NOTE: To ensure correct color when ordering, add color suffix to model number (e.g., 612**TL**)





Tubing Colors: Standard Brushed Finish



Tubing Colors: Iridescent Finish



Additional Finishes



Ordering Information

Item	Description
603**	Adscope® 603, Adult, (Specify Color)

NOTE: To ensure correct color when ordering, add color suffix to model number (e.g., 603DG)



Adscope® 603 Clinician

Our most popular acoustic stethoscope with a traditional diaphragm and bell design.

Overall Length: 30"
Standard Weight: 5.8 oz (164 g)*

COMBINATION CHESTPIECE

- Adult diaphragm with tunable AFD technology; use light pressure for low, bell-type frequency or firm pressure for high, diaphragm-type frequency
- Extra-large bell for unsurpassed low-frequency response
- Machined from surgical stainless steel* for outstanding performance and rugged durability

CLINICIAN HEADSET

- Stainless-steel binaurals* fixed at a 15° angle to maximize comfort and acoustic seal
- Single lumen construction with reinforcing yoke molded into tubing
- PVC tubing is made without latex or phthalates and stays soft and flexible
- Adsoft™ Plus snap-on silicone eartips (includes both small and large) for exceptional comfort and fit

ALSO INCLUDES

- Non-chill diaphragm retaining rim for patient comfort
- Accessory kit with additional eartips and scope ID tag

THE ADC ADVANTAGE

- Assembled, inspected, and packaged in the USA
- Individually acoustic tested in the USA
- Lifetime warranty and free parts forever

* Weight may vary depending on finish. Some special finishes have aluminum binaurals.



Adscope® Lite 619 Clinician

Exceptional acoustic performance with lightweight diaphragm and bell design.

Overall Length: 30"
Standard Weight: 3.7 oz (105 g)*

COMBINATION CHESTPIECE

- Adult diaphragm with AFD technology for tunable acoustic response; use light pressure for low, bell-type frequency or firm pressure for high, diaphragm-type frequency
- Extra-large bell for low-frequency response
- Machined from lightweight aluminum for outstanding performance and lightweight comfort

CLINICIAN HEADSET

- Lightweight aluminum binaurals fixed at a 15° angle to maximize comfort and acoustic seal
- Single lumen construction with reinforcing yoke molded into tubing
- PVC tubing is made without latex or phthalates and stays soft and flexible
- Adsoft™ Plus snap-on silicone eartips (includes both small and large) for exceptional comfort and fit

ALSO INCLUDES

- Non-chill diaphragm retaining rim for patient comfort
- Accessory kit with additional eartips and scope ID tag

THE ADC ADVANTAGE

- Assembled, inspected, and packaged in the USA
- Individually acoustic tested in the USA
- Lifetime warranty and free parts forever

* Weight may vary depending on finish.



Ordering Information

Item	Description
619**	Adscope Lite® 619 Lightweight Scope, (Specify Color)

NOTE: To ensure correct color when ordering, add color suffix to model number (e.g., 619DG)



Pediatric Stethoscopes



ADC's pediatric Adscopes are designed for practitioners who work with the smallest patients. The instruments are scaled in size but offer a fully professional build quality, performance, and value. Choose from four different models, two with a traditional dual-head diaphragm and bell chestpiece and two with a single-sided chestpiece that combines the bell and diaphragm, virtually eliminating a primary source of acoustic leakage.



Lifetime warranty and free parts forever



Assembled, inspected, and packaged in the U.S.A.



Individually acoustic tested in New York
See page 52



AFD Technology
See page 52

Headset Construction

Adsoft Plus snap-on silicone eartips (small and large) for exceptional comfort and fit

Stainless-steel binaurals fixed at a 15° angle to ensure tight acoustic seal

Single lumen construction with reinforcing yoke molded into tubing



PVC tubing made without latex or phthalates and stays soft and flexible



614

Page 66



604

Page 67



605

Page 68



618

Page 69

Model	614	604	605	618
Performance	8.5	9.5	8.5	9
Key Features	AFD Diaphragm Ergonomic Chestpiece	AFD Diaphragm Pediatric Size	AFD Diaphragm Infant Size	AFD Diaphragm Patient Friendly
Chestpiece	AFD Technology Single Sided	AFD Technology Combination	Combination	AFD Technology Combination
Chestpiece/Aural Tube Material	Zinc / Stainless	Stainless	Stainless	Composite/Aluminum
Chestpiece Weight	1.4 oz	2.1 oz	2.1 oz	0.88 oz
Diaphragm Dia.	1"	1 1/8"	1 1/8"	1 1/2"
Bell Diameter	N/A	1 1/8"	7/8"	N/A
Total Length	29.5"	29.5"	29.5"	30"
Total Weight	4 oz	4.6 oz	4.1 oz	3 oz



Adscope® 614 Platinum Pediatric

Exceptional acoustic performance with single-sided pediatric chestpiece.

Overall Length: 29.5"
Standard Weight: 4.0 oz (116 g)

PLATINUM-STYLE CHESTPIECE

- Sculpted, one-sided chestpiece with 1-inch pediatric diameter
- AFD diaphragm technology for the acoustic response of a traditional bell and diaphragm; use light pressure for low, bell-type frequency or firm pressure for high, diaphragm-type frequency
- Machined from lightweight zinc alloy plated with an attractive mirror finish

CLINICIAN HEADSET

- Stainless-steel binaurals fixed at a 15° angle to maximize comfort and acoustic seal
- Single lumen construction with reinforcing yoke molded into tubing
- PVC tubing is made without latex or phthalates and stays soft and flexible
- Adsoft™ Plus snap-on silicone eartips (includes both small and large) for exceptional comfort and fit

ALSO INCLUDES

- Non-chill diaphragm retaining rim for patient comfort
- Accessory kit with additional eartips and scope ID tag

THE ADC ADVANTAGE

- Assembled, inspected, and packaged in the USA
- Individually acoustic tested in the USA
- Lifetime warranty and free parts forever

Tubing Colors: Standard Mirror Finish

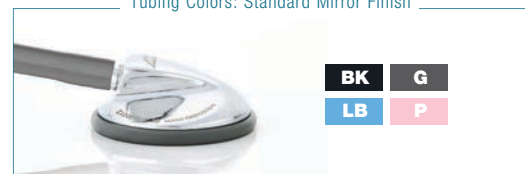

Ordering Information

Item	Description
614*	Adscope 614 Platinum Edition, Pediatric (Specify Color)

NOTE: To ensure correct color when ordering, add color suffix to model number (e.g., 614**LB**)





Adscope® 604 Pediatric

Legendary acoustics, performance, and functionality for pediatric care.

Overall Length: 29.5"

Standard Weight: 4.6 oz (131 g)

COMBINATION CHESTPIECE

- Pediatric diaphragm (1½" diameter) with tunable AFD technology; use light pressure for low, bell-type frequency or firm pressure for high, diaphragm-type frequency
- Large pediatric bell (1½" diameter) for enhanced low-frequency response
- Machined from surgical stainless steel* for outstanding performance and rugged durability

CLINICIAN HEADSET

- Stainless-steel binaurals fixed at a 15° angle to maximize comfort and acoustic seal
- Single lumen construction with reinforcing yoke molded into tubing
- PVC tubing is made without latex or phthalates and stays soft and flexible
- Adsoft™ Plus snap-on silicone eartips (includes both small and large) for exceptional comfort and fit

ALSO INCLUDES

- Non-chill diaphragm retaining rim for patient comfort
- Accessory kit with additional eartips and scope ID tag

THE ADC ADVANTAGE

- Assembled, inspected, and packaged in the USA
- Individually acoustic tested in the USA
- Lifetime warranty and free parts forever

Tubing Colors: Standard Brushed Finish

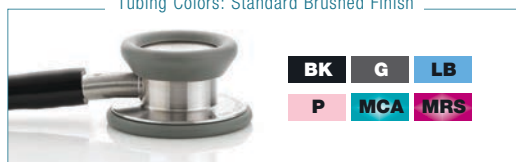

Ordering Information

Item	Description
604*	Adscope® 604 Pediatric Scope (Specify Color)

NOTE: To ensure correct color when ordering, add color suffix to model number (e.g., 604**P**)





Adscope® 605 Infant

Legendary acoustics, performance, and functionality for pediatric care.

Overall Length: 29.5"
Standard Weight: 4.1 oz (117 g)

COMBINATION CHESTPIECE

- Ultra-sensitive infant diaphragm (1 1/8" diameter) for greater amplification and crisper high-frequency transmission
- Infant bell (7/8" diameter) for unsurpassed low-frequency response
- Machined from surgical stainless steel for outstanding performance and rugged durability

CLINICIAN HEADSET

- Stainless-steel binaurals fixed at a 15° angle to maximize comfort and acoustic seal
- Single lumen construction with reinforcing yoke molded into tubing
- PVC tubing is made without latex or phthalates and stays soft and flexible
- Adsoft™ Plus snap-on silicone eartips (includes both small and large) for exceptional comfort and fit

ALSO INCLUDES

- Non-chill diaphragm retaining rim for patient comfort
- Accessory kit with additional eartips and scope ID tag

THE ADC ADVANTAGE

- Assembled, inspected, and packaged in the USA
- Individually acoustic tested in the USA
- Lifetime warranty and free parts forever

Tubing Colors: Standard Brushed Finish

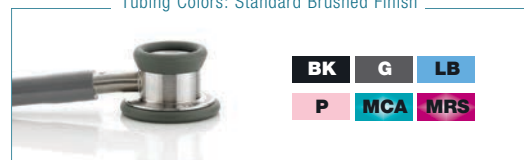

Ordering Information

Item	Description
605*	Adscope® 605 Infant Scope (Specify Color)

NOTE: To ensure correct color when ordering, add color suffix to model number (e.g., 605**G**)





See page 52



Tubing Colors



Ordering Information

Item	Description
618*	Adscope® 618 Adimals®, Pediatric (Specify Color)
618KIT	Adscope® 618 Adimals®, Replacement snap-on faces

NOTE: To ensure correct color when ordering, add color suffix to model number (e.g., 618**SF**)



Adscope® Adimals 618

Professional performance with styling kids love!

Overall Length: 30"
Standard Weight: 3.0 oz (85 g)



PEDIATRIC CHESTPIECE

- Molded-resin animal-face chestpiece optimally sized for pediatric patients (1½" diameter)
- AFD tuneable diaphragm technology; use light pressure for low, bell-type frequency or firm pressure for high, diaphragm-type frequency
- Seven interchangeable, snap-on animal faces: Bear, Deer, Frog, Koala, Monkey, Panda, and Tiger

CLINICIAN HEADSET

- Stainless-steel binaurals fixed at a 15° angle to maximize comfort and acoustic seal
- Single lumen construction with reinforcing yoke molded into tubing
- PVC tubing is made without latex or phthalates and stays soft and flexible
- Adsoft™ Plus snap-on silicone eartips (includes both small and large) for exceptional comfort and fit

ALSO INCLUDES

- Non-chill diaphragm retaining rim for patient comfort
- Accessory kit with additional eartips and scope ID tag

THE ADC ADVANTAGE

- Assembled, inspected, and packaged in the USA
- Individually acoustic tested in the USA
- Lifetime warranty and free parts forever

Adscope® Sprague Stethoscopes



Sprague stethoscopes are manufactured in our own facility in Suzhou, China.

The legendary design features of the Sprague have made it one of the most popular stethoscopes in history. It offers the perfect blend of acoustic sensitivity and professional versatility and has been an EMS and nursing favorite for years.

ADC's Adscope Sprague incorporates features found on no other model on the market, like a proprietary, patented valve mechanism that virtually eliminates acoustic leakage. The result is a Sprague that outperforms and outlasts the competition.

Traditional 2-Tube and Lightweight Single-Tube Designs



30" Tubing length



31.5" Tubing length

Also Available:
Our Proscope™ brand Sprague with a traditional 24" length



Pediatric Diaphragm/
Pediatric Bell



Pediatric Diaphragm/
Child Bell



Adult Diaphragm/
Pediatric Bell



Adult Diaphragm/
Adult Bell



Also available in our Pro's Combo kits!
See pages 25, 28, and 29 for options.



Adscope® 641 Sprague Scope

Why own just a Sprague stethoscope when you can own an Adscope® Sprague?

Overall Length: 30"
Standard Weight: 7.0 oz (198 g)

PEDIATRIC CHESTPIECE

- Threaded chestpiece drum made from chrome-plated zinc
- Five interchangeable chestpiece fittings: adult diaphragm, pediatric diaphragm, and three bells (1¼", 1", ¾") for complete diagnostic capability on most patients
- Proprietary valve mechanism eliminates acoustic leakage
- Double-tube configuration with adjustable aluminum binaurals
- Now built with Adsoft Plus snap-on silicone eartips (large size) for exceptional comfort and fit
- Complete with an accessory pouch containing the bell chestpieces, chestpiece key, two spare diaphragms, and additional pair of Adsoft Plus eartips (small size)
- Five-year warranty
- Inspected and packaged in the U.S.A.



Pediatric Configuration

Chestpiece Key

Tubing Colors

BB	BK	BD	DG	FKW	FL
FM	FPB	FPL	GR	LB	LV
M	N	NB	NGR	NO	NP
NY	P	R	RB	TL	V

Ordering Information

Item	Description
641*	Adscope® 641 Sprague Scope (Specify Color)

NOTE: To ensure correct color when ordering, add color suffix to model number (e.g., 641DG)

NOTE: To ensure correct color when ordering, add color suffix to model number (e.g., 641DG)



Accessory kit containing bell chestpieces, chestpiece key, 2 spare diaphragms, and additional pair of small Adsoft Plus eartips.

Adscope® 645 Limited-Edition Sprague

Combining legendary acoustics with classic styling.

Overall Length: 30"

Standard Weight: 7.7 oz (218 g)

- Generous plating of metal surfaces with 5 microns of 18-karat gold, polished to a brilliant shine
- Classic Sprague-style scope with convertible chestpiece and five interchangeable chestpiece fittings for unsurpassed versatility
- Dual-tube design for improved stereo separation
- Proprietary valve mechanism eliminates acoustic leakage
- Now built with Adsoft Plus snap-on silicone eartips (large size) for exceptional comfort and fit
- Complete with an accessory pouch containing three bell chestpieces, chestpiece key, spare diaphragms, and one additional pair of Adsoft Plus eartips (small size)
- One-year warranty on finish; five-year warranty on performance

Ordering Information

Item	Description
645	Adscope® 645 Gold-Plated Sprague Scope (Black Tubing Only)



Adscope® 646ST Tactical Sprague

ADC's legendary Sprague with stealth black chrome for a striking appearance.

Overall Length: 30"

Standard Weight: 7.5 oz (212 g)

- Threaded zinc chestpiece drum with all-black tactical finish
- Five interchangeable chestpiece fittings: adult diaphragm, pediatric diaphragm, and three bells (1¼", 1", ¾") for complete diagnostic capability on most patients
- Proprietary valve mechanism eliminates acoustic leakage
- Double-tube configuration with adjustable aluminum binaurals in all-black tactical finish
- Now built with Adsoft Plus snap-on silicone eartips (large size) for exceptional comfort and fit
- Complete with an accessory pouch containing the bell chestpieces, chestpiece key, two spare diaphragms, and additional pair of Adsoft Plus eartips (small size)
- Inspected and packaged in the USA

Ordering Information

Item	Description
646ST	Adscope® 646ST Tactical Sprague (Black Tubing Only)



Adscope® 647 Sprague-1

ADC's legendary Sprague with a lightweight, single-tube design for greater comfort and convenience.

Overall Length: 31.5"

Standard Weight: 5.7 oz (198.4 g)

- Threaded chestpiece drum made from chrome-plated zinc
- Five interchangeable chestpiece fittings: adult diaphragm, pediatric diaphragm, and three bells (1¼", 1", ¾") for complete diagnostic capability on most patients
- Extra-thick "Y" tubing with adjustable aluminum binaurals
- Proprietary valve mechanism eliminates acoustic leakage
- Now built with Adsoft Plus snap-on silicone eartips (small size) for exceptional comfort and fit
- Complete with an accessory pouch containing the bell chestpieces, chestpiece key, two spare diaphragms, and additional pair of Adsoft Plus eartips (large size)
- Inspected and packaged in the USA

Ordering Information

Item	Description
647*	Adscope® 647 Sprague-1 (Specify Color)

Color Choices



NOTE: To ensure correct color when ordering, add color suffix to model number (e.g., 647**RB**)



Proscope™ 640BK Sprague

Our exclusive design with traditional 16" length.

Overall Length: 24"

Standard Weight: 7 oz (198.4 g)

- Traditional 16" double-tube configuration with adjustable aluminum binaurals
- Threaded aluminum chestpiece drum
- Five interchangeable chestpiece fittings: adult diaphragm, pediatric diaphragm, and three bells (1¼", 1", ¾") for complete diagnostic capability on most patients
- Proprietary valve mechanism eliminates acoustic leakage
- Now built with Adsoft Plus snap-on silicone eartips (large size) for exceptional comfort and fit
- Complete with an accessory pouch containing the bell chestpieces, chestpiece key, two spare diaphragms, and additional pair of Adsoft Plus eartips (small size)
- One-year warranty
- Inspected and packaged in the USA

Ordering Information

Item	Description
640BK	Proscope™ 640BK 16" Sprague (Black Tubing Only)



Institutional Proscopes



One-year warranty



Ultra-light weight



Not made with natural rubber latex



Inspected and packaged in the U.S.A.

ADC manufactures more institutional scopes than any other firm anywhere. Our proprietary design features differentiate these value-priced instruments from others on the market. You'll find benefits like longer binaurals for a more comfortable fit or diaphragm and rim designs that improve acoustic performance by up to 50%.

- Lightweight comfort with sensitive acoustics
- Adult, Pediatric, and Infant sizes
- Diaphragm-only and diaphragm/bell combination chestpieces
- Variety of colors and packaging options for departmental coding and hospital use
- Display packaging for retail sales
- Disposable models that are MRI compatible
- Made without phthalates or natural rubber latex



Proscope 662:

Bowles style with traditional raised stem design
(see page 77)



660 Nurse Scope, 670 Adult Dual Head, 675 Pediatric Dual Head, and 676 Infant Dual Head



Individually boxed and institutional packaging options available





670
Adult
Dualhead

675
Pediatric
Dualhead

676
Infant
Dualhead

660
Nurse
Scope

Proscopes™

Combining lightweight comfort with sensitive acoustics, ADC Proscopes™ are an ideal general-exam scope for the institutional setting.

The Proscope™ series features

- Choice of four models: diaphragm-only adult, combination diaphragm/bell adult, pediatric, and infant
- Proprietary diaphragm enhances acoustic response by up to 50% over competing designs
- Adjustable, lightweight extra-long aluminum binaurals with threaded PVC eartips
- Phthalate-free tubing in choice of 16 colors facilitates departmental coding
- Inspected and packaged in the USA
- One-year warranty

Ordering Information

Item	Description
660**	Proscope™ 660, Nurse Scope (Specify Color)
670**	Proscope™ 670, Dualhead Scope (Specify Color)
675**	Proscope™ 675, Pediatric Scope (Specify Color)
676**	Proscope™ 676, Infant Scope (Specify Color)

Color Choices

BK	BD	G	GD	LB
M	N	NO	NP	NY
P	R	RB	TL	V
	Y			

NOTE: To ensure correct color when ordering, add color suffix to model number (e.g., 660**BD**)



Proscope™ Model Descriptions

Specifications/Item	660	670	675	676
Patient Type	Adult	Adult	Pediatric	Infant
Chestpiece Type	Diaphragm Only	Diaphragm/Bell	Diaphragm/Bell	Diaphragm/Bell
Diaphragm Diameter	1 3/4"	1 3/4"	1 1/4"	3/4"
Bell Diameter	N/A	3/4"	3/4"	3/4"
Overall Weight	68 gr (2.4 oz)	85 gr (3 oz)	75 gr (2.6 oz)	75 gr (2.6 oz)
Overall Length	79 cm (31")	80 cm (31.5")	80 cm (31.5")	79 cm (31")



Proscope™ SPU

A single-patient-use version of our best-selling scopes, Proscope™ SPU provide an incredibly cost-effective solution for general auscultation needs.

Proscope™ SPU features

- Choice of four models: diaphragm-only adult, combination diaphragm/bell adult, pediatric, and infant
- Proprietary diaphragm enhances acoustic response by up to 50% over competing designs
- Adjustable lightweight aluminum binaurals with threaded PVC eartips
- Choice of up to five of the best-selling tubing colors
- Fully assembled, each in polybag, 10/carton, 5 cartons (50 scopes)/case
- Non-sterile
- Made in China

Proscope™ SPU Model Descriptions

Specifications/Item	660	670	675	676
Patient Type	Adult	Adult	Pediatric	Infant
Chestpiece Type	Diaphragm Only	Diaphragm/Bell	Diaphragm/Bell	Diaphragm/Bell
Diaphragm Diameter	1¾"	1¾"	1¾"	20mm
Bell Diameter	N/A	¾"	¾"	20mm
Overall Weight	68 gr (2.4 oz)	85 gr (3 oz)	75 gr (2.6 oz)	75 gr (2.6 oz)
Overall Length	80 cm (31.5")	84 cm (32")	80 cm (31.5")	79 cm (31")
Tubing Colors	5	5	Black Only	Black Only

Ordering Information

Item	Description
660**H	Proscope™ 660, Nurse Scope (Specify Color)
670**H	Proscope™ 670, Dualhead Scope (Specify Color)
675BKH	Proscope™ 675, Pediatric Scope (Black Only)
676BKH	Proscope™ 676, Infant Scope (Black Only)

Color Choices



NOTE: To ensure correct color when ordering, add color suffix to model number (e.g., 670RBH)



Proscope™ 662

Our traditional Bowles scope provides outstanding performance.

The 662 Bowles scope features

- Chrome-plated zinc diaphragm-only chestpiece (1.7") with traditional raised-stem design
- Phthalate-free black tubing only
- Weighs 2.7 oz (77 g)
- Overall length 31.5"

Ordering Information

Item	Description
662	Proscope™ 662 Bowles Scope (Black Tubing Only)



Proscope™ 665

An SPU scope with ABS construction throughout.

The 665 features

- Nurse-style, diaphragm-only single-patient-use scope
- ABS construction throughout is super lightweight
- May be ETO sterilized and safely incinerated
- Ultra-sensitive diaphragm for outstanding acoustic performance
- Individually packaged in a sealed polybag
- Weighs 1.5 oz (42.5 g) for comfort, yet is remarkably durable
- Overall length 32"
- 10 units/carton, 5 cartons (50 scopes)/case
- MRI safe
- Non-sterile
- Made in China

Ordering Information

Item	Description
665RB	Proscope™ 665, SPU 50/Cs, Royal Blue
665Y	Proscope™ 665, SPU 50/Cs, Yellow

Color Choices



Proscope™ 664

A hybrid SPU scope that combines an ABS chestpiece with a traditional headset.

The 664 features

- Diaphragm-only ABS chestpiece with non-chill rim for patient comfort
- 22" PVC Y-tubing
- Aluminum binaurals
- Weighs 2.5 oz (70.8 g), Overall length 32"
- Individually polybagged, 10/carton, 5 cartons (50 scopes)/case
- Non-sterile
- Made in China

Ordering Information

Item	Description
664*	Proscope™ 664, Disposable Scope (Specify Color)

Color Choices



NOTE: To ensure correct color when ordering, add color suffix to model number (e.g., 664Y)



Teaching Stethoscopes



An essential training aid that allows teachers and students to listen to heart and lung sounds simultaneously.

Teaching stethoscopes feature two headsets, allowing the student and the instructor to listen simultaneously. ADC offers options in both our premium Adscope® brand and our institutional Proscope™ series.



Our Adscope 613 Teaching Scope is built with the same stainless-steel components used to make our legendary 603 instrument. Headsets are color coded: black for the teacher and royal blue for the student.

We offer two styles of teaching scopes in our Proscope brand, a diaphragm-only model and a combination diaphragm/bell model. Both offer two sets of binaurals.



Model	Adscope® 613 Page 79	Proscope™ 661 Page 80	Proscope™ 671 Page 80
Key Features	Premium Build Color-Coded Headsets	Economical Build Single-Sided Chestpiece	Economical Build Dual-head Chestpiece
Chestpiece	AFD Technology Combination Diaphragm/Bell	AFD Technology Nurse Style	Combination Diaphragm/Bell
Chestpiece/Aural Tube Material	Stainless Steel	Aluminum	Aluminum
Total Weight	9.4 oz	5 oz	5.5 oz
Total Length	43"	44.5"	44.5"
Warranty	Lifetime	1 Year	1 Year



Double leaf spring with reinforcing yoke



Adscope® 613 Teaching Scope

A premium teaching scope built from Adscope® components.

Adscope® 613 teaching scope features

- Combination diaphragm/bell chestpiece precisely machined to exacting tolerances from surgical stainless steel for outstanding performance and rugged durability
- Extra-large bell (1 3/8" diameter) for unsurpassed low-frequency response
- Ultra-sensitive diaphragm (1 1/8" diameter) with adjustable frequency design (AFD) technology for greater amplification and crisper high-frequency response
- Non-chill bell and diaphragm retaining rims for patient comfort
- Two clinical headset, both with reinforcing yoke molded into the flexible 22" PVC tubing and stainless-steel binaurals fixed at 15° angle for greater comfort
- Adsoft™ Plus silicone eartips for the ultimate in wearing comfort and acoustic seal
- Includes accessory kit with extra Adsoft™ Plus snap-on silicone eartips and scope ID tag
- Weighs 9.4 oz (266.5 g)
- Overall length 43"
- Inspected, assembled, and packaged in the USA
- Individually acoustic tested in the USA
- Lifetime warranty and free parts forever

Ordering Information

Item	Description
613BKRB	Adscope® 613, Teaching Scope, R Blue/Black





Proscope™ Teaching Dualhead Scope

A training aid that allows student and instructor to listen simultaneously.

The Proscope™ Teaching Scope features

- Combination diaphragm/bell Proscope™ chestpiece
- Two sets of adjustable aluminum binaurals
- Two sets of flexible 22" and one straight 10" length of black phthalate-free tubing
- Weighs 5.5 oz (156 g)
- Overall length 44.5"
- Inspected and packaged in the USA
- One-year warranty

Ordering Information

Item	Description
671	Proscope™ 671, Teaching Dualhead Scope, Black



Proscope™ Teaching Nurse Scope

A training aid that allows nursing student and instructor to listen simultaneously.

The Proscope™ Teaching Scope features

- Diaphragm only (nurse type) Proscope™ chestpiece
- Two sets of adjustable aluminum binaurals
- Two sets of flexible 22" and one straight 10" length of black phthalate-free tubing
- Weighs 5 oz (142 g)
- Overall length 44.5"
- Inspected and packaged in the USA
- One-year warranty

Ordering Information

Item	Description
661	Proscope™ 661, Teaching Nurse Scope, Black



Stethoscope Accessories



Keep your stethoscope
secure and organized with
accessories from ADC

The ADC line includes a selection of practical, well-designed accessories that can be used with most stethoscopes on the market today.

- The MEDIC instrument case holds a stethoscope or adult sphygmomanometer while securing an assortment of everyday tools.
- Wearable stethoscope holders come in two styles: our original Scope Hip Clip, made from lightweight plastic, and our newer Nylon Scope Holster with hook-and-loop adhesive and wraparound form. Both clip to your belt, uniform, or scrubs.
- Rounding out the line are two styles of plastic scope ID tags and a reusable tape holder.



MEDIC instrument cases in two sizes, Large and Small



In-house laser engraving is available with our scope ID tag. Whether you're looking to personalize a single instrument or adding department or corporate branding for an institutional purchase, our New York based production team is here to help. Call for more details.



1028SBK
(Small)



1028LBK
(Large)



1028LBK
(Large)



1028SBK
(Small)

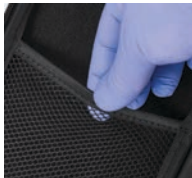

Ordering Information

Item	Description
1028LBK	MEDIC™ Carry Case, Large, Black
1028SBK	MEDIC™ Carry Case, Small, Black



MEDIC™ Instrument Case

The all-new MEDIC instrument case is built with a rigid exterior and inner divider panel that safely hold a stethoscope or adult sphyg while securing an assortment of everyday tools and accessories.

Available in two sizes, small and large.

1028 MEDIC Instrument Case

- Rigid, water-resistant shell made from EVC
- Three-section interior for better organization and instrument protection
- Divider with integrated elastic straps and small mesh pocket
- Large mesh compression pocket on inside cover
- Soft lining throughout main compartment
- Heavy-duty, self-repairing nylon zipper with two oversized soft-touch pulls and protection sleeve
- Removable wrist strap
- Large measures 12.75" x 5.75" x 2.5" and fits Adscope Cardiology models (and comparable instruments)
- Small measures 11" x 4.5" x 2.25" and fits Adscope Clinician models (and comparable instruments)
- One-year warranty

*Instruments shown in photos are not included.



Nylon Scope Holster

A secure way to carry your stethoscope.

The 217BK Scope Holster features

- Flexible, lightweight, 600D nylon with durable hook-and-loop adhesive
- Wraparound design for a snug and secure hold
- Keeps your hands free while reducing neck strain and chest tenderness
- Cleans easily
- One-year warranty



Ordering Information

Item	Description
217BK	Nylon Scope Holster, Black
217BKQ	Nylon Scope Holster, Black, Display Box



Scope Hip Clip

A simple alternative to carrying your stethoscope.

The 218 Hip Clip features

- Lightweight plastic design
- Easy waistband clip
- Reduces neck strain and chest tenderness
- Frees use of hands
- Cleans easily
- Available in four colors



Ordering Information

Item	Description
218*	Scope Hip Clip (Specify Color)

Color Choices



NOTE: To ensure correct color when ordering, add color suffix to model number (e.g., 218**RB**)



Scope and Sphyg ID Tags

Plastic ID tags that protect your diagnostic investment.

The 697 and 698 feature

- Durable polypropylene construction
- Locks onto the tubing of most ADC brand (and virtually any other brand) stethoscope.
- The 697BK can also be used on the tubing of blood pressure instruments
- Room for personalization
- Engravable version (697BKL) can be personalized with logo or text engraving

Ordering Information

Item	Description
697BK	Stethoscope ID Tag, Premium, Black
697BCA	Stethoscope ID Tag, Premium, Breast Cancer Pink
697BKL	Engravable Stethoscope ID Tag, Premium, Black
698BK	Scope/Sphyg ID Tag, Black

*The 697 is supplied with most Adscopes.

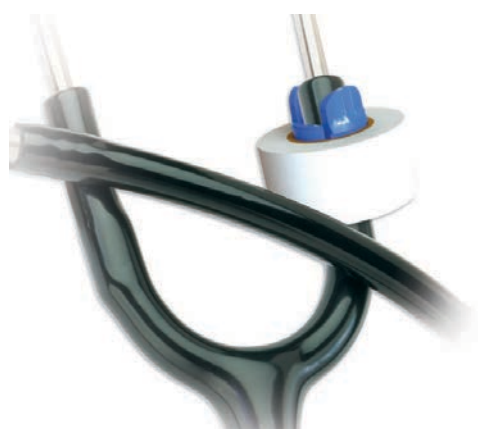

S.T.H.1

Reusable tape holder secures 1" medical tape to your stethoscope for easy, rapid access.

The 219 S.T.H.1 features

- Fits stethoscopes of all sizes
- Keeps medical tape close at hand
- Made of solid, lightweight material
- Choose from seven colors to match your scrubs, uniform, or shoes
- Made in the USA

Ordering Information

Item	Description
219*	Scope Tape Holder (Specify Color)

Color Choices

BK	NGR	P	R
RB	V	W	

NOTE: To ensure correct color when ordering, add color suffix to model number (e.g., 219**RB**)

Infrared Thermometers



All ADC infrared thermometers meet ASTM E1965-98 standards for accuracy.

ADC is one of the largest suppliers of thermometers to the professional medical channel. Our infrared thermometers use a lens system to focus infrared radiation onto a detector that converts the energy absorbed into an electrical signal. ADC offers five models of infrared thermometers, two tympanic and three non-contact.

All models feature:

- ✓ Infrared Technology
 - ✓ F/C Switchable, LED Display
 - ✓ Giftbox Packaging
 - ✓ Batteries included
- ✓ 2-Year Warranty
 - ✓ Audible Beep
 - ✓ Auto Off

Model



Page 86



Page 87



Page 87



Page 89



Page 89

Type	Non-Contact	Non-Contact	Non-Contact	Tympanic	Tympanic
Response Time	1 Second	1 Second	2 Seconds	1 Second	1 Second
Memory	30x	9x	50x	12x	Last-Reading
Needs Sheaths	No	No	No	No	Yes
Battery Type	2 - 1.5V (AAA)	Li-ion	2 - 1.5V (AAA)	CR2032	CR2032
Battery Life	2,000 uses	300,000 uses	2,000 uses	1,000 uses	1,000 uses
Dimensions	2.06" x 1.75" x 5" 52.4 x 44.5 x 129.9mm	5" x 1.2" x 1.6" 85 x 26 x 26mm	5.9" x 1.7" x 3.7" 150 x 44 x 95mm	5" x 1.2" x 1.6" 127 x 31 x 40mm	5.5" x 1" x 0.79" 139.7 x 26 x 20mm
Weight	3 oz (87 g)	1.6 oz (45 g)	4.6 oz (130.5 g)	1.9 oz (53 g)	1.6 oz (45 g)
Human Range	50°-122°F / 10°-50°C	71.6°-109.9°F / 22°-43.3°C	93.2°-109.4°F / 34°-43°C	32°-212°F / 0°-100°C	89.6°-108°F / 32°-42.2°C
Human Accuracy	±0.5°F / ±0.3°C	±0.4°F / 0.2°C	±0.5°F / 0.3°C	±0.2°F / 0.1°C	±0.4°F / 0.2°C
Object Range	32°-212°F / 0°-100°C	N/A	32°-212°F / 0°-100°C	32°-212°F / 0°-100°C	N/A
Object Accuracy	±1°F / ±1°C	N/A	±3.6°F / ±0.2°C	±0.2°F / ±0.1°C	N/A
Operating Environment	60.8°F-104°F 16°C-40°C	60.8°F-104°F 16°C-40°C	59°F-104°F 15°C-40°C	50°F-104°F 10°C-40°C	50°F-104°F 10°C-40°C
Storage Environment	-4°F-122°F -20°C-50°C	-4°F-131°F -20-55°C	-4°F-131°F -20-55°C	-13°F-131°F -25°C-55°C	-13°F-131°F -25°C-55°C



Measurement
Sensor Lens



Optional
Wall
Cradle



The Adtemp™ 429 offers 2 scan modes:

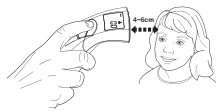

1. Human Mode

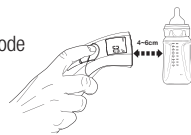

2. Object/Liquid Mode

Ordering Information

Item	Description
429	Adtemp™ 429, Non-Contact Thermometer
429CRADLE	Adtemp™ 429 Wall Cradle



This item is not available for sale in Canada



Adtemp™ 429 Non-Contact Thermometer

Easy-to-use infrared thermometer measures temperature instantly at the forehead! Convenient, non-contact measurement makes the Adtemp™ 429 the ideal instrument for use on all patients.

The Adtemp™ 429 infrared thermometer features

- One-second readings
- Large 6mm illuminated display
- °F/°C switchable display and switchable Human/Object modes
- Measuring range (Human)
50.0°F - 122.0°F +/- .5°F (10°C - 50°C +/- .3°C)
- Measuring range (Object)
32.0°F - 212.0°F +/- 1°F (0°C - 100°C +/- 1°C)
- 30-reading memory
- Audible beep when measurement complete (except Night mode)
- Night mode function mutes audibles for patient care
- Measures 5" (129.9 mm) long and weighs 3 oz (87g)
- Powered by two 1.55V AAA alkaline batteries (included)
- Optional wall cradle available



Adtemp™ Mini 432 Non-Contact Thermometer

The Adtemp™ Mini 432, is compact, lightweight, and incredibly portable. Clips to a retractable lanyard (included), making it the perfect instrument for patient rounds.

The Adtemp™ Mini 432 infrared thermometer features

- One-second readings
- Compact, lightweight size, measures 3.5" and 1.6 oz
- Color-coded LCD display with fever warning
- 9-reading memory
- °F/°C switchable display
- Rechargeable Li-ion battery, good for 1,000 measurements on a full charge, and 300,000 measurements over lifetime (micro USB cable included)
- Clips to wearable, retractable lanyard so it's always on hand
- Audible beep when measurement is complete



Ordering Information

Item	Description
432	Adtemp™ Mini 432, Non-Contact Thermometer

 This item is not available for sale in Canada





Measurement Sensor Lens



Adtemp™ 433 Non-Contact Thermometer

The Adtemp 433 features a trigger-style design and fast measurements. It's perfect for rapid screening in medical environments, offices, restaurants, and more.

The Adtemp™ 433 infrared thermometer features

- Accurate readings in less than two seconds
- Trigger-style design for rapid screenings at the forehead
- No skin contact required, minimizes the risk of cross contamination
- Color-coded LCD display with fever warning
- Dual mode, body and surface
- Audible beep when measurement is complete
- 50-reading memory
- °F/°C switchable display
- Uses 2 AAA batteries (included) with battery life of about 2,000 readings
- Measures 5.9" x 1.7" x 3.7" (150 mm x 95 mm x 44 mm), weighs 4.6 oz. (130.5 g) with batteries
- Meets ASTM E1965-98 standards for accuracy
- 2-year warranty

Ordering Information

Item	Description
433	Adtemp™ 433, Non-Contact Thermometer

This item is not available for sale in Canada



Adtemp™ 424 Infrared Ear Thermometer

Easy-to-use tympanic thermometer measures core temperature instantly. Convenient, economical probe covers make it the ideal instrument for use on all types of patients.

The Adtemp™ 424 Thermometer features

- One-second measurement using scan/peak technology
- Large 6mm illuminated display
- Temperature range from 89.6°F - 108°F +/- .4°F (32°C - 42.2°C +/- .2°C)
- °F/°C switchable display
- Fever indicator at 99.5°F (37.5°C)
- Last-reading memory
- Audible beep when measurement is complete
- Auto off conserves battery life
- Compact design: 5½" (13.97cm) long, weighs 1.6oz (45.3g) including battery
- Powered by 3V (CR2032) battery (included)
- Includes 20 probe covers in convenient dispenser
- Desktop storage caddy



Ordering Information

Item	Description
424	Adtemp™ 424 Infrared Ear Thermometer
425-40	Adtemp™ Tympanic Sheaths, 40/Pkg

 This item is not available for sale in Canada



Adtemp™ 421 Digital Ear Thermometer

The most compact tympanic thermometer on the market.

The Adtemp™ 421 thermometer features

- Measures core temperature instantly from the ear reliably and accurately
- Measuring range 32°F-212°F ±0.2°F (0°C-100°C ±0.1°C)
- Probe-cover-FREE design is less costly and more convenient to use
- Large 6mm illuminated display is easy to read
- Compact 5" long (12.7 cm), 1.9 oz (53.86g) ergonomic design fits comfortably in operator's hand and patient's ear
- Audible fever indicator at 99.5°F (37.5°C)
- 12-reading memory
- Complete with 3V (CR2032) battery, storage/travel case, and operating instructions

Ordering Information

Item	Description
421	Adtemp™ 421, Digital Ear Thermometer

 This item is not available for sale in Canada

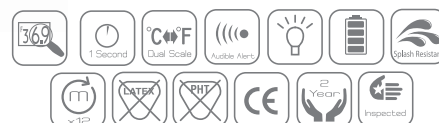

Digital Stick Thermometers



All Models Offer:
 Dual Scale °F/°C
 2-Year Warranty
 Splash Resistance
 Auto-Off
 Last-Reading Memory
 Batteries Included

ADC offers one of the largest selections of cost-effective digital stick thermometers to meet virtually any clinical setting. Our selection and unmatched quality control are why ADC's digital stick thermometer line is considered one of the best in the US.

- ✓ Eight distinct models
- ✓ Variety of packaging options and price points
- ✓ Measurement times from six to 60 seconds
- ✓ Flexible tip models for pediatric patient safety
- ✓ Specialty models for hypothermia or veterinary use
- ✓ All meet accuracy requirements for intermittent thermometers under ASTM E1112



Adtemp™ universal thermometer sheaths, compatible with all ADC digital stick thermometers and most competing brands, are available in a number of packaging options.

Model	Type	Range	Accuracy	Response Time	Flex Probe	Sheaths Included	Sold by	Additional Packaging Options
412-00	Oral/Rectal/Axillary	90.0°F-110.0°F (32.0°C-43.9°C)	±0.2°F (±0.1°C)	60 sec	No	No	20/box	412K ¹
413*	Oral or Rectal	90.0°F-109.9°F (32.0°C-42.9°C)	±0.2°F (±0.1°C)	30 sec	No	Yes	12/box	413*K ¹ 413*-00 ²
415FL	Oral/Rectal/Axillary	90.0°F-109.9°F (32.0°C-43.9°C)	±0.2°F (±0.1°C)	10/18 sec	Yes	Yes	12/box	415K ¹
418N	Oral/Rectal/Axillary	93.2°F-109.9°F (34.0°C-42.9°C)	±0.2°F (±0.1°C)	8 sec	Yes	Yes	12/box	N/A
419	Hypothermia	78.8°F-111.0°F (26.0°C-43.9°C)	±0.2°F (±0.1°C)	10/18 sec	No	Yes	12/box	N/A
422	Veterinary	90.0°F-109.9°F (32.0°C-43.9°C)	±0.2°F (±0.1°C)	10 sec	No	Yes	ea.	N/A
426F	Oral/Rectal/Axillary	89.6°F-109.8°F (32.0°C-43.2°C)	±0.3°F (±0.2°C)	10 sec	Yes	Yes	ea.	N/A
427	Temple Touch	95.0°F-107.6°F (35.0°C-42.0°C)	±0.2°F (±0.1°C)	6 sec	No	N/A	12/box	427Q ³

* Specify: B for Blue Cap (oral) or R for Red Cap (rectal)

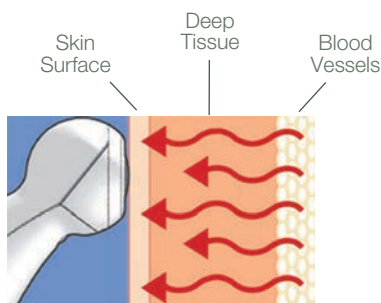

Adtemp™ 427 Temple Touch Thermometer

Provides an accurate six-second, non-invasive temperature reading at the temple making it ideal for pediatric patients. Cost-effective design makes it ideal for institutional use.

The Adtemp™ 427 Temple Touch features

- Non-invasive temple temperature measurement using patented conductive technology delivers clinically accurate readings in about six seconds
- Reduces the risk of cross contamination and avoids the need for costly probe covers
- Ideal for the hospital, clinic, or physician office
- Auto off function conserves battery life
- Audible tone when measurement is complete
- Last-reading memory
- Dual scale (°F/°C)
- Water resistant
- Large display
- Uses two AAA batteries (included)
(Minimum 1000 full-duty cycles over 24-month period)
- Temperature range from 95°F to 107.6°F ± .2°F (35°C to 42°C ± .1°C)
- Compact design measures just 4.7" x 1.17" x 1"
(12.0 cm x 3.0 cm x 2.4 cm)
- Weighs 1.3 oz (37g), including batteries

Ordering Information

Item	Description
427	Adtemp™ 427, Temple Touch Thermometer/Boxed
427Q	Adtemp™ 427, Temple Touch Therm / Display Pkg.

This item is not available for sale in Canada





Ordering Information

Item	Description
418N	Adtemp™ Digital Thermometer

This item is not available for sale in Canada



Adtemp™ 418N Digital Thermometer

An updated version of our most feature-rich digital stick thermometer with ultra-fast response time.

The Adtemp™ 418N thermometer features

- Eight-second measurement using proprietary predictive technology
- Large LCD display with color-coded backlighting (green for readings in the normal range and red for readings above 99.5°F (37.5°C))
- Temperature range from 93.2°F-111.0°F ±.2°F (34°C - 43.9°C ±.1°C)
- Flexible probe tip
- Replaceable 3V (CR2032) battery provides up to 2,000 measurements
- Scabbard-type storage case
- Includes five probe sheaths

Adtemp™ 415FL Digital Thermometer

A super-fast, peak-hold, stick-type digital thermometer with flexible tip.

The Adtemp™ 415FL thermometer features

- 18-second oral, 10-second rectal temperature measurement
- Large LCD for easy reading
- Temperature range from 90°F-109.9°F ±.2°F (32°C - 43.9°C ±.1°C)
- Flexible probe tip
- Replaceable 1.55V (LR41) battery provides up to 4,000 measurements
- Includes five probe sheaths
- Scabbard-type storage case
- Each in box, 12/carton, 144/case



Ordering Information

Item	Description
415FL	Adtemp™ Digital Thermometer / Flex Tip

This item is not available for sale in Canada



Ordering Information

Item	Description
426F	Adimal® Digital Thermometer, Frog

This item is not available for sale in Canada



Adimals® Digital Thermometer

Our digital thermometer with a fresh face.

The Adimals® 426 thermometer features

- Large display for easy reading
- Temperature range from 89.6°F-109.8°F ±.3°F (32°C - 43.2°C ±.2°C)
- Replaceable 1.55V (LR41) battery provides up to 4,000 measurements
- Flexible probe tip
- Includes five probe sheaths
- Scabbard-type storage case
- Water resistant

Adtemp™ 413 Digital Thermometer

Our most popular model of digital stick thermometer.

The Adtemp™ 413 thermometer features

- Compact size: under 5" long, weighs just 11 grams
- Temperature range from 90°F-109.9°F ±.2°F (32°C - 42.9°C ±.1°C)
- Replaceable 1.55V (LR41) battery provides up to 4,500 measurements
- Scabbard-type storage case keeps instrument sanitary
- Boxed unit complete with five sheaths
- Bulk unit packaged 25/box, 500/case
- Specify B for blue cap (oral) or R for red cap (rectal)



Ordering Information

Item	Description
413*	Adtemp™ Digital Thermometer / Boxed
413*-00	Adtemp™ Digital Thermometer / Bulk

*Specify Blue Cap (oral) - B or Red Cap (rectal) - R

This item is not available for sale in Canada



Ordering Information

Item	Description
412-00	Adtemp™ Digital Thermometer / 20/box

This item is not available for sale in Canada



Adtemp™ 412 Digital Thermometer

The ideal mercury-replacement thermometer.

The Adtemp™ 412 thermometer features

- Super-low-cost digital thermometer
- Compact size: under 5" long, weighs just 14 grams
- Temperature range from 90°F-109.9°F ±.2°F (32°C - 43.9°C ±.1°C)
- Audible tone when measurement is complete
- Non-replaceable 1.55V (LR41) battery provides up to 4,500 measurements
- Scabbard-type storage case
- Bulk unit packaged 20/box, 240/case

Adtemp™ 419 Hypothermia Thermometer

World's first digital hypothermia thermometer.

The Adtemp™ 419 hypothermia thermometer features

- Extended range 78.8°F-111.0°F ±.2°F (26°C - 43.9°C ±.1°C)
- Replaceable 1.55V (LR41) battery provides up to 5,000 measurements
- Includes five probe sheaths
- Clear two-piece plastic storage case
- Each in box, 12/carton, 144/case



Ordering Information

Item	Description
419	Adtemp™ Hypothermia Thermometer

This item is not available for sale in Canada





Adtemp™ 422 Veterinary Digital Thermometer

The first digital pen-type thermometer designed for veterinary applications.

The Adtemp™ 422 veterinary thermometer features

- Temperature range 90°F-109.9°F ±.2°F (32.0°C - 43.9°C ±.1°C)
- Replaceable 1.55V (LR41) battery provides up to 5,000 measurements
- Specially designed housing with lanyard attachment for enhanced removal
- Includes five probe sheaths
- Clear two-piece plastic storage case
- Each in box, 12/carton, 144/case

Ordering Information

Item	Description
422	Adtemp™ Veterinary Thermometer

This item is not available for sale in Canada



Adtemp™ Single-Patient-Use Kits

The Adtemp™ SPU Kits features

- Adtemp™ thermometer and 20 Adtemp™ sheaths in a compact, two-pocket vinyl wallet
- Kits packaged one per box
- 12/carton, 144/case



Ordering Information

Item	Description
412K	Adtemp™ Digital SPU Kit, °F/°C, 1/Box
413*K	Adtemp™ Digital SPU Kit, °F/°C, 1/Box
415K	Adtemp™ Flex Digital SPU Kit, °F/°C, 1/Box

*Specify Blue Cap (oral) - B or Red Cap (rectal) - R

This item is not available for sale in Canada



Adtemp™ Disposable Sheaths

The Adtemp™ thermometer sheaths features

- Non-sterile, disposable design helps eliminate cross contamination
- Cost effective and easy to apply
- Suitable for oral or rectal use
- Designed for use with ADC and most comparably sized digital thermometers



Ordering Information

Item	Description
416-50	Adtemp™ Digital Sheaths 50/Box
416-100	Adtemp™ Digital Sheaths 100/Box
416-1000	Adtemp™ Digital Sheaths 1000/Box



Our line of diagnostic EENT instruments totals nearly 900 model options, the largest selection by unique part number in the United States. We offer two brands: economical 2.5V portable Proscope™ models, and feature-rich 2.5V and 3.5V Diagnostix™ instruments in pocket, portable, desk, and wall systems.

Choose from our line of full-size 3.5V and 2.5V diagnostic instruments or compact pocket sets, depending on clinical needs or budget. We offer four different instrument heads, for virtually every type of physical exam:

- **Otoscopes for examination of the inner ear**
- **Ophthalmoscopes for examination of the eye**
- **Throat illuminators for examination of the mouth and throat**
- **Dermoscopes for examination of the skin.**
- **Our 2.5V otoscope is available in a veterinary model, as well.**



PMV
Otoscope
Page 98



Standard
Otoscope
Page 98



Dermoscope
Page 100



Ophthalmoscope
Page 99



Throat
Illuminator
Page 100

Purchase instruments individually or choose one of our popular combination sets, with hard and soft cases for storage.

SOURCED GLOBALLY. INSPECTED, ASSEMBLED and PACKAGED LOCALLY

We contract with the world's leading manufacturers in Pakistan, Germany, and the U.S.A. to produce components to our exacting specifications. Then, using custom-built inspection equipment and factory-trained personnel, we perform rigorous testing in our New York headquarters before the instruments are assembled and packaged.



ADC is one of a few firms to hold our own 510(k) and be classed as a manufacturer of EENT instruments

All ADC otoscopes accommodate Welch Allyn® KleenSpec® disposable ear specula for the ultimate in convenience and affordability.



COMPREHENSIVE WARRANTIES

As with all ADC warranties, coverage for our Diagnostix and Proscope brand EENT instruments is among the industry's most comprehensive.

- **Proscope 2.5V Portable instruments are warranted for one year**
- **Diagnostix 2.5V Pocket instruments are warranted for two years**
- **Diagnostix 3.5V instrument heads, handles, and desk chargers are warranted for two years**
- **Diagnostix Adstation wall transformers and extension modules are warranted for five years**
- **Optical components are warranted for life**
- **Diagnostix AdLED lamps are warranted for life**

Special Medical Student Warranty: Diagnostix 3.5V Portable sets are covered through the second year of residency.

[Learn more about power, lighting, and other features on pages 96-97](#)

Power Options for Any Clinical Need

Our 2.5V portable and pocket instruments are available with alkaline battery handles in pocket (AA) and portable (C) sizes.

Our 3.5V rechargeable battery handles (portable and desktop platforms) utilize Li-ion battery technology – the same found in smart phones, tablets, and electric cars. Combined with super-efficient LED lamps, our Li-ion battery provides up to 50 hours continuous operation between charges (compared to just two to three for NiMH or NiCad) and a whopping 1,200 charging cycles – 2.5X that of NiMH or NiCad. That means nearly four years of daily recharging, even longer if charged less often.

ADC's 3.5V Portable Diagnostix line has a **new USB rechargeable handle option!**
See page 101



Build Your Own

Our online Diagnostix Builder lets you create your perfect portable, desk, or wall configuration. Compare options and mix and match the features you're looking for.

www.adctoday.com/diagnostix/build



ADC Adstations include a universal power supply with US plug. For international use, our Global Adapter Kit (item 5660TN-GAK) can be ordered separately. The kit includes three replacement plugs for the EU, UK, and Australia that connect to our universal power supply.



Diagnostic Adstation
See pages 109-112

A Range of Illumination Options

Our **portable 2.5V instruments** are available with low-cost vacuum lamps.

Pocket instruments offer xenon illumination for a brighter, whiter light (3,200K), or AdLED lighting for true tissue color (4,200K).

Our **3.5V instruments** are available with either xenon lamps or our third generation LED technology — known as AdLED — for the ultimate in performance.



Adtronic™ Light Control

Our 2.5V portable instruments offer mechanical rheostatic light control. Our 3.5V instruments feature patented **Adtronic Electronic Rheostatic** light output control that provides infinite, continuously variable control. And because it's electronic, we built in an auto-off feature that engages after two minutes of inactivity to further conserve battery strength and lamp life.

Comparing 3.5V Lighting Options



Xenon provides a bright white light (3,200K) with cooler operating temperatures.

AdLED provides near-perfect performance with a color temperature of 4,200K, 17,000 lux, 90+ color rendering index (CRI), and a life expectancy of 100,000 hours (compared with 20-30 hours for xenon). When combined with our Li-ion battery technology AdLED bulbs extend performance to levels never before achieved in an EENT instrument.

Diagnostix AdLED lights are warranted for life.



Pocket Sets: Available in six colors!

ADC's Pocket Series Diagnostic Instruments include both an Otoscope and Ophthalmoscope. Choice of LED or xenon illumination and a compact size make these indispensable instruments for today's busy practitioner.



Diagnostix 5110N:
Our compact, single-handle
pocket set.
See page 106

OTOSCOPES



Diagnostic™ 3.5V PMV (Panoramic Magnified View) Otoscope Head - Item 5422

- Twice the field of view and 66% greater magnification (11 mm field of view, 5X magnification) compared to standard otoscopes
- Significantly improved view of the auditory canal and tympanic membrane
- Fiber-optic light transmission for an unobstructed view
- Choose xenon or high-performance AdLED illumination
- Reflection-optimized, high-performance glass optics
- Adjustable focal depth
- Suitable for throat illumination and pneumatic otoscopy (insufflator sold separately)
- Compatible with Welch Allyn specula
- Anti-theft locking feature is standard
- Works with ADC's 5460, 5463, 5560, and 5660 handles (universal bayonet mount also compatible with other brands of 3.5V handles)
- Two-year warranty on instrument head
- Lifetime warranty on LED lamp
- Manufactured in Germany, inspected and packaged in the U.S.A.
- Specify "X" for xenon or "L" for LED when ordering



Diagnostic™ 3.5V Otoscope Instrument Head - Item 5420

- Fiberoptic light transmission for an unobstructed view
- Optical glass reduces reflection and provides 3x magnification
- Bidirectional swivel lens allows instrumentation
- Insufflator fitting for pneumatic otoscopy
- Compatible with Welch Allyn specula
- Instrument head uses universal bayonet mount for compatibility with other brands of 3.5V handles
- Anti-theft locking feature is standard
- Works with 5460, 5463, 5560, and 5660 handles
- Choose xenon or high-performance AdLED illumination
- Manufactured in Germany, inspected and packaged in the U.S.A.
- Two-year warranty on instrument
- Lifetime warranty on LED lamp
- Specify "X" for xenon or "L" for LED when ordering



Diagnostic™ 2.5V Pocket Otoscope Instrument Head - Item 5120N

- Choose AdLED or 2.5V xenon lamp for true tissue color
- Fiber optic light transmission for an unobstructed view
- Wide-angle swivel 2.5X viewing lens permits instrumentation
- Insufflator port for pneumatic otoscopy (fitting and insufflator sold separately)
- Works with 5160N handle
- Two-year warranty on instrument
- Manufactured in Pakistan, inspected and packaged in the U.S.A.
- Available in black, green (GR), royal blue (RB), purple (V), burgundy (BD), or gray (G)
- Specify "L" for LED when ordering



Proscope™ 2.5V Otoscope Instrument Head - Item 5220

- 2.5V vacuum lamp
- Direct illumination
- Bayonet locking mount
- Removable 3X magnifying lens
- Includes autoclavable, polypropylene ear specula in sizes 2.5mm, 3.5mm, and 4.5mm
- Welch Allyn disposable specula adapter included
- Works with 5211-5 battery handle
- One-year warranty on instrument
- Manufactured in Pakistan, inspected and packaged in the U.S.A.

OPHTHALMOSCOPES

Diagnostix™ Coax and Coax Plus 3.5V Ophthalmoscope Instrument Heads



- High-performance aspherical condenser lens reduces corneal reflection
- Ergonomic design and integral thumb rest improves stability and allows one-finger control of all functions
- Dust-proof housing and soft synthetic rubber brow rest for use with eyeglasses
- Magnified/illuminated aperture viewing window
- Works with ADC's 5460, 5463, 5560, and 5660 handles; universal bayonet mount also compatible with other brands of 3.5V handles
- Anti-theft locking feature is standard
- Choose xenon or high-performance AdLED
- Two-year warranty on instrument
- Lifetime warranty on LED lamp
- Specify "X" for xenon or "L" for LED when ordering

- Twenty-four aperture/filter combinations for improved versatility
- Coax Plus Ophthalmoscope (Item 5442) also includes:**
- Eighty-nine viewing lenses
Plus: single step from 1-45; Minus: single step from 1-44
 - Secondary focusing wheel with zero retention for quick correction of ametropias, provides virtually unlimited fine focus or fast focus in lieu of the 89 viewing lenses
 - Twenty-eight aperture/filter combinations for improved versatility



5440

Coax Ophthalmoscope (Item 5440) also includes:

- Twenty-nine viewing lenses from -35 to +40
Plus: 1-10, 12, 15, 20, 40; Minus: 1-10, 15, 20, 25, 30, 35



5442

Diagnostix™ 2.5V Pocket Ophthalmoscope Instrument Head - Item 5140N



- Choose AdLED or 2.5V xenon lamp for true tissue color
- Five aperture selections: small spot, large spot, semicircle, fixed, and red-free filter
- Nineteen viewing lenses from -20 to +20 diopters for better resolution
- Illuminated magnified lens dial
- Soft synthetic rubber brow rest is helpful when using with eyeglasses

- Meets or exceeds ISO 10942, ISO 15004-1, and ISO 15004-2
- Works with 5160N handle
- Two-year warranty on instrument
- Manufactured in Pakistan, inspected and packaged in the U.S.A.
- Available in black, green (GR), royal blue (RB), purple (V), burgundy (BD), or gray (G)
- Specify "L" for LED when ordering

Proscope™ 2.5V Ophthalmoscope Instrument Head - Item 5240



- 2.5V vacuum lamp
- 24 corrective lenses from -25 to +40 diopters
- Medium spot aperture
- Bayonet locking mount

- Works with 5211-5 handle
- One-year warranty
- Manufactured in Pakistan, inspected and packaged in the U.S.A.

THROAT ILLUMINATORS



Diagnostix™ 3.5V Throat Illuminator Instrument Head - Item 5426

- PMMA light transmission
- Tongue blade holder facilitates examination of the mouth and throat
- Manufactured in Germany, inspected and packaged in the U.S.A.
- Eject button discards used tongue blade
- Works with 5460, 5560, and 5660 handles
- Two-year warranty on instrument
- Lifetime warranty on LED lamp

Specify "X" for xenon or "L" for LED when ordering

DERMASCOPES



Diagnostix™ 3.5V Dermoscope Instrument Head - Item 5450

- Direct illumination
- Optical grade 10X focusable magnifying lens
- Large knurled focusing ring
- Removable contact plate with mm scale
- Soft synthetic rubber eyepiece is helpful when using with eyeglasses
- Anti-theft locking feature is standard
- LED illumination only
- Two-year warranty on instrument
- Lifetime warranty on LED lamp



Proscope™ 2.5V Dermoscope Instrument Head - Item 5312-3

- Bright 2.5V halogen illumination ensures true tissue color for accurate identification
- 10X optic system
- Removable contact plate is autoclavable
- Large knurled focusing ring
- Reticule contact plate etched onto the lens in millimeters permits easy measurement of suspicious lesions
- Bayonet locking mount
- Soft synthetic rubber eyepiece is helpful when using with eyeglasses
- Works with 5260 handle
- One-year warranty on instrument
- Manufactured in Pakistan, inspected and packaged in the U.S.A.

Power Supply

Diagnostix™ 3.5V Global Adapter Kit

Our Global Adapter Kit is a set of three AC plugs that can convert our Diagnostix 3.5V universal power supply for use outside the U.S.



Global Adapter Kit

- Includes three replacement plugs for the EU, UK, and Australia (Power cord not included.)
- Plugs quickly connect to the universal power supply that ships with Diagnostix Adstation wall transformers and extension modules, as well as the Diagnostix desk set charging station
- Two-year warranty

Ordering Information

Item	Description
5660TN-GAK	Global Adapter Kit, EU, UK, AU



Diagnostix™ 3.5V Plug-In Rechargeable Handle

- C-sized handle with rechargeable 1400mAh Li-ion battery
- Top half of handle unscrews to access wall plug (US and Euro fittings available)
- Li-ion battery provide 2.5 hours continuous use with Xenon, 6.5 hours use with LED when charged for 24 hours
- Bayonet mount works with all ADC 3.5V heads (5420, 5442, 5440, 5442, 5450, and 5426) and is compatible with all other major brands
- Handle is CNC machined from solid brass then chrome plated in black with a ribbed surface for a sure grip
- Adtronic™ electronic rheostatic control provides infinite light control and auto-off
- Two-year warranty



Ordering Information	Description
Item	
5460BAT	Replacement battery for 5460



Ordering Information	Description
Item	
5463BAT	Replacement battery for 5463



Diagnostix™ 3.5V USB Rechargeable Handle

- C sized handle with USB rechargeable 18650 Li-ion battery, 3.5V, 2600 mAh, 9.62Wh
- USB-C charging cord included
- Li-ion battery provide 3.5 hours continuous use with Xenon, 10 hours use with LED when charged for 24 hours
- Bayonet mount works with all ADC 3.5V heads (5420, 5442, 5440, 5442, 5450, and 5426) and is compatible with all other major brands
- Handle is CNC machined from solid brass then chrome plated in black with a ribbed surface for a sure grip
- Adtronic™ electronic rheostatic control provides infinite light control and auto-off
- Two-year warranty



Ordering Information	Description
Item	
5560BAT	Replacement battery for 5560



Diagnostix™ 3.5V Desk Rechargeable Handle

- C-sized handle with rechargeable 2600mAh Li-ion battery
- Requires Desk Charger Base, Item 5500, sold separately
- Li-ion battery provides 2-3 hours of continuous use with xenon lamps and up to 50 hours of continuous use with LED lamps
- Bayonet mount works with all ADC 3.5V heads (5420, 5442, 5440, 5442, 5450, and 5426) and is compatible with all other major brands
- Handle is CNC machined from solid brass then chrome plated in black with a ribbed surface for a sure grip
- Adtronic™ electronic rheostatic control provides infinite light control and auto-off
- Two-year warranty



Desk Recharger

Ordering Information	Description
Item	
5500	3.5V Diagnostix™ Desk Recharger



5660TN-GAK	Global Adapter Kit, EU, UK, AU
-------------------	--------------------------------

Diagnostix™ 3.5V Desk Recharger

- Compact and portable desk charging station for two Diagnostix™ rechargeable 5560 handles
- Includes reducing sleeve for use with smaller AA sized handles
- Colored LED power indicator displays charging state
- Storage compartment accommodates a small selection of specula or spare lamps
- Includes wall-mount bracket for permanently mounting to wall or cabinet
- Includes universal power supply with U.S. plug; for international use, our Global Adapter Kit (5660TN-GAK) can be ordered separately



Diagnostix™ 2.5V Pocket Battery Handle

- AA 2.5V battery handle
- On/Off power switch integrated into pocket clip
- Metal-lined thermoplastic barrel
- Two-year warranty
- Manufactured in Pakistan, inspected and packaged in the USA
- Works with 5120N and 5140N instrument heads
- Available in black, green (GR), royal blue (RB), purple (V), burgundy (BD), or gray (G)

Ordering Information

Item	Description
5160N*	Diagnostix™ 2.5V Pocket Battery Handle



* Specify "BD" for Burgundy, "G" for Gray, "GR" for Green, "RB" for Royal Blue, or "V" for Purple when ordering. (Black is standard.)

Proscope™ 2.5V Portable Handles

- C-cell 2.5V power supply
- Rheostatic illumination control
- Knurled brass handle for positive grip
- Bayonet locking mount
- One-year warranty
- Manufactured in Pakistan, inspected and packaged in the USA
- 5211-5 works with 5220, 5240, and 5215-TH instrument heads
- 5260 works with 5312-3 instrument head

Ordering Information

Item	Description
5211-5	Proscope™ 2.5V Portable Handle / Oto, Oph, Throat Illum.
5260	Proscope™ 2.5V Portable Handle / Dermoscope



Diagnostix™ Adstation™ Wall Transformer and Wall Extension Module

- Wall-mount power supply helps improve workflow
- Start with a single power handle and add up to three extension modules
- Magnetic switch activates power when handle is removed from cradle, automatically powers off when handle is replaced
- Adtronic™ electronic rheostatic light-intensity control provides infinite continuous control
- Adtronic™ auto-off feature after two minutes provides additional safety if instrument is mis-cradled
- Easy to install with included bracket or may be mounted to our wallboard systems
- Bayonet instrument mount is compatible with all major brands of 3.5V instrument heads
- Includes universal power supply with U.S. plug. For international use, our Global Adapter Kit (5600TN-GAK) can be ordered separately
- Five-year warranty
- Works with 5420, 5422, 5440, 5442, 5450, and 5426 instrument heads



Ordering Information

Item	Description
5660T	Diagnostix™ Adstation™ Wall Transformer
5660E	Diagnostix™ Adstation™ Wall Extension Module
5660TN-GAK	Global Adapter Kit, EU, UK, AU





Diagnostix™ Desk Sets

The Diagnostix™ Desk Set features

- Compact and portable desk charging station for two Diagnostix™ rechargeable handles (5560)
- Reducing sleeve to allow use with smaller AA-sized handles
- Colored LEDs indicate power and charging state
- Handles charge fully overnight, providing three hours continuous use with xenon lamps or 50 hours continuous use with LED lamps
- Storage compartment accommodates a small selection of specula or spare lamps
- Includes wall-mount bracket for permanently mounting to wall or cabinet
- Includes universal power supply with U.S. plug. For international use, our Global Adapter Kit (5660TN-GAK) can be ordered separately

Ordering Information

Item	Description
5510*	Diagnostix™ Desk Set, Otoscope, Coax Ophthal
55102*	Diagnostix™ Desk Set, Otoscope, Coax Plus Ophthal
5580*	Diagnostix™ Desk Set, PMV Otoscope, Coax Ophthal
55802*	Diagnostix™ Desk Set, PMV Otoscope, Coax Plus Ophthal
5660TN-GAK	Diagnostix™ Global Adapter Kit, EU, UK, AU

Diagnostix™ Desk Set Model Descriptions



Component Model	5422 PMV Otoscope	5420 Standard Otoscope	5440 Coax Ophthal.	5442 Coax Plus Ophthal.	5560 Handle (x2)	5500 Desk Charger
5580*	✓		✓		✓	✓
55802*	✓			✓	✓	✓
5510*		✓	✓		✓	✓
55102*		✓		✓	✓	✓

* Indicates lamps: X = Xenon, L = LED, A = LED Otoscope & Xenon Ophthalmoscope, B = Xenon Otoscope & LED Ophthalmoscope





USB Rechargeable Handle Now Available!



Diagnostix™ 3.5V Portable Instruments

3.5V Diagnostic EENT instruments are among the most critical tools for a comprehensive physical exam.

The Diagnostix™ Portable Set features

- Choose from 3.5V Diagnostix™ Coax or Coax Plus Ophthalmoscope
- Choose from a 3.5V Diagnostix™ standard otoscope or our PMV otoscope
- USB or Plug-In Li-ion Adtronic™ battery handle (see page 101)
- Soft and hard case options depending upon configuration
- 3.5V Throat Illuminator or Dermoscope available
- Choose xenon or AdLED™ lighting technology
- Two-year warranty on instrument heads and handle, lifetime on LED lamp

Component Model									
54380* ‡	✓		✓				✓	✓	✓
543802* ‡	✓			✓			✓	✓	✓
54381*	✓						✓		✓
54310* ‡		✓	✓				✓	✓	✓
543102* ‡		✓		✓			✓	✓	✓
54311*		✓					✓		✓
54312*			✓				✓		✓
543122*				✓			✓		✓
54316*					✓		✓		✓
54313						✓	✓		✓

3 Add a 3 to model number to specify USB-C rechargeable handle; leave out when ordering socket plug-in rechargeable handle
 * Indicates lamps: X = Xenon, L = LED, A = LED Otoscope & Xenon Ophthalmoscope, B = Xenon Otoscope & LED Ophthalmoscope
 ‡ Hard case is standard. Add "S" for soft case



Diagnostix™ 2.5V Pocket Instruments

Full-featured pocket sets that sacrifice nothing but size.

The Diagnostix™ Pocket Set features

- Compact portability with a feature-rich design
- AA handle with integrated pocket clip
- Choose from our 2.5V fiber-optic Pocket Otoscope and 2.5V Pocket Ophthalmoscope instrument heads
- Choose xenon illumination for a bright white light and true tissue color or high-performance AdLED™ lighting

- Instruments available individually or in complete two-instrument diagnostic sets
- Available in black, green (GR), royal blue (RB), purple (V), burgundy (BD), or gray (G)
- Offered in either hard fitted or soft nylon storage case
- AA batteries included
- Disposable specula included with Otoscopes
- Spare lamps included with xenon sets (not with LED sets)
- Inspected, assembled, and packaged in the USA from foreign components
- Two-year instrument warranty, lifetime on optics

Ordering Information

Item	Description
5110E**	Diagnostix™ Single Handle, Otoscope/Ophthal
5110N*S**	Diagnostix™ Dual Handle, Otoscope/Ophthal, Soft Case
5110N* **	Diagnostix™ Dual Handle, Otoscope/Ophthal, Hard Case
5111N*S**	Diagnostix™ Single Handle, Otoscope, Soft Case
5111N* **	Diagnostix™ Single Handle, Otoscope, Hard Case
5112N*S**	Diagnostix™ Single Handle, Ophthalmoscope, Soft Case
5112N* **	Diagnostix™ Single Handle, Ophthalmoscope, Hard Case

- * Indicates lamp Choice: L = LED
- ** Add BD for Burgundy, G for Gray, GR for Green, RB for Royal Blue, or V for Purple. (Black is standard).

LED Component Model	Xenon Component Model	5120N Otoscope	5140N Ophthalmoscope	5160N Handle	Hard Case	Soft Case 9251XXS
N/A	5110E**	✓	✓	✓	✓	
5110NLS**	5110NS**	✓	✓	✓ (x2)		✓
5110NL**	5110N**	✓	✓	✓ (x2)	✓	
5111NLS**	5111NS**	✓		✓		✓
5111NL**	5111N**	✓		✓	✓	
5112NLS**	5112NS**		✓	✓		✓
5112NL**	5112N**		✓	✓	✓	

** Specify "BD" for Burgundy, "G" for Gray, "GR" for Green, "RB" for Royal Blue, or "V" for Purple when ordering. (Black is standard.)





5211



5215

Proscope™ 2.5V Portable Instruments

ADC's Proscope™ portable instruments offer a wide selection of diagnostic capabilities at budget-friendly pricing.

The ADC 2.5V Diagnostic Set features

- Ophthalmoscope head with lens wheel features 24 corrective lenses from -25 to +40 diopters
- Otoscope head with removable 3X magnifying lens and insufflator fitting
- Bayonet head locking mounts for secure connection to the battery handle
- Welch Allyn disposable polypropylene ear specula in 2.75mm and 4.25mm sizes
- C-cell powered battery handle with rheostatic on/off switch
- Auto-clavable, polypropylene ear specula in 2.5mm, 3.5mm, and 4.5mm sizes
- Adapter to allow use with Welch Allyn or compatible disposable specula
- Sets complete in zippered case with fitted, scratch-resistant, and easy-to-clean insert; single instruments offered in nylon case
- Inspected and packaged in the USA from foreign components
- Batteries NOT included
- One-year warranty



Component Model	5220 Otoscope	5240 Ophthalmoscope	5312-3 Dermoscope	5215-TH Throat Illum.	5211-AD Specula Adapter	5215-NS Nasal Spec.	5215-TD Tongue Dep.	5215-M3 5215-M4 Mirrors	Handle	5211-6 Spec.	Hard Case	Soft Case
5211*	✓				✓				5211-5	✓		✓
5212		✓							5211-5			✓
5312			✓						5260			✓
5210	✓	✓			✓				5211-5	✓	5210-ZC	
5215	✓	✓		✓	✓	✓	✓	✓	5211-5	✓	5215-ZC	

*Also available in veterinary model (5211V) with specula sizes 4, 5, and 7

Diagnostic Replacement Lamps

Ordering Information





Item	Welch Allyn	Description/Use In
4500-1	00110	2.5V ADC/WA Laryngoscopes Mac 0, 1, 2; Miller 00, 0, 1; Wis 0, 1, 1.5; All other WA blades
4501-1	00400	2.5V ADC/WA Laryngoscopes Mac 3, 4, Miller 2-4; Wis 2, 3, 4; All other WA blades 2-4
4502-1	00200	2.5V WA Otoscopes, Finoff & Briggs Translum, Tongue Depressor Anoscopes, Bivalve Nasal Spec, Spec Illum, Ocular Pocket Light
4504-1	00800	6V Halogen Vaginal Spec (1 pk.)
4504A-1	08800	4.6V Halogen Vaginal Spec (1 pk.)
4507-1	01300	2.5V ADC Penlights #354
4513-1	03000	3.5V Halogen WA Ophthalmoscope
4514-1	03100	3.5V Halogen WA Otoscope

Ordering Information

Item	Welch Allyn	Description/Use In
4516-1	03400	2.5V Halogen WA Otoscope
4518-1	03900	2.5V Halogen WA Ophthalmoscope
4522-1	04900	3.5V Halogen WA Ophthalmoscope
4523-1	06000	2.5V Halogen WA Laryngoscope
5111N-4	N/A	2.5V for 5110N, 5111N, 5110E, 4065F, 4066F, 4067F
5112N-4	N/A	2.5V for 5110N, 5112N, 5110E
5210-4	N/A	2.5V for 5210, 5212, 5215
5211-4	N/A	2.5V xenon for 5210, 5211, 5211V, 5215
5112NL-4	Not pictured	2.5V LED for 5110N, 5112N, 5110E



Comparison Chart: 3.5V Desk Sets

				
General Set Features	5510‡	55102‡	5580‡	55802‡
Type	Desk	Desk	Desk	Desk
Voltage	3.5V	3.5V	3.5V	3.5V
Standard Lamp	Xenon	Xenon	Xenon	Xenon
LED Lamp Model Available	Yes	Yes	Yes	Yes
Total Set Weight	39 oz	39 oz	41 oz	41 oz
Total Model Options	4	4	4	4
Warranty*	2 Years	2 Years	2 Years	2 Years
Handle Features				
Number Supplied	2	2	2	2
Switch Type	Electronic Rheostat	Electronic Rheostat	Electronic Rheostat	Electronic Rheostat
Battery Type	Li-Ion	Li-Ion	Li-Ion	Li-Ion
Rechargeable	Yes	Yes	Yes	Yes
Ophthalmoscope Features				
Type	Coax	Coax Plus	Coax	Coax Plus
Lenses	29	89	29	89
Diopter Range	-35 to +40	-44 to +45	-35 to +40	-44 to +45
Secondary Focusing Wheel	No	Yes	No	Yes
Apertures	6	7	6	7
Filters	4	4	4	4
Polarized Filter Option	Yes	Yes	Yes	Yes
Instrument Length (with handle)	9 in	9 in	9 in	9 in
Instrument Weight (with handle)	12 oz	12 oz	12 oz	12 oz
Otoscope Features				
Type	Standard	Standard	PMV	PMV
Light Transmission	Fiberoptic	Fiberoptic	Fiberoptic	Fiberoptic
Magnifying Lens	3X	3X	5X	5X
Focusing Wheel	No	No	Yes	Yes
Specula Type Available (included)	Disposable	Disposable	Disposable	Disposable
Instrument Length (with handle)	8.25 in	8.25 in	8.5 in	8.5 in
Instrument Weight (with handle)	11.3 oz	11.3 oz	12.7 oz	12.7 oz
Additional Features				
Additional instrument Heads Available	Yes	Yes	Yes	Yes

NOTE: ‡ Various suffix codes required to denote lamping options: X = Xenon; L = LED; A = LED Otoscope and Xenon Ophthalmoscope; B = Xenon otoscope and LED ophthalmoscope
* LED models carry lifetime warranty on lamp

Comparison Chart: 2.5V and 3.5V Pocket and Portable Sets



General Set Features	5110‡	5210	5215	5410‡/54310‡	54102‡/543102‡	5480‡/54380‡	54802‡/543802‡
Type	Pocket	Portable	Portable	Portable	Portable	Portable	Portable
Voltage	2.5V	2.5V	2.5V	3.5V	3.5V	3.5V	3.5V
Standard Lamp	Xenon	Vacuum	Vacuum	Xenon	Xenon	Xenon	Xenon
LED Lamp Model Available	Yes	No	No	Yes	Yes	Yes	Yes
Hard Case Option	Yes	Yes	Yes	Yes	Yes	Yes	Yes
Soft Case Option	Yes	No	No	Yes	Yes	Yes	Yes
Instrument Length (with handle)	6½ in	7¼ in - 8¼ in	7¼ in - 8¼ in	8¼ in - 9 in	8¼ in - 9 in	8½ in - 9 in	8½ in - 9 in
Instrument Weight (with handle)	4 oz - 4.5 oz	11.9 oz - 12.6 oz	11.9 oz - 12.6 oz	11.3 oz - 12.1 oz	11.3 oz - 12.1 oz	12.1 oz - 12.7 oz	12.1 oz - 12.7 oz
Set Dimensions in Hard Case	7¼" x 4½" x 1½"	9½" x 7¾" x 2¾"	9½" x 7¾" x 2¾"	9" x 5½" x 1¾"	9" x 5½" x 1¾"	9" x 5½" x 1¾"	9" x 5½" x 1¾"
Set Dimensions in Soft Case	7" x 3¾" x 1½"	N/A	N/A	6½" x 3¾" x 2½"	6½" x 3¾" x 2½"	6½" x 3¾" x 2½"	6½" x 3¾" x 2½"
Total Set Weight	10.7 oz to 17.1 oz	28 oz	30.5 oz	17.3 oz - 24 oz	17.3 oz - 24 oz	18.8 oz - 26 oz	18.8 oz - 26.1 oz
Colors Available	Black, Royal Blue Burgundy, Green Gray, Purple	Black/Silver	Black/Silver	Black	Black	Black	Black
Total Model Options	30	1	1	8	8	8	8
Warranty*	2 Years	1 Year	1 Year	2 Years	2 Years	2 Years	2 Years

Handle Features

Number Supplied	1 or 2	1	1	1	1	1	1
Switch Type	On/Off	Mechanical Rheostat	Mechanical Rheostat	Electronic Rheostat	Electronic Rheostat	Electronic Rheostat	Electronic Rheostat
Battery Type	AA x2	C x2	C x2	Li-Ion	Li-Ion	Li-Ion	Li-Ion
Rechargeable	No	No	No	Plug in and USB ³	Plug in and USB ³	Plug in and USB ³	Plug in and USB ³
Pocket Clip	Yes	No	No	No	No	No	No

³ USB models begin with 543

Ophthalmoscope Features

Type	Standard	Mayfield	Mayfield	Coax	Coax Plus	Coax	Coax Plus
Lenses	19	24	24	29	89	29	89
Diopter Range	-20 to +20	-25 to +40	-25 to +40	-35 to +40	-44 to +45	-35 to +40	-44 to +45
Secondary Focusing Wheel	No	No	No	No	Yes	No	Yes
Apertures	5	1	1	6	7	6	7
Filters	1	0	0	4	4	4	4
Polarized Filter Option	No	No	No	Yes	Yes	Yes	Yes

Otoscope Features

Type	Standard	Standard	Standard	Standard	Standard	PMV	PMV
Light Transmission	Fiberoptic	Direct	Direct	Fiberoptic	Fiberoptic	Fiberoptic	Fiberoptic
Magnifying Lens	2.5X	3X	3X	3X	3X	5X	5X
Focusing Wheel	No	No	Yes	Yes	Yes	Yes	Yes
Specula Type Available (included)	Disposable	Disposable/ Reusable	Disposable/ Reusable	Disposable	Disposable	Disposable	Disposable

Additional Features

Additional Instrument Heads Included	No	No	Yes	No	No	No	No
Additional Instrument Heads Available	No	Yes	No	Yes	Yes	Yes	Yes

‡ Various suffix codes required to denote case type (i.e., "S" for soft), lamping (i.e., "L" for LED), and where applicable color.

* LED models carry lifetime warranty on lamp.

Diagnostix 3.5V Adstation



See pages 104 and 105 for our most popular configurations. Or visit our online Diagnostix Builder tool to mix and match the features you're looking for.



adctoday.com/diagnostix/build

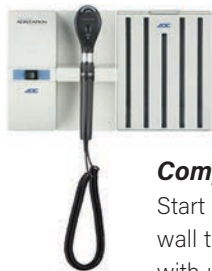

Completely Modular

Start with a single-instrument wall transformer and expand with up to three more connected extension modules

ADC's Diagnostix 3.5V Adstation offers a complete diagnostic solution, putting a full assortment of core tools within easy reach. With our modular system, you can start with a single EENT tool, then add up to three additional instruments plus blood pressure and thermometry.

Instrumentation:

- Coax or Coax Plus Ophthalmoscope
- Standard or PMV Otoscope
- Throat Illuminator and Dermoscope also available

Blood Pressure:

- Clock Aneroid Sphygmomanometer
- ADView 2 Modular Diagnostic Station
- e-sphyg 3 Digital Blood Pressure Monitor



French cleat mounting

New, Simplified Wallboard!

We've updated our Adstation wallboard to a universal one-size design. Made of a compressed particle board, the new system uses a French cleat mount that's fully compatible with competitive designs, allowing for a quick installation on existing hardware. New installations ship with all assembly hardware and an easy-to-use template to simplify mounting.

Popular Adstation Configurations



Shown here: Model 5610-39W
with Advview 2
(Model 9005BPT)

Advview 2 is ordered as
a separate item.

Advview 2

Learn more about the
Advview 2 on page 5.

Diagnostix Adstation™ with Advview 2

3.5V Modular Diagnostix Wall System
with Advview 2

- Advview 2 modular diagnostic station with optional pulse oximetry and thermometry
- 3.5V Diagnostix Coax Plus Ophthalmoscope or Coax Ophthalmoscope
- 3.5V Diagnostix PMV Otoscope or Standard Otoscope with specula dispenser
- Add a 429 Non-Contact Thermometer
- Add a 3.5V Diagnostix Throat Illuminator or Dermoscope
- Choose from Halogen/Xenon or high-performance AdLED lighting technology



Shown here:
5680-347
with PMV Otoscope,
Non-Contact Thermometer,
Clock Aneroid
and Wallboard

Diagnostix Adstation™ with Clock Aneroid

3.5V Modular Diagnostix
Wall System with Clock Aneroid

- Diagnostix Clock Aneroid with cuff storage basket, coiled tubing, adult and large adult inflation systems
- 3.5V Diagnostix Coax Plus Ophthalmoscope or Coax Ophthalmoscope 3.5V Diagnostix PMV Otoscope or Standard Otoscope with specula dispenser
- Adtemp 429 Non-Contact Thermometer
- Choose from Halogen/Xenon or high-performance AdLED lighting technology
- Optional wall board for simplified mounting



Shown here:
Model 5680-38W
with e-sphyg 3
(Model 9003-MCC)

**e-sphyg 3 is ordered
as a separate item.**

e-sphyg 3™

Learn more about the
e-sphyg 3 on page 6.

Diagnostix Adstation™ with e-sphyg 3
3.5V Modular Diagnostix Wall System
with e-sphyg 3

- E-sphyg 3 NIBP monitor
- 3.5V Diagnostix Coax Plus Ophthalmoscope or Coax Ophthalmoscope
- 3.5V Diagnostix PMV Otoscope or Standard Otoscope with specula dispenser
- Add a 429 Non-Contact Thermometer
- Choose from Halogen/Xenon or high-performance AdLED lighting technology

Diagnostix Adstation™

Basic 3.5V Diagnostix Wall System

- 3.5V Diagnostix Coax Plus Ophthalmoscope or Coax Ophthalmoscope
- 3.5V Diagnostix PMV Otoscope or Standard Otoscope with specula dispenser
- Choose from Halogen/Xenon or high-performance AdLED lighting technology
- Optional wall board for simplified mounting

Can be ordered
as single
instrument.



Shown here:
Model 5613
with Dermoscope



Shown here:
Model 5610-3 with
Standard Otoscope

Adstation Model Chart



Component Model	5422 PMV Otoscope	5420 Standard Otoscope	5440 Coax Ophthal	5442 Coax Plus Ophthal	5630 Specula Dispenser	5426 Throat Illuminator	5450 Dermoscope	750W Clock Aneroid	9005BPSTO ADView 2	9003K-MCC e-sphyg 3	5660T Transformer	5660E Extension	429 Non-Contact Thermometer	Wall Board
5681*	X										X			
5611*		X									X			
5681*-3	X				X						X			
5611*-3		X			X						X			
5612*			X								X			
56122*				X							X			
5616*						X					X			
5613L							X				X			
5680*	X		X								X	X		
5610*		X	X								X	X		
5680*-3	X		X		X						X	X		
5610*-3		X	X		X						X	X		
5680*-3W	X		X		X						X	X		X
5610*-3W		X	X		X						X	X		X
5680*-37	X		X		X			X			X	X		
5610*-37		X	X		X			X			X	X		
56802*	X			X							X	X		
56102*		X		X							X	X		
56802*-3	X			X	X						X	X		
56102*-3		X		X	X						X	X		
56802*-37	X			X	X			X			X	X		
56102*-37		X		X	X			X			X	X		
56802*-3W	X			X	X						X	X		X
56102*-3W		X		X	X						X	X		X
5680*-37W	X		X		X			X			X	X		X
5680*-347W	X		X		X			X			X	X	X	X
5610*-37W		X	X		X			X			X	X		X
5610*-347W		X	X		X			X			X	X	X	X
5680*-39W	X		X		X					X [‡]	X	X		X
5680*-349W	X		X		X					X [‡]	X	X	X	X
5610*-39W		X	X		X					X [‡]	X	X		X
5610*-349W		X	X		X					X [‡]	X	X	X	X
5680*-38W	X		X		X					X [‡]	X	X		X
5680*-348W	X		X		X					X [‡]	X	X	X	X
5610*-38W		X	X		X					X [‡]	X	X		X
5610*-348W		X	X		X					X [‡]	X	X	X	X

‡ ADView 2 and e-sphyg 3 must be ordered as a separate item.

* Indicates lamps: X = Xenon, L = LED, A = LED Otoscope & Xenon Ophthalmoscope, B = Xenon Otoscope & LED Ophthalmoscope



Several popular configurations of our Diagnostix 3.5V Adstation are shown here, but you can customize your order with hundreds more variations, including the all-new e-sphyg³. Our all-new online Diagnostix Builder tool makes it easy to compare the choices available and mix and match the features you're looking for. Get started at www.adctoday.com/diagnostix/build.

Laryngoscopes



Every Satin reusable laryngoscope is inspected and packaged in the U.S.A. and includes a one-year warranty.

Our Satin™ brand of reusable laryngoscopes are available in a range of blade and illumination styles.

Blades are available in three popular styles: Macintosh, Miller or Wisconsin, in sizes 00 to 4. All blades offer stainless-steel construction with a satin finish for unsurpassed performance and durability.

Lightweight handles are available in three sizes: Medium, Small, and Stubby. Macintosh and Miller profiles can be paired with standard handles or fiber-optic handles, which feature a removable light pipe for simplified disinfection and longer life.

Every Satin reusable laryngoscope is inspected and packaged in the U.S.A. and includes a one-year warranty.

ADC laryngoscope components are compatible with all major brands of laryngoscopes conforming to ISO 7376.

See page 116 for a detailed feature chart.

Order individually or in complete sets featuring a full selection of blades and handles in a fitted case (see page 117).



Fiber-optic handles are color coded green to signify the use of fiberoptic blades

Satin handles designed with a knurled finish for a positive grip.



Available in three sizes: Medium, Small, and Stubby

Macintosh Standard

- Stainless-steel construction with satin, non-glare finish
- The most popular of the curved blade designs

Ordering Information

Item	Blade	Description	Dim A	Dim B	Lamp
4070	0	Preemie	80 mm	58 mm	4500
4071	1	Infant	87 mm	65 mm	4500
4072	2	Child	108 mm	86 mm	4500
4073	3	Medium Adult	128 mm	105 mm	4501
4074	4	Large Adult	159 mm	137 mm	4501



Wisconsin Standard

- Stainless-steel construction with satin, non-glare finish

Ordering Information

Item	Blade	Description	Dim A	Dim B	Lamp
4090	0	Preemie	77 mm	55 mm	4500
4091	1	Infant	102 mm	80 mm	4500
40915	1.5	Small Child	115 mm	93 mm	4500
4092	2	Child	135 mm	112 mm	4501
4093	3	Medium Adult	162 mm	139 mm	4501
4094	4	Large Adult	199 mm	177 mm	4501

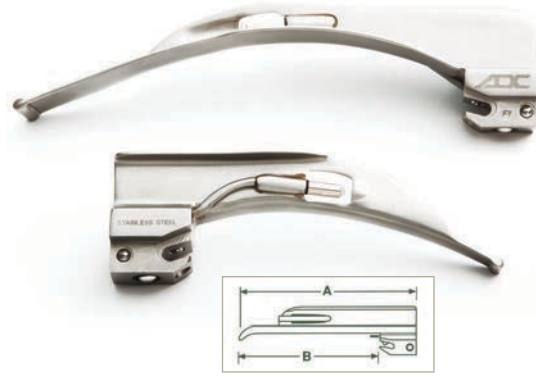

Miller Standard

- Stainless-steel construction with satin, non-glare finish
- The most popular of the straight blade designs

Ordering Information

Item	Blade	Description	Dim A	Dim B	Lamp
4080-0	00	Small Preemie	65 mm	43 mm	4500
4080	0	Preemie	75 mm	53 mm	4500
4081	1	Infant	102 mm	80 mm	4500
4082	2	Child	155 mm	133 mm	4501
4083	3	Medium Adult	195 mm	173 mm	4501
4084	4	Large Adult	205 mm	183 mm	4501



Battery Handles

- Lighter and more ergonomic satin handles have a knurled finish for a positive grip
- Available in traditional C, AA, and stubby (AA)
- Batteries not included

Ordering Information

Item	Description
4065	Medium C-Size Battery Handle
4066	Small AA-Size Battery Handle
4067	Stubby AA-Size Battery Handle



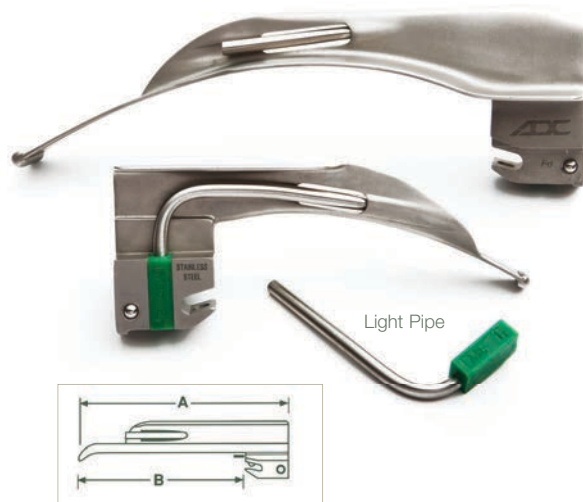

Macintosh Fiberoptic

- Stainless-steel construction with satin, non-glare finish
- Fiber-optic light transmission provides cool, obstruction-free viewing
- 2.5V halogen illumination for true tissue color and long-lasting lamp performance
- Removable light pipe facilitates cleaning and service
- Color coded green to signify compatibility ONLY with fiber-optic handles

Ordering Information

Item	Blade	Description	Dim A	Dim B
4070F	0	Preemie	80 mm	55 mm
4071F	1	Infant	92 mm	67 mm
4072F	2	Child	108 mm	83 mm
4073F	3	Medium Adult	126 mm	101 mm
4074F	4	Large Adult	155 mm	134 mm



Miller Fiberoptic

- Stainless-steel construction with satin, non-glare finish
- Fiber-optic light transmission provides cool, obstruction-free viewing
- 2.5V halogen illumination for true tissue color and long-lasting lamp performance
- Removable light pipe facilitates cleaning and service
- Color coded green to signify compatibility ONLY with fiber-optic handles

Ordering Information

Item	Blade	Description	Dim A	Dim B
4080F	0	Preemie	78 mm	53 mm
4081F	1	Infant	102 mm	77 mm
4082F	2	Child	155 mm	103 mm
4083F	3	Medium Adult	195 mm	170 mm
4084F	4	Large Adult	205 mm	180 mm



Fiberoptic Battery Handles

- Light source in handle simplifies blade cleaning, allows for use of brighter, whiter light
- Satin handles with a knurled finish for a positive grip
- Color coded green to signify compatibility ONLY with fiberoptic blades
- Available in traditional C, AA, and stubby (AA)
- Batteries not included

Ordering Information

Item	Description
4065F	Medium C-Size Fiberoptic Battery Handle
4066F	Small AA-Size Fiberoptic Battery Handle
4067F	Stubby AA-Size Fiberoptic Battery Handle
5111N-4	Fiberoptic Replacement Lamp, 1/Pkg



Fiber-optic and Standard Laryngoscope Sets

Choose from either a four-blade Macintosh or five-blade Miller set with both AA- and C-size battery handles.

- Four Macintosh or five Miller blades
- Both AA- and C-cell battery handles, batteries included
- Fitted case with carry handle



4079



4089F

Ordering Information

Item	Description
4079	Standard Set, Macintosh, includes one each: 1, 2, 3, 4 blades; AA handle (4066) & C handle (4065) in hard case
4089	Standard Set, Miller, includes one each: 0, 1, 2, 3, 4 blades; AA handle (4066) & C handle (4065) in hard case
4079F	Fiberoptic Set, Macintosh, includes one each: 1, 2, 3, 4 blades; AA handle (4066F) & C handle (4065F) in hard case
4089F	Fiberoptic Set, Miller, includes one each: 0, 1, 2, 3, 4 blades; AA handle (4066F) & C handle (4065F) in hard case



Laryngoscope Product Feature Chart

Model	Type	Size	Illumination Type	Quantity per Pkg	Overall Length	Blade Length	Handle	Battery	Lamp
4065	Handle	Medium	Standard	1	—	N/A	N/A	C x 2	N/A
4065F	Handle	Medium	Fiberoptic	1	—	N/A	N/A	C x 2	5111N-4
4066	Handle	Small	Standard	1	—	N/A	N/A	AA x 2	N/A
4066F	Handle	Small	Fiberoptic	1	—	N/A	N/A	AA x 2	5111N-4
4067	Handle	Stubby	Standard	1	—	N/A	N/A	AA x 2	N/A
4067F	Handle	Stubby	Fiberoptic	1	—	N/A	N/A	AA x 2	5111N-4
4070	Macintosh	0	Standard	1	80	58	4065, 66, 67	N/A	4500-1
4070F	Macintosh	0	Fiberoptic	1	80	55	4065F, 66F, 67F	N/A	N/A
4071	Macintosh	1	Standard	1	87	65	4065, 66, 67	N/A	4500-1
4071F	Macintosh	1	Fiberoptic	1	92	67	4065F, 66F, 67F	N/A	N/A
4072	Macintosh	2	Standard	1	108	86	4065, 66, 67	N/A	4500-1
4072F	Macintosh	2	Fiberoptic	1	108	83	4065F, 66F, 67F	N/A	N/A
4073	Macintosh	3	Standard	1	128	105	4065, 66, 67	N/A	4501-1
4073F	Macintosh	3	Fiberoptic	1	126	101	4065F, 66F, 67F	N/A	N/A
4074	Macintosh	4	Standard	1	159	137	4065, 66, 67	N/A	4501-1
4074F	Macintosh	4	Fiberoptic	1	155	134	4065F, 66F, 67F	N/A	N/A
4079	Kit	1-4	Standard	1	N/A	N/A	4065, 66, 67	N/A	N/A
4079F	Kit	1-4	Fiberoptic	1	N/A	N/A	4065F, 66F, 67F	N/A	5111N-4
4080	Miller	0	Standard	1	75	53	4065, 66, 67	N/A	4500-1
4080-0	Miller	00	Standard	1	65	43	4065, 66, 67	N/A	4500-1
4080F	Miller	0	Fiberoptic	1	78	53	4065F, 66F, 67F	N/A	N/A
4081	Miller	1	Standard	1	102	80	4065, 66, 67	N/A	4500-1
4081F	Miller	1	Fiberoptic	1	102	77	4065F, 66F, 67F	N/A	N/A
4082	Miller	2	Standard	1	155	133	4065, 66, 67	N/A	4501-1
4082F	Miller	2	Fiberoptic	1	155	103	4065F, 66F, 67F	N/A	N/A
4083	Miller	3	Standard	1	195	173	4065, 66, 67	N/A	4501-1
4083F	Miller	3	Fiberoptic	1	195	170	4065F, 66F, 67F	N/A	N/A
4084	Miller	4	Standard	1	205	183	4065, 66, 67	N/A	4501-1
4084F	Miller	4	Fiberoptic	1	205	180	4065F, 66F, 67F	N/A	N/A
4089	Kit	0-4	Standard	1	N/A	N/A	4065, 66, 67	N/A	4500-1/4501-1
4089F	Kit	0-4	Fiberoptic	1	N/A	N/A	4065F, 66F, 67F	N/A	5111N-4
4090	Wisconsin	0	Standard	1	77	55	4065, 66, 67	N/A	4500-1
4091	Wisconsin	1	Standard	1	102	80	4065, 66, 67	N/A	4500-1
40915	Wisconsin	1.5	Standard	1	115	93	4065, 66, 67	N/A	4500-1
4092	Wisconsin	2	Standard	1	135	112	4065, 66, 67	N/A	4501-1
4093	Wisconsin	3	Standard	1	162	139	4065, 66, 67	N/A	4501-1
4094	Wisconsin	4	Standard	1	199	177	4065, 66, 67	N/A	4501-1

CPR and Airways



- **Functional, easy-to-use tools for resuscitation**
- **Multiple packaging options for teaching or first-aid applications**
- **Solutions for pocket, purse, glove box, or trauma kits**

ADC's line of CPR products and resuscitation aids combine a tradition of innovation with a commitment to value. Products include:

Disposable Oral Airways for enhanced access to the respiratory tract. Our Berman style kit includes six sizes and two packaging options, polybag or translucent boxed case. Our Guedel style kit includes eight sizes in a translucent boxed case. Page 119.

Adsafe™ Face Shields and Valve Masks for safe and effective resuscitation. Face Shields help eliminate hesitation when performing CPR and can be purchased in sets of individual foil packs or packaged in convenient pocket keychains. The Adsafe CPR Pocket Resuscitator is a portable tool that's equipped with a high-efficiency one-way valve. Pages 119-120.

i ADC enjoys a reputation for building premium medical equipment that's equal parts durable and economical – one of the many reasons we're a favorite in the world of emergency medicine. Learn more at:

www.adctoday.com/solutions/EMS

Looking for the perfect case for all your first-aid gear? Check out our versatile and durable **1025 First Responder Trauma Bag**. Page 128.





Berman Disposable Airways

The Berman Oropharyngeal Airways feature

- Smooth polyethylene airway with reinforced bite block
- Color coded for easy identification
- Single use
- Non-sterile
- Six sizes, embossed in mm on airway
- Available in packages of 12 or 100 each in polybag or boxed set of six

Ordering Information

Item	Color Code	Description	Size
4000	All	Kit of 6 Sizes: 40-110 mm	00-6
4000P	All	Kit of 6 Sizes: 40-110 mm Packaged in Poly Bag	00-6



Guedel Disposable Airways

The Guedel Disposable Airways feature

- Smooth, flexible polyethylene airway with reinforced bite block
- Color coded for easy identification
- Single use
- Non-sterile
- Eight sizes, embossed in mm on airway

Ordering Information

Item	Color Code	Description	Size
43000	All	Kit of 8 Sizes: 40-110 mm	00-6



Bite Stick

The ADC Bite Stick features

- Depresses tongue and provides airway for seizure patients
- One piece
- Non-toxic
- Unbreakable
- Can be ETO sterilized
- Each packaged in a sanitary bag

Ordering Information

Item	Description
4010T	Bite Stick, 10 Pack



Adsafe™ CPR Face Shield Foil Ten Pack

- Offers the same features as the 4055 Adsafe™ CPR Face Shield, packaged in individual, single-use foil pouches - 10/pack

Ordering Information

Item	Description
------	-------------

4055-10	Adsafe™ CPR Face Shield Foil Pouch - 10/Pkg.
----------------	---



Adsafe™ CPR Face Shield

The Adsafe™ CPR Face Shield features

- User-friendly, single-use design protects the rescuer and helps eliminate hesitation when performing CPR
- Semi-transparent face shield allows visualization of patient's lips, mouth, and nose while protecting rescuer
- Printed instructions and orientation guide right on the shield help ensure correct use, even by those with little or no CPR experience
- Measures 8" W x 12" L when open, a miniscule 1 1/8" diameter in its case
- Comes in a compact, hard cylindrical case with handy key-ring clasp

Ordering Information

Item	Description
------	-------------

4055*	Adsafe™ CPR Face Shield with Case (specify color)
--------------	---

Color Choices

BK	OR	RB
-----------	-----------	-----------

NOTE: To ensure correct color choice when ordering, add color suffix to model number (e.g., 4055**RB**)



Adsafe™ PLUS CPR Face Shield

The Adsafe™ PLUS CPR Face Shield features

- User-friendly, single-use design protects the rescuer and helps eliminate hesitation when performing CPR
- Semi-transparent face shield allows visualization of patient's lips, mouth, and nose while protecting rescuer
- Printed instructions and orientation guide right on the shield help ensure correct use, even by those with little or no CPR experience
- Bite-block airway tunnel with extended mouthpiece assists the rescuer in maintaining an open airway when performing the head-tilt, chin-lift maneuver
- One-way valve with filter to protect the rescuer from victim's fluids
- Measures 6" L x 10" W when open, just 2" x 1 1/2" x 7/8" when in its case
- Includes compact, hard case with handy key-ring clasp

Ordering Information

Item	Description
------	-------------

4056*	Adsafe™ PLUS CPR Face Shield/ Case (specify color)
--------------	--

Color Choices

BK	OR	RB
-----------	-----------	-----------

NOTE: To ensure correct color choice when ordering, add color suffix to model number (e.g., 4056**RB**)





Adsafe™ CPR Pocket Resuscitator

The Adsafe™ CPR Pocket Resuscitator combines functionality with portability. Equipped with a filter-protected, replaceable one-way valve, it folds flat into a compact, splash-resistant clamshell storage case that measures just 5" x 4 1/8" x 1 1/2". Quick accessibility, dual invertible use, and standardized connection make this resuscitator an essential addition to your CPR equipment needs.

The Adsafe™ CPR Pocket Resuscitator features

- High-efficiency and low-resistance one-way valve minimizes the possibility of cross-contamination
- 15mm O.D. connector can be attached to any standard ventilation and oxygen equipment
- For use on adults, and can be inverted for infants/children
- Ergonomically shaped mask with soft-air cushion for leak-free performance, easy grasp, and patient comfort
- Disposable valve to avoid cross-contamination
- Elastic green strap to keep mask in place on patient
- Operating instructions, disposable gloves, and alcohol wipe included
- Pocket storage case



Ordering Information

Item	Description
4053	Adsafe™ CPR Pocket Resuscitator
4053V	Adsafe™ CPR Pocket Resuscitator, Valve Only
4053M	Adsafe™ CPR Pocket Resuscitator, Mask Only

 Customers purchasing in Canada can choose the 4053CN; gloves and alcohol wipe not included.



Protective Eyewear



New from
ADC!

ADC now offers protective eyewear!

Our line includes three styles of general-use, impact-resistant eyewear that's perfect for workplace visitors or student observation.

- **Item 5002BK** is a deluxe full-frame style with a lightweight design and adjustable temples and nose padding for a personalized fit.
- **Item 5001** is a full-frame style available in three colors, with length-adjustable temple arms and sculpted nose bridge for all-day comfort.
- **Item 5000** is a budget-priced style with wide-coverage lenses that fit over most prescription eyewear.

All styles meet the requirements of ANSI Z89.1 2020.

Models 5002 and 5001



UVA and UVB
Protection



1-Year
Warranty

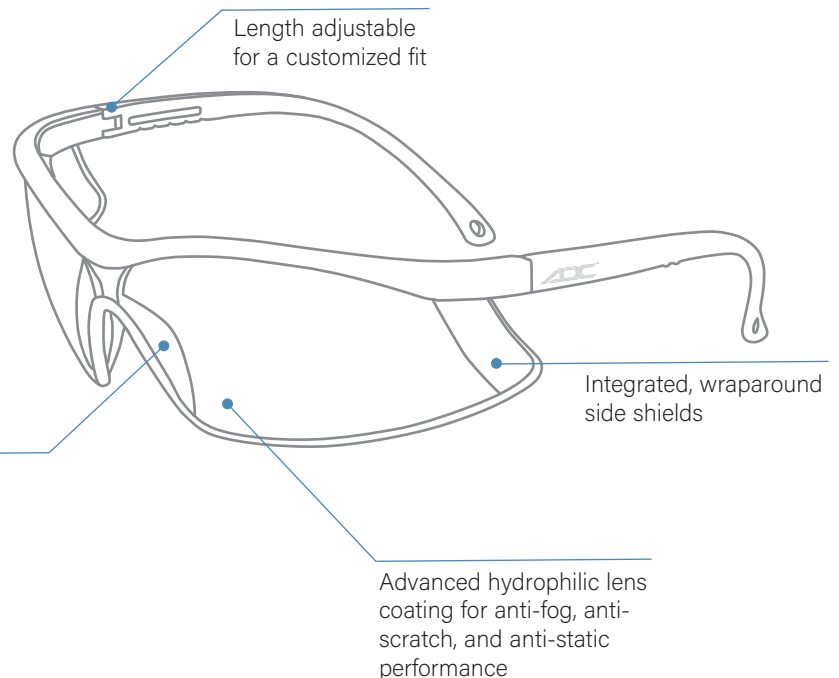

Deluxe Full-Frame Protective Eyewear

Create a personalized fit with adjustable temples and nose padding

- Stylish, lightweight design
- Length adjustable temple arms for a customized fit
- Soft, adjustable nose padding
- Integrated, wraparound side shields maximize coverage
- Advanced hydrophilic lens coating offers anti-fog, anti-scratch, and anti-static performance
- UVA and UVB protection
- Clear polycarbonate lens for unobstructed viewing
- Meets the requirements of ANSI Z89.1 2020

Ordering Information

Item	Description
5002BK	Deluxe Protective Eyewear, Black Frame w Blue Accents



Full-Frame Protective Eyewear

All-day comfort with length-adjustable temples and a sculpted nose bridge

- Length adjustable temple arms for a customized fit
- Sculpted nose bridge
- Integrated, wraparound side shields maximize coverage
- Advanced hydrophilic lens coating offers anti-fog, anti-scratch, and anti-static performance
- UVA and UVB protection
- Clear polycarbonate lens for unobstructed viewing
- Meets the requirements of ANSI Z89.1 2020

Ordering Information

Item	Description
5001*	Deluxe Protective Eyewear, Specify Color

Color Choices for **5001**

BK **N** **V**

NOTE: To ensure correct Tag color choice when ordering, add color suffix to model number (e.g., 5001**BK**)



Protective Student Eyewear

- 2.5 curve, 2.0mm lens
- 99.99% UV protection
- High-velocity impact and high mass resistant
- Lightweight temple design, weighs 36.8 g overall
- Wide coverage lens fits over most personal prescription eyewear
- Meets the requirements of ANSI Z87.1 and CE EN166

Ordering Information

Item	Description
5000	Protective Student Eyewear, Clear



Caseware



Organization is essential, whether you're a mid-career professional or a new student starting your first healthcare program. Whatever your need, ADC has a solution!

ADC offers an impressive selection of belt holsters, pocket organizers, medical bags, and other instrument cases, all designed with equal parts durability, form, and function.

- **Heavy-duty materials and construction that's built to last.**
- **Choose standalone holsters and organizers or complete kits with popular instrument combinations**
- **Versatile nylon medical bags with well-organized storage solutions**
- **Carrying cases perfectly sized for secure transport of aneroid and electronic sphygs.**



Zippers designed to last



420D or 600D nylon construction



Pouches, pleats, and pockets



Need a stethoscope case? We've got you covered!

Our MEDIC instrument cases safely hold a stethoscope or adult sphyg while securing an assortment of everyday tools and accessories. See Page 81 for more information.



Available in Navy, Dark Green, and Black



Nylon Medical Bag

A heavy-duty, padded medical nylon bag to protect your most valuable medical equipment.

The Medical Bag features

- Multiple pockets and heavy-duty nylon construction
- 8mm foam padded bottom
- Double-zipper opening for main compartment
- Two interior zippered pockets 6½" x 4"
- Adjustable, removable webbed shoulder strap and two contoured handles for easy carrying
- Eleven interior gusseted pockets of varying sizes
- Back file folder pocket 13¾" x 7"
- Front zippered pocket measures 7½" x 9½" x 2"
- Measures 14" x 9½" x 6" (closed)
- Weighs 1 lb. (453.6g)
- One-year warranty

Note: Items shown in photo are not included

Ordering Information

Item	Description
1024*	Medical Bag (specify color)

Colors Choices



NOTE: To ensure correct color when ordering, add color suffix to model number (e.g., 1024**DG**)



Rear file folder pocket



Eleven interior gusseted pockets



Adjustable, removable shoulder strap





ADC Trauma Bag

Incredibly durable, extraordinarily versatile medical trauma bag for the pre-hospital care professional.

The ADC Trauma Bag features

- Constructed of 600D nylon for rugged durability
- Flap top with snap-lock buckles permits rapid access
- Eighteen elastic interior tool holders and three spacious padded compartments
- Two zippered side pouches and dual front pleated pockets
- Adjustable, removable webbed shoulder strap and contoured handle
- Zippered storage within the top flap
- Measures 17½" x 9" x 9" (when full)
- Weighs 20 oz (567g)
- One-year warranty

Note: Items shown in photo are not included

Ordering Information

Item	Description
10250R	ADC Trauma Bag (Orange only)





Ordering Information

Item	Description
216*	Pocket Pal II™ Organizer (specify tag color)
116*	Pocket Pal II™ Organizer Kit (specify tag color)
117*	Pocket Pal III™ Organizer Kit (specify tag color - Black, Teal, Purple only)



216

Pocket Pal™ Organizer and Kits

An indispensable uniform accessory that combines fashionable storage and functional tools.

The 216 organizer features

- Washable 420D white nylon sewn with nylon thread
- Five slide-in and one covered pocket in front, one full-width slide-in pocket in rear
- Handy key ring
- Hook-and-loop snaps in choice of seven colors
- Measures 6¼" x 4¾" x 1/4", weighs 1 oz (28g)

The Pocket Pal II Kit (116) features the 216 organizer plus

- 5½" Lister bandage scissor (301)
- Three-color pen (392)
- Adlite™ disposable penlight (356W)

The Pocket Pal III Kit (117) features the 216 organizer plus

- MiniMedicut™ shear (321)
- Three-color pen (392)
- Adlite™ Plus disposable penlight (356)

Color Choices for **116 / 216** Only



Color Choices for **117** Only



NOTE: To ensure correct Tag color choice when ordering, add color suffix to model number (e.g., 116**RB**)



Nurse Combo

Pocket Pal II with a color-coordinated Adscope Sprague.

The Nurse Combo features

- The complete Pocket Pal II Kit (116, see above)
- Adscope 641 Sprague stethoscope (see page 71)

Ordering Information

Item	Description
116-641*Q	Nurse Combo (specify color)

Color Choices



NOTE: Frosted Scopes ONLY available with White Tags

NOTE: To ensure correct color when ordering, add color suffix to model number e.g., 116-641**DGQ**



Nurse Combo Plus

Pocket Pal III with a color-coordinated Adscope Sprague.

The Nurse Combo Plus features

- The complete Pocket Pal III Kit (117, see above)
- Adscope 641 Sprague stethoscope (see page 71)

Ordering Information

Item	Description
117-641*Q	Nurse Combo Plus (specify color)

Color Choices



NOTE: To ensure correct color when ordering, add color suffix to model number e.g., 117-641**TLQ**



Responder™ Holster

The world's best selling nylon holster, the 204 is made of super tough 600D nylon for unsurpassed durability.

The Responder™ features

- Super-tough, water-repellent 600D nylon
- Lined with 8mm of cushioning foam
- Conforming lightweight configuration for wearing comfort
- Sewn with heavy nylon thread for durability
- Snap-open belt loop reinforced with hook-and-loop adhesive
- Accommodates belts up to 2½" wide
- Two deep slide-in pockets in back
- Three slide-in pockets beneath covered flap in front
- Measures 7¼" x 5" x ½"
- Weighs 2 oz (57g)
- One-year warranty

The Responder™ Set features

- Responder™ holster (204BK)
- 5½" Kelly straight forceps (310)
- 7¼" Medicut™ shear (320B)
- Adlite™ disposable penlight (356W)
- 4½" Lister bandage scissor (300)
- Puma 2002™ (373)

Ordering Information

Item	Description
204BK	Responder™ Holster
104BKE	Responder™ Holster Set



Responder Jr.™ Holster

Our smallest, lightest, and most affordable nylon holster.

The Responder Jr.™ features

- Super-tough water-repellent 600D nylon
- Lined with 8mm of cushioning foam
- Sewn with heavy nylon thread for durability
- Snap-open belt loop reinforced with hook-and-loop adhesive
- One deep slide-in pocket in back
- Two half-width slide-in pockets in front
- Hook-and-loop restraining strap secures scissors
- Accommodates belts up to 2½"
- The 205 measures 7¼" x 2¾" x ½"
- The 215 measures 2¾" x 6" x ½"
- Weighs 1½ oz (42.5g)
- One-year warranty

The Responder Jr.™ Set features

- Responder Jr.™ holster (205BK or 215BK)
- 7¼" Medicut™ shear (320B)
- 5½" Kelly straight forceps (310)
- Adlite™ disposable penlight (356W)

Ordering Information

Item	Description
205BK	Responder Jr.™ Holster, Vertical
105BK	Responder Jr.™ Holster Set, Vertical
115BK	Responder Jr.™ Holster Set, Horizontal
215BK	Responder Jr.™ Holster, Horizontal





888



880 Series



887

Zipper Cases

- For all pocket, palm, and homecare models
- Traditional case (880) is available in three sizes
- Premium case (888) has one large zippered compartment, outside hook-and-loop pocket, end strap, and handy key ring (measures 9" x 5" x 2")

Ordering Information

Item	Description
880	Zipper Carry Case, Black
880M	Zipper Carry Case, Black, Medium
880L	Zipper Carry Case, Black, Extra Large
887	Fanny Pack, (Available in 4* Colors)
888	Premium Nylon Case (specify color)

Color Choices

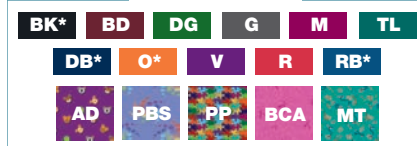

887 available in these Color Only



NOTE: To ensure correct color when ordering, add color suffix to model number (e.g., 888DG)



Multikuf™ Cases

- For the portable Multikuf™ systems
- Choose from three-, four-, and five-cuff carry cases
- Made of 600D nylon shell with 420D nylon lining, double zipper, and webbed handle

Ordering Information

Item	Description
8814BK	Pack for Multikuf™ 731 and 732
883B	Case for System 5™, Navy (not shown)
8830	Case for System 5™, Orange



8830



e-sphyg™ 3 Padded Carrying Case

- Heavy-duty nylon construction with padded interior
- Interior is sized for secure storage of e-sphyg 3, cuffs, and tubing
- Additional pouches and pockets offer storage for accessories
- Measures 15.5" W x 9" H x 4.75" D, weighs 1.5 lbs
- Made of 600D nylon shell with 420D nylon lining, double zipper, and webbed handle

Ordering Information

Item	Description
9003BAG	e-sphyg 3 Carrying Case



9003BAG

Neuro Instruments



One-year warranty



Inspected in the U.S.A.

Our Neurological Hammer Set includes five instruments in a deluxe fitted box.

Makes a great gift item!

See page 131.



ADC neurological instruments include the essentials professionals need to assess the peripheral and central nervous systems. Our line features six reflex instruments and six tuning forks.

Reflex instruments offer ergonomic designs constructed with high-quality materials like stainless steel, chrome, and non-latex, non-phthalate rubber.

Our selection includes:

- **Taylor Hammer**
- **Queen Square Hammer**
- **Buck Hammer**
- **Tromner Hammer**
- **Babinski Hammer**
- **Wartenberg Pinwheel**

Our tuning forks are machined from high-grade aluminum alloy and offer accurate frequency response in the most popular frequencies, from 128 to 4096 Hz.

Features of an Authentic ADC Tuning Fork



ADC tuning forks are machined in the USA from non-magnetic, corrosion-resistant aluminum alloy in 3/8" x 1" solid bar stock. Finished instruments do not bend, break, or deteriorate under normal use. The overall finish is a smooth satin aluminum.



ADC tuning forks are medical grade and accurate to .5% of their rated frequency response. Weights, which can be found on 128 Hz and 256 Hz instruments, are equally sized on each fork and are mounted securely about a quarter of an inch below the fork tips. The bottom of the fork handle is slightly beveled, with a small indent at the center.



ADC tuning forks are marked on both sides of the instrument. One side is stamped with the instrument frequency and the other is stamped ADC.



Tuning Forks

Aluminum alloy tuning forks designed and manufactured to meet the demanding needs of the medical profession.

The ADC Tuning Forks features

- Non-magnetic, corrosion resistant aluminum alloy construction
- Weighs $\frac{1}{3}$ of comparable steel tuning forks
- Produced from $\frac{3}{8}$ " x 1" bar stock for superior performance and consistent frequency accuracy
- Extra-long 2" handle of turned smooth aluminum to facilitate bone conduction tests
- Available in six frequency ranges (cycles per second, or cps)



Ordering Information

Item	Description	Frequency
500128	Tuning Fork with Fixed Weight	128cps
500256	Tuning Fork with Fixed Weight	256cps
500512	Tuning Fork without Fixed Weight	512cps
501024	Tuning Fork without Fixed Weight	1024cps
502048	Tuning Fork without Fixed Weight	2048cps
504096	Tuning Fork without Fixed Weight	4096cps





Neurological Hammer Set

Five of the most popular instruments for diagnosis of neurological function in one complete kit.

The ADC Neurological Hammer Set features

- Wartenberg Pinwheel (3695)
- Babinski Hammer (3697)
- Taylor Hammer (3693BK)
- Buck Hammer (3691)
- Queen Square Hammer (3699BK)
- Fitted case neatly stores all five instruments

Ordering Information

Item	Description
3600BK	Neuro Hammer Kit



Taylor Hammer

The ADC Taylor Hammer features

- The most popular neuro hammer
- Chrome handle with triangular synthetic rubber head in choice of five colors
- Overall length 7 1/2"

Ordering Information

Item	Description
3693	Taylor Neurological Hammer, Red
3693ST	Taylor Neurological Hammer, Tactical
3693BK	Taylor Neurological Hammer, Black
3693DG	Taylor Neurological Hammer, Dark Green
3693RB	Taylor Neurological Hammer, Royal Blue

Color Choices



NOTE: To ensure correct color when ordering, add color suffix to model number (e.g., 3693DG)



3693BK



3693ST



Buck Hammer

The ADC Buck Hammer features

- Chrome-plated handle with two-sided synthetic rubber head
- Handle conceals screw-in brush
- Needle contained within the head
- Overall length 7 1/2"

Ordering Information

Item	Description
3691	Buck Neurological Hammer



Babinski Hammer

The ADC Babinski Hammer features

- Hexagonal stainless-steel handle with concealed needle (3697) - Stainless steel telescoping handle (3698BK)
- Rubber head may be used in both the horizontal or vertical positions
- Overall length 8 1/2" (3697)
- Overall length 6 3/4" (3698BK)



3697



3698BK

Ordering Information

Item	Description
3697	Babinski Hammer
3698BK	Telescoping Babinski Hammer



3699BK

Queen Square Hammer

The ADC Queen Square Hammer features

- Rubber head
- Flexible handle
- Overall length 12 1/4"

Ordering Information

Item	Description
3699BK	Queen Square Hammer



Tromner Hammer

The ADC Tromner Hammer features

- Chrome-plated head with two silicone rubber mallets
- Large and small mallet ends for eliciting both tendon stretch reflexes and percussion myotonia
- Lightweight, ergonomic handle conceals screw-in brush
- Overall length 8 1/2"
- Not made with natural rubber latex



3694BK

Ordering Information

Item	Description
3694BK	Tromner Hammer



3695

Wartenberg Pinwheel

The ADC Wartenberg Pinwheel features

- Chrome-plated brass head, chrome-plated zinc handle
- Rotating spur
- Overall length 7 1/2"

Ordering Information

Item	Description
3695	Wartenberg Pinwheel



Diagnostic Penlights



Most models are available in a variety of colors and packaging options.

ADC Adlite™ and Metalite™ diagnostic penlights include reusable and disposable options at a full range of price points.

The **Adlite Pro** is our top-of-the line, super-premium reusable model. It's CNC machined from brass and features LED technology that's warranted for life. An innovative positive-feel power switch won't accidentally light when in your pocket.

Other reusable models include the **Metalite and Metalite II**, durable styles designed with aluminum housings, and the **Adlite II**, made with a plastic housing for lightweight comfort. All are incredibly economical solutions.

We also offer two disposable models, the **Adlite and Adlite Plus**. Featuring a sealed concentric beam, they provide a cost-effective solution to examining pupillary reflex.

Looking for a penlight with a pupil gauge?

Check out the Metalite, Metalite II, Adlite, and Adlite Plus.

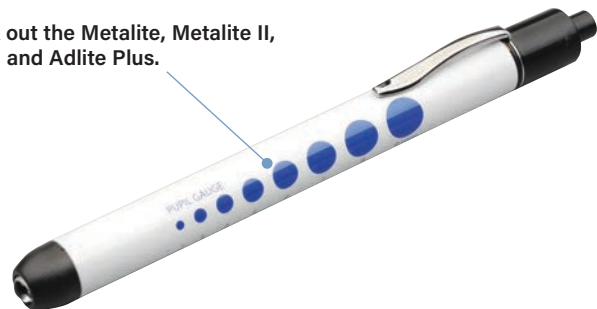



Positive Feel
Up/Down Switch
Activation

Adlite Pro™ 355BK

Our finest pocket light, the Adlite Pro™ is the physician's choice for evaluation of pupillary reflex.

The Adlite Pro™ features

- LED lamp for bright, white illumination for true tissue rendering
- LED lamp provides 10,000 hours of use eliminating the high cost of replacement lamps
- Durable CNC-machined brass housing in a striking black matte finish
- Measures 5 5/8" long, 1/2" diameter
- Positive feel power switch
- Convenient pocket clip
- Complete with two AAA batteries and an attractive gift box
- Lifetime warranty on LED lamp, two-year warranty on penlight

Ordering Information

Item	Description
355BK	Adlite Pro™ Physicians Penlight





Metalite™

A dependable reusable diagnostic penlight with aluminum body and plunger switch.

The Metalite™ 352 features

- Aluminum housing
- Locking push-toggle activated
- Measures 5 3/4" long by 1/2" diameter
- Available in four styles: black barrel, white barrel, white barrel with pupil gauge, and silver barrel
- Two AAA batteries included

Ordering Information

Item	Description
352BK	Metalite™ Penlight (Black Barrel)
352W	Metalite™ Penlight (White Barrel)
352WP	Metalite™ Penlight (White Barrel/Pupil Gauge)
352	Metalite™ Penlight (Silver Barrel)
352CYL	Metalite™ Penlight, 22/Cylinder (Silver Barrel)
352AST	Metalite™ Penlight, 22/Cylinder (Assort. Colors)



Metalite II™

Incredibly durable and reusable.

The Metalite II™ 353 features

- Aluminum housing for lightweight comfort
- LED lamp for bright white illumination
- Locking push-toggle activated
- Measures 5 1/4" long by 1/2" diameter
- Pupil gauges (all colors)
- Two AAA batteries included

Ordering Information

Item	Description
353BK	Metalite II™ Reusable Penlight (Black Barrel)
353R	Metalite II™ Reusable Penlight (Red Barrel)
353RB	Metalite II™ Reusable Penlight (Royal Blue Barrel)
353S	Metalite II™ Reusable Penlight (Silver Barrel)
353W	Metalite II™ Reusable Penlight (White Barrel)



Adlite II™

Incredibly durable and reusable.

The Adlite II™ 354 features

- Plastic housing for lightweight comfort
- Pocket-clip activated
- Measures 5" long by 1/2" diameter
- Two AAA batteries included

Ordering Information

Item	Description
354	Adlite II™ Reusable Penlight, White
354BK	Adlite II™ Reusable Penlight, Black
354CYL	Adlite II™ Reusable Penlight, 18/Cylinder



Adlite™

The Adlite™ 351 features

- Sealed concentric beam, disposable diagnostic penlight
- Activated by depressing the stainless-steel pocket clip
- Available with or without pupil gauge
- Measures 5" long, by ½" diameter
- Carbon zinc AAA battery (18-month lifespan)
- Sold in six pack

Ordering Information

Item	Description
351	Adlite™ Disposable Penlight, 6/pk
351P	Adlite™ Disposable Penlight w/Pupil Gauge, 6/pk



Adlite™ Plus

The Adlite™ Plus features

- Sealed concentric beam, disposable diagnostic penlight
- Activated by depressing the stainless-steel pocket clip
- Available with or without pupil gauge (white barrel)
- Measures 5" long, by ½" diameter
- Carbon zinc AAA battery (18-month lifespan)
- Sold individually or in display cylinder of 22
- Available in eight colors

Ordering Information

Item	Description
356*	Adlite™ Penlight, Specify Color
358AST	Adlite™ Penlight, Assorted Colors, 22/cyl
358TVB	Adlite™ Penlight (Black, Purple, Teal), 22/cyl
358W	Adlite™ Penlight (White), 22/cyl
358WP	Adlite™ Penlight, (White barrel/Pupil gauge), 22/cyl

Color Choices



NOTE: To ensure correct color when ordering, add color suffix to model number (e.g., 356**RB**)



Instruments



Precision crafted from the best materials in the world and backed by the industry's most comprehensive warranties

ADC's surgical instruments and accessories are designed and manufactured to our exacting specifications to withstand the rigors of daily use. Our line has been carefully curated to include a wide selection of the most popular tools, covering a variety of practical applications. From scissors and hemostats crafted from surgical stainless steel to our Medicut® brand nursing and EMS shears, we have the products professionals need to get the job done.

- **Bandage and operating scissors and multiple styles and sizes of forceps**
- **Emergency tools like our Puma folding pocket knife and finger ring cutter**
- **Specialty and general-use measurement tools**

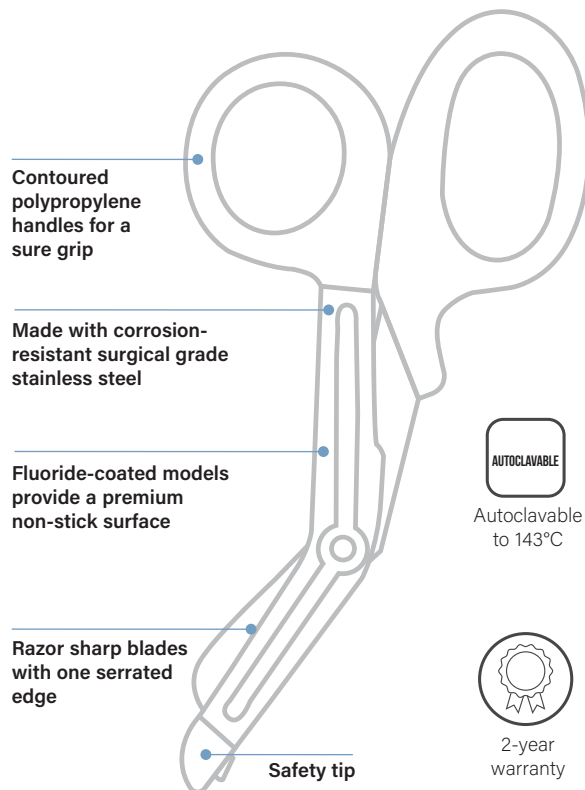

MEDICUT®

ADC's Medicut shears, along with our smaller-scale MiniMedicut styles, are the best-selling brand of medical grade utility shears in the world.



New non-stick fluoride finish



See color chart for fluoride options

321TDFPB



321CHBK

321WTFPL



321PP



321BCA



321AD

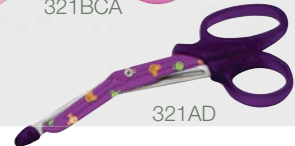

Medicut® Shears

Available in two sizes, ADC's Medicut® shears are the world's best selling brand of medical grade utility shears.

Medicut Shears feature

- Razor sharp, super-hardened surgical stainless-steel blades with one serrated edge to cut through the toughest materials
- Blades tempered to a Rockwell hardness of C56 for unsurpassed durability
- Fluoride-coated models provide a premium non-stick surface ideal for cutting through sticky materials like tape and bandages.
- Contoured polypropylene handles with large ring provide maximum control and comfort
- Extra-large rivet with a rated strength of 88kg assures rugged durability
- Autoclaved at 143°C (290°F)
- Available in traditional 7¼", or smaller 5½" length
- Inspected in the USA
- Two-year quality performance guarantee

Medicut Shears also include

- Traditional 7¼" length for maximum leverage and strength
- Stainless-steel safety bandage tip

MiniMedicut Shears also include

- Smaller 5" length is ideal for cutting bandages, tape, and clothing
- Polypropylene safety bandage tip color coordinated to the handle

Ordering Information

Item	Description
320**	Medicut 7¼" Shears, Specify Color
321**	MiniMedicut 5½" Shears, Specify Color

Color Choices for 320 Only

BK	BD	B	DG	NO	NP	
NY	R	RB	ST	TL	V	W
Fluoride Color Choices						
TBK	TNY					

Color Choices for 321 Only

BK	B	DG	FI	FM	FPB	FPL
FKW	M	R	RB	ST	TL	V
Fluoride Color Choices						
TBK	TV	TV				
Handle/Blade Prints						
AD	BCA	CHBK	PP			
	TDFPB	WTFPL				

NOTE: To ensure correct color when ordering, add color suffix to model number (e.g., 320R)



Surgical Instruments

Forged from corrosion-resistant surgical-stainless steel, these popular floor-grade instruments are built to last.



Scissors

Ordering Information

Item	Description	Size	Photo
300	Lister Bandage Scissors	4½"	B
301	Lister Bandage Scissors	5½"	B
302	Lister Bandage Scissors	7½"	B
3006	Lister Bandage Scissors with Clip	4½"	D
3007	Lister Bandage Scissors with Clip	5½"	D
3000G	Lister Bandage Scissors, Gold	4½"	C
3010G	Lister Bandage Scissors with Clip, Gold	5½"	C
323*	Listerette Scissors (Specify Color)	5½"	A
3410	Mayo Dissecting Scissors, Straight	5½"	G
3404SS	Operating Scissors, Straight, S/S	5½"	H
3404SB	Operating Scissors, Straight, S/B	5½"	N
3424	Iris Scissors, Straight	4½"	F
3425	Iris Scissors, Curved	4½"	E
3656	Umbilical Cord Scissors	4"	J
308	Littauer Stitch Scissors	5½"	O

Color Choices



NOTE: To ensure correct color when ordering, add color suffix to model number (e.g., 323RB)



Thumb Dressing / Plain Splinter Forceps

Item	Description	Size	Photo
330	Thumb Dressing Forceps	5"	Q
3328	Plain Splinter Forceps	3½"	P
332	Plain Splinter Forceps	4½"	P
3319	Adson Tissue Forceps, Serrated	4½"	R

Hemostatic Forceps

Item	Description	Size	Photo
314	Halstead Mosquito Forceps, Straight	5"	M
3141	Halstead Mosquito Forceps, Curved	5"	L
310	Kelly Forceps, Straight	5½"	M
311	Kelly Forceps, Curved	5½"	L
312	Kelly Forceps, Straight	6¼"	M
313	Kelly Forceps, Curved	6¼"	L
3101	Crile Forceps, Straight	5½"	M
3102	Crile Forceps, Curved	5½"	L

Magill Catheter / Tongue Forceps

Item	Description	Size	Photo
315	Magill Catheter Forceps, Child	8"	I
316	Magill Catheter Forceps, Adult	9¼"	I
317	Young Tongue Seizing Forceps, Child	6½"	K

Puma 2002™

A lightweight pocket knife with thumb activated blade and integral clip.

- 4½" razor-sharp serrated blade cuts through the toughest materials
- Thumb-activated speed blade allows convenient one-handed use
- Lock-back design for safety
- Ultra-lightweight, yet incredibly strong nylon fiber handle withstands the toughest use
- Integral pocket clip
- Open length 8¾", closed 4¾"
- Weighs 1 oz (28g)
- Lifetime warranty

Ordering Information

Item

Description

373

Puma 2002™



Finger Ring Cutter

- Chrome handle
- Safety lever slides protective plate between finger and ring
- Large thumbscrew operates a razor-sharp serrated saw

Ordering Information

Item

Description

380

Finger Ring Cutter

381

Finger Ring Cutter Replacement Blade



Woven Tape Measure

- Tape enclosed in compact container
- Measures in inches and centimeters (60"/150cm)
- Push button in back to rewind tape

Ordering Information

Item

Description

396

Woven Tape Measure





EKG Ruler / Caliper

Two popular electrocardiograph accessories.

The EKG Ruler features

- Seconds scale for PR, QRS, Cycle, Length, Coupling, Escape, and Parasystolic Intervals
- Measures just 1 1/16" x 6 3/8", small enough to fit in a medical coat pocket
- 1- and 2-cycle scales
- Complete with protective sleeve

The EKG Caliper features

- Hardened steel arms and points for accurate measurement of tracing intervals
- Point protector has built-in 40mm metric scale
- Measure 4 3/4"

Ordering Information

Item	Description
394	EKG Ruler
395	EKG Caliper



Goniometers

8-Inch and 12-Inch Multi-Use Goniometer feature:

- 360-degree head with two (8-inch) or three (12-inch) calibrated scales, reads in 1-degree increments
- Arm with linear scale in both inches and centimeters
- Remains in measurement position until reset
- 1-year warranty

Ordering Information

Item	Description
39712	12-Inch Goniometer
39708	8-Inch Goniometer

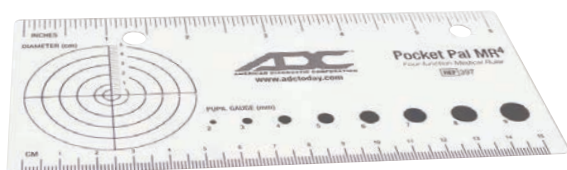
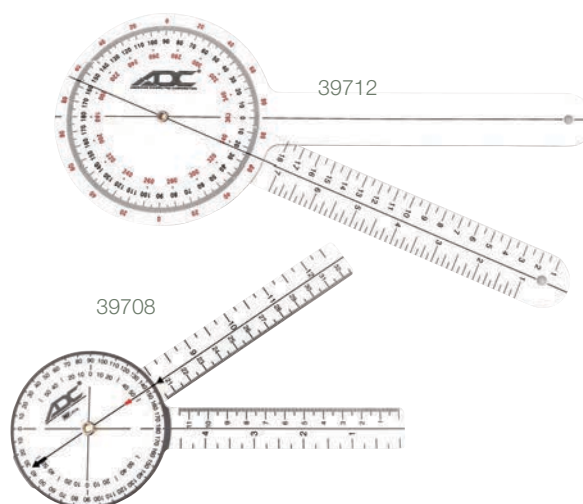

Pocket Pal MR4

Four-Function Pocket Medical Ruler

Pocket-size medical reference ruler features:

- Dual scale in both inches and centimeters
- Features imprinted pupil dilation and wound diameter gauges
- Made from heavy-duty clear plastic for durability
- Overall size 7.5" x 3"

Ordering Information

Item	Description
397	Four-Function Pocket Medical Ruler



Product Number Index

To locate a product when only its ADC product number is known, look up the product number (the index is in ascending model # sequence) and refer to the page number where the product is

illustrated. "N/A" indicates the product is not illustrated in our catalog. Refer to the contents, page 3, if either the product type or category is known (i.e., stethoscopes, scissors, etc.)

ADC Item	Cat. Page	ADC Item	Cat. Page	ADC Item	Cat. Page	ADC Item	Cat. Page	ADC Item	Cat. Page
HPF-S-MQF	48	21000R	9	320NO	138	3404SS	139	380	140
HPF-S-N	48	2150	10	320NP	138	3410	139	381	140
HPF-S-SCM	48	215BK	127	320NY	138	3424	139	392-12	N/A
SCF2-Y-HPM	48	216BK	127	320R	138	3425	139	394	141
SCF2-Y-MQF	48	216DG	127	320RB	138	351	136	395	141
SCF2-Y-N	48	216N	127	320ST	138	351P	136	396	140
SCF-S2-HPM	48	216RB	127	320TBK	138	352	135	397	141
SCF-S2-MQF	48	216TL	127	320TL	138	352AST	135	39708	141
SCF-S2-N	48	216V	127	320TNY	138	352BK	135	39712	141
1024BK	124	216W	127	320V	138	352CYL	135	4000	118
1024DG	124	217BK	83	320W	138	352W	135	4000P	118
1024N	124	218BK	83	321AD	138	352WP	135	4010T	118
10250R	125	218RB	83	321B	138	353BK	135	4053	120
1028LBK	82	218V	83	321BCA	138	353R	135	4053M	120
1028SBK	82	218W	83	321BK	138	353RB	135	4053V	120
104BKE	127	219BK	84	321CHBK	138	353S	135	4055-10	119
105BK	127	219NGR	84	321DG	138	353W	135	4055BK	119
115BK	127	219P	84	321FI	138	354	135	40550R	119
116-641BKQ	126	219R	84	321FKW	138	354BK	135	4055RB	119
116-641DGQ	126	219RB	84	321FM	138	354CYL	135	4056BK	119
116-641FKWQ	126	219V	84	321FPB	138	355BK	134	40560R	119
116-641FMQ	126	219W	84	321FPL	138	356BK	136	4056RB	119
116-641FPBQ	126	2200	10	321M	138	3560R	136	4065	114
116-641FPLQ	126	300	139	321PP	138	356R	136	4065F	115
116-641NQ	126	3000G	139	321R	138	356RB	136	4066	114
116-641RBQ	126	3006	139	321RB	138	356TL	136	4066F	115
116-641TLQ	126	3007	139	321ST	138	356V	136	4067	114
116-641VQ	126	301	139	321TBK	138	356W	136	4067F	115
116BK	126	3010G	139	321TDFPB	138	356WP	136	4070	114
116DG	126	302	139	321TL	138	358AST	136	4070F	115
116N	126	308	139	321TRB	138	358TVB	136	4071	114
116RB	126	310	139	321TV	138	358W	136	4071F	115
116TL	126	3101	139	321V	138	358WP	136	4072	114
116V	126	3102	139	321WTFPL	138	3600BK	131	4072F	115
116W	126	311	139	323BD	139	3656	139	4073	114
117-641BKQ	126	312	139	323BK	139	3691	131	4073F	115
117-641TLQ	126	313	139	323DG	139	3693	131	4074	114
117-641VQ	126	314	139	323M	139	3693BK	131	4074F	115
117BK	126	3141	139	323N	139	3693DG	131	4079	116
117TL	126	315	139	323RB	139	3693RB	131	4079F	116
117V	126	316	139	323TL	139	3693ST	131	4080	114
204BK	127	317	139	323V	139	3694BK	132	4080-0	114
205BK	127	320B	138	330	139	3695	132	4080F	115
2100	9	320BD	138	3319	139	3697	132	4081	114
2100-1	9	320BK	138	332	139	3698BK	132	4081F	115
2100-2BK	9	320BKE	138	3328	139	3699BK	132	4082	114
2100-20R	9	320DG	138	3404SB	139	373	140	4082F	115

ADC Item	Cat. Page	ADC Item	Cat. Page	ADC Item	Cat. Page	ADC Item	Cat. Page	ADC Item	Cat. Page
4083	114	4523-1	107	5111NLRB	105	5120NLV	105	5312-3	100
4083F	115	5000	122	5111NLS	105	5120NRB	105	5312-4	N/A
4084	114	500128	130	5111NLSBD	105	5120NV	105	5312-ZC	N/A
4084F	115	5001BK	122	5111NLSG	105	5121N	N/A	54102A	104
4089	116	5001N	122	5111NLSGR	105	5122N	N/A	54102AS	104
4089F	116	5001V	122	5111NLSRB	105	5140N	105	54102B	104
4090	114	500256	130	5111NLSV	105	5140NBD	105	54102BS	104
4091	114	5002BK	122	5111NLV	105	5140NG	105	54102L	104
40915	114	500512	130	5111NRB	105	5140NGR	105	54102LS	104
4092	114	501024	130	5111NS	105	5140NL	105	54102X	104
4093	114	502048	130	5111NSBD	105	5140NLBD	105	54102XS	104
4094	114	504096	130	5111NSG	105	5140NLG	105	5410A	104
412-00	93	5110E	105	5111NSGR	105	5140NLGR	105	5410AS	104
412K	94	5110EBD	105	5111NSRB	105	5140NLRB	105	5410B	104
413B	93	5110EG	105	5111NSV	105	5140NLV	105	5410BS	104
413B-00	93	5110EGR	105	5111NV	105	5140NRB	105	5410L	104
413BK	93	5110ERB	105	5112N	105	5140NV	105	5410LS	104
413R	93	5110EV	105	5112N-4	107	5160N	102	5410X	104
413R-00	93	5110N	105	5112NBD	105	5160NBD	105	5410XS	104
413RK	94	5110NBD	105	5112NG	105	5160NG	105	5410-ZC	N/A
415FL	92	5110NG	105	5112NGR	105	5160NGR	105	5411-4L	N/A
415K	94	5110NGR	105	5112NL	105	5160NRB	105	5411-4X	N/A
416-100	94	5110NL	105	5112NL-4	105	5160NV	105	5411-AD	N/A
416-1000	94	5110NLBD	105	5112NLBD	105	5210	106	5411L	104
416-50	94	5110NLG	105	5112NLG	105	5210-4	107	5411X	104
418N	92	5110NLGR	105	5112NLGR	105	5210-ZC	N/A	54122L	104
419	90	5110NLRB	105	5112NLRB	105	5211	102	54122X	104
421	89	5110NLS	105	5112NLS	105	5211-4	107	5412-4L	N/A
422	90	5110NLSBD	105	5112NLSBD	105	5211-5	102	5412-4X	N/A
424	89	5110NLSG	105	5112NLSG	105	5211-6	N/A	5412L	104
425-40	89	5110NLSGR	105	5112NLSGR	105	5211-7	N/A	5412X	104
426F	92	5110NLSRB	105	5112NLSRB	105	5211-8	N/A	5413	104
427	91	5110NLSV	105	5112NLSV	105	5211-9	N/A	5416L	104
427Q	91	5110NLV	105	5112NLV	105	5211-AD	N/A	5416X	104
429	86	5110NRB	105	5112NRB	105	5211-L	N/A	5420L	98
429CRADLE	86	5110NS	105	5112NS	105	5211V	N/A	5420X	98
43000	118	5110NSBD	105	5112NSBD	105	5212	106	5422L	98
432	87	5110NSG	105	5112NSG	105	5215	106	5422X	98
432LANYRB	87	5110NSGR	105	5112NSGR	105	5215-M3	N/A	5426L	100
433	88	5110NSRB	105	5112NSRB	105	5215-M4	N/A	5426X	100
4500-1	107	5110NSV	105	5112NSV	105	5215-NS	N/A	543102A	104
4501-1	107	5110NV	105	5112NV	105	5215-TD	N/A	543102AS	104
4502-1	107	5111N	105	5120N	105	5215-TH	N/A	543102B	104
4504-1	107	5111N-4	107	5120NBD	105	5215-TO	N/A	543102BS	104
4504A-1	107	5111NBD	105	5120NG	105	5215-ZC	N/A	543102L	104
4507-1	107	5111NG	105	5120NGR	105	5220	98	543102LS	104
4513-1	107	5111NGR	105	5120NL	105	5240	99	543102X	104
4514-1	107	5111NL	105	5120NLBD	105	5260	102	543102XS	104
4516-1	107	5111NLBD	105	5120NLG	105	5312	100	54310A	104
4518-1	107	5111NLG	105	5120NLGR	105	5312-1	N/A	54310B	104
4522-1	107	5111NLGR	105	5120NLRB	105	5312-2	N/A	54310BS	104

ADC Item	Cat. Page	ADC Item	Cat. Page	ADC Item	Cat. Page	ADC Item	Cat. Page	ADC Item	Cat. Page
54310L	104	5480AS	104	56102A-57	112	56102L-5	112	5610A-38W	112
54310LS	104	5480B	104	56102A-6L	112	56102L-56L	112	5610A-39W	112
54310X	104	5480BS	104	56102A-6L7	112	56102L-56X	112	5610A-3W	112
54310XS	104	5480L	104	56102A-6X	112	56102L-57	112	5610A-5	112
54311L	104	5480LS	104	56102A-6X7	112	56102L-6L	112	5610A-56L	112
54311X	104	5480X	104	56102A-7	112	56102L-6L7	112	5610A-56X	112
543122L	104	5480XS	104	56102B	112	56102L-6X	112	5610A-57	112
543122X	104	5481L	104	56102B-3	112	56102L-6X7	112	5610A-6L	112
54312L	104	5481X	104	56102B-347W	112	56102L-7	112	5610A-6L7	112
54312X	104	5500	101	56102B-348W	112	56102X	112	5610A-6X	112
54313	104	55102A	103	56102B-349W	112	56102X-3	112	5610A-6X7	112
54316L	104	55102B	103	56102B-35	112	56102X-347W	112	5610A-7	112
54316X	104	55102L	103	56102B-356L	112	56102X-348W	112	5610B	112
543802A	104	55102X	103	56102B-356X	112	56102X-349W	112	5610B-3	112
543802AS	104	5510A	103	56102B-357	112	56102X-35	112	5610B-347W	112
543802B	104	5510B	103	56102B-36L	112	56102X-356L	112	5610B-348W	112
543802BS	104	5510L	103	56102B-36L7	112	56102X-356X	112	5610B-349W	112
543802L	104	5510X	103	56102B-36X	112	56102X-357	112	5610B-35	112
543802LS	104	5560	101	56102B-36X7	112	56102X-36L	112	5610B-356L	112
543802X	104	5560BAT	101	56102B-37	112	56102X-36L7	112	5610B-356X	112
543802XS	104	55802A	103	56102B-37W	112	56102X-36X	112	5610B-357	112
54380A	104	55802B	103	56102B-38W	112	56102X-36X7	112	5610B-36L	112
54380AS	104	55802L	103	56102B-39W	112	56102X-37	112	5610B-36L7	112
54380B	104	55802X	103	56102B-3W	112	56102X-37W	112	5610B-36X	112
54380BS	104	5580A	103	56102B-5	112	56102X-38W	112	5610B-36X7	112
54380L	104	5580B	103	56102B-56L	112	56102X-39W	112	5610B-37	112
54380LS	104	5580L	103	56102B-56X	112	56102X-3W	112	5610B-37W	112
54380X	104	5580X	103	56102B-57	112	56102X-5	112	5610B-38W	112
54380XS	104	5600S	112	56102B-6L	112	56102X-56L	112	5610B-39W	112
54381L	104	5602	112	56102B-6L7	112	56102X-56X	112	5610B-3W	112
54381X	104	56102A	112	56102B-6X	112	56102X-57	112	5610B-5	112
5440L	99	56102A-3	112	56102B-6X7	112	56102X-6L	112	5610B-56L	112
5440X	99	56102A-347W	112	56102B-7	112	56102X-6L7	112	5610B-56X	112
5442L	99	56102A-348W	112	56102L	112	56102X-6X	112	5610B-57	112
5442X	99	56102A-349W	112	56102L-3	112	56102X-6X7	112	5610B-6L	112
5450	100	56102A-35	112	56102L-347W	112	56102X-7	112	5610B-6L7	112
5460	101	56102A-356L	112	56102L-348W	112	5610A	112	5610B-6X	112
5460BAT	101	56102A-356X	112	56102L-349W	112	5610A-3	112	5610B-6X7	112
5463	101	56102A-357	112	56102L-35	112	5610A-347W	112	5610B-7	112
5463ADAPT	101	56102A-36L	112	56102L-356L	112	5610A-348W	112	5610L	112
5463BAT	101	56102A-36L7	112	56102L-356X	112	5610A-349W	112	5610L-3	112
5463USBCBL	101	56102A-36X	112	56102L-357	112	5610A-35	112	5610L-347W	112
54802A	104	56102A-36X7	112	56102L-36L	112	5610A-356L	112	5610L-348W	112
54802AS	104	56102A-37	112	56102L-36L7	112	5610A-356X	112	5610L-349W	112
54802B	104	56102A-37W	112	56102L-36X	112	5610A-357	112	5610L-35	112
54802BS	104	56102A-38W	112	56102L-36X7	112	5610A-36L	112	5610L-356L	112
54802L	104	56102A-39W	112	56102L-37	112	5610A-36L7	112	5610L-356X	112
54802LS	104	56102A-3W	112	56102L-37W	112	5610A-36X	112	5610L-357	112
54802X	104	56102A-5	112	56102L-38W	112	5610A-36X7	112	5610L-36L	112
54802XS	104	56102A-56L	112	56102L-39W	112	5610A-37	112	5610L-36L7	112
5480A	104	56102A-56X	112	56102L-3W	112	5610A-37W	112	5610L-36X	112

ADC Item	Cat. Page	ADC Item	Cat. Page	ADC Item	Cat. Page	ADC Item	Cat. Page	ADC Item	Cat. Page
5610L-36X7	112	5611L-346X8W	112	5611X-36L	112	5612L-7	112	56802A-6L7	112
5610L-37	112	5611L-346X9W	112	5611X-36L7	112	5612X	112	56802A-6X	112
5610L-37W	112	5611L-35	112	5611X-36L7W	112	5612X-5	112	56802A-6X7	112
5610L-38W	112	5611L-356L	112	5611X-36L8W	112	5612X-56L	112	56802A-7	112
5610L-39W	112	5611L-356X	112	5611X-36L9W	112	5612X-56X	112	56802B	112
5610L-3W	112	5611L-357	112	5611X-36LW	112	5612X-57	112	56802B-3	112
5610L-5	112	5611L-357W	112	5611X-36X	112	5612X-6L	112	56802B-347W	112
5610L-56L	112	5611L-358W	112	5611X-36X7	112	5612X-6L7	112	56802B-348W	112
5610L-56X	112	5611L-359W	112	5611X-36X7W	112	5612X-6X	112	56802B-349W	112
5610L-57	112	5611L-35W	112	5611X-36X8W	112	5612X-6X7	112	56802B-35	112
5610L-6L	112	5611L-36L	112	5611X-36X9W	112	5612X-7	112	56802B-356L	112
5610L-6L7	112	5611L-36L7	112	5611X-36XW	112	5613	112	56802B-356X	112
5610L-6X	112	5611L-36L7W	112	5611X-37	112	5613-6L	112	56802B-357	112
5610L-6X7	112	5611L-36L8W	112	5611X-5	112	5613-6L7	112	56802B-36L	112
5610L-7	112	5611L-36L9W	112	5611X-56L	112	5613-6X	112	56802B-36L7	112
5610X	112	5611L-36LW	112	5611X-56X	112	5613-6X7	112	56802B-36X	112
5610X-3	112	5611L-36X	112	5611X-57	112	5613-7	112	56802B-36X7	112
5610X-347W	112	5611L-36X7	112	5611X-6L	112	5616L	112	56802B-37	112
5610X-348W	112	5611L-36X7W	112	5611X-6L7	112	5616L	112	56802B-37W	112
5610X-349W	112	5611L-36X8W	112	5611X-6X	112	5616L-7	112	56802B-38W	112
5610X-35	112	5611L-36X9W	112	5611X-6X7	112	5616X	112	56802B-39W	112
5610X-356L	112	5611L-36XW	112	5611X-7	112	5616X	112	56802B-3W	112
5610X-356X	112	5611L-37	112	56122L	112	5616X-7	112	56802B-5	112
5610X-357	112	5611L-5	112	56122L-5	112	5630	112	56802B-56L	112
5610X-36L	112	5611L-56L	112	56122L-56L	112	5660E	112	56802B-56X	112
5610X-36L7	112	5611L-56X	112	56122L-56X	112	5660T	112	56802B-57	112
5610X-36X	112	5611L-57	112	56122L-57	112	5660TE	112	56802B-6L	112
5610X-36X7	112	5611L-6L	112	56122L-6L	112	5660TN-GAK	102	56802B-6L7	112
5610X-37	112	5611L-6L7	112	56122L-6L7	112	56802A	112	56802B-6X	112
5610X-37W	112	5611L-6X	112	56122L-6X	112	56802A-3	112	56802B-6X7	112
5610X-38W	112	5611L-6X7	112	56122L-6X7	112	56802A-347W	112	56802B-7	112
5610X-39W	112	5611L-7	112	56122L-7	112	56802A-348W	112	56802L	112
5610X-3W	112	5611X	112	56122X	112	56802A-349W	112	56802L-3	112
5610X-5	112	5611X-3	112	56122X-5	112	56802A-35	112	56802L-347W	112
5610X-56L	112	5611X-3457W	112	56122X-56L	112	56802A-356L	112	56802L-348W	112
5610X-56X	112	5611X-3458W	112	56122X-56X	112	56802A-356X	112	56802L-349W	112
5610X-57	112	5611X-3459W	112	56122X-57	112	56802A-357	112	56802L-35	112
5610X-6L	112	5611X-346L7W	112	56122X-6L	112	56802A-36L	112	56802L-356L	112
5610X-6L7	112	5611X-346L8W	112	56122X-6L7	112	56802A-36L7	112	56802L-356X	112
5610X-6X	112	5611X-346L9W	112	56122X-6X	112	56802A-36X	112	56802L-357	112
5610X-6X7	112	5611X-346X7W	112	56122X-6X7	112	56802A-36X7	112	56802L-36L	112
5610X-7	112	5611X-346X8W	112	56122X-7	112	56802A-37	112	56802L-36L7	112
5611L	112	5611X-346X9W	112	5612L	112	56802A-37W	112	56802L-36X	112
5611L-3	112	5611X-35	112	5612L-5	112	56802A-38W	112	56802L-36X7	112
5611L-3457W	112	5611X-356L	112	5612L-56L	112	56802A-39W	112	56802L-37	112
5611L-3458W	112	5611X-356X	112	5612L-56X	112	56802A-3W	112	56802L-37W	112
5611L-3459W	112	5611X-357	112	5612L-57	112	56802A-5	112	56802L-38W	112
5611L-346L7W	112	5611X-357W	112	5612L-6L	112	56802A-56L	112	56802L-39W	112
5611L-346L8W	112	5611X-358W	112	5612L-6L7	112	56802A-56X	112	56802L-3W	112
5611L-346L9W	112	5611X-359W	112	5612L-6X	112	56802A-57	112	56802L-5	112
5611L-346X7W	112	5611X-35W	112	5612L-6X7	112	56802A-6L	112	56802L-56L	112

ADC Item	Cat. Page	ADC Item	Cat. Page	ADC Item	Cat. Page	ADC Item	Cat. Page	ADC Item	Cat. Page
56802L-56X	112	5680A-3W	112	5680L-37W	112	5681L-35	112	5681X-36L7W	112
56802L-57	112	5680A-5	112	5680L-38W	112	5681L-356L	112	5681X-36L8W	112
56802L-6L	112	5680A-56L	112	5680L-39W	112	5681L-356X	112	5681X-36L9W	112
56802L-6L7	112	5680A-56X	112	5680L-3W	112	5681L-357	112	5681X-36LW	112
56802L-6X	112	5680A-57	112	5680L-5	112	5681L-357W	112	5681X-36X	112
56802L-6X7	112	5680A-6L	112	5680L-56L	112	5681L-358W	112	5681X-36X7	112
56802L-7	112	5680A-6L7	112	5680L-56X	112	5681L-359W	112	5681X-36X7W	112
56802X	112	5680A-6X	112	5680L-57	112	5681L-35W	112	5681X-36X8W	112
56802X-3	112	5680A-6X7	112	5680L-6L	112	5681L-36L	112	5681X-36X9W	112
56802X-347W	112	5680A-7	112	5680L-6L7	112	5681L-36L7	112	5681X-36XW	112
56802X-348W	112	5680B	112	5680L-6X	112	5681L-36L7W	112	5681X-37	112
56802X-349W	112	5680B-3	112	5680L-6X7	112	5681L-36L8W	112	5681X-5	112
56802X-35	112	5680B-347W	112	5680L-7	112	5681L-36L9W	112	5681X-56L	112
56802X-356L	112	5680B-348W	112	5680X	112	5681L-36LW	112	5681X-56X	112
56802X-356X	112	5680B-349W	112	5680X-3	112	5681L-36X	112	5681X-57	112
56802X-357	112	5680B-35	112	5680X-347W	112	5681L-36X7	112	5681X-6L	112
56802X-36L	112	5680B-356L	112	5680X-348W	112	5681L-36X7W	112	5681X-6L7	112
56802X-36L7	112	5680B-356X	112	5680X-349W	112	5681L-36X8W	112	5681X-6X	112
56802X-36X	112	5680B-357	112	5680X-35	112	5681L-36X9W	112	5681X-6X7	112
56802X-36X7	112	5680B-36L	112	5680X-356L	112	5681L-36XW	112	5681X-7	112
56802X-37	112	5680B-36L7	112	5680X-356X	112	5681L-37	112	6005	40
56802X-37W	112	5680B-36X	112	5680X-357	112	5681L-5	112	600BD	55
56802X-38W	112	5680B-36X7	112	5680X-36L	112	5681L-56L	112	600BK	55
56802X-39W	112	5680B-37	112	5680X-36L7	112	5681L-56X	112	600DG	55
56802X-3W	112	5680B-37W	112	5680X-36X	112	5681L-57	112	600GP	55
56802X-5	112	5680B-38W	112	5680X-36X7	112	5681L-6L	112	600IMCA	55
56802X-56L	112	5680B-39W	112	5680X-37	112	5681L-6L7	112	600IST	55
56802X-56X	112	5680B-3W	112	5680X-37W	112	5681L-6X	112	600MCA	55
56802X-57	112	5680B-5	112	5680X-38W	112	5681L-6X7	112	600MCB	55
56802X-6L	112	5680B-56L	112	5680X-39W	112	5681L-7	112	600MG	55
56802X-6L7	112	5680B-56X	112	5680X-3W	112	5681X	112	600MRS	55
56802X-6X	112	5680B-57	112	5680X-5	112	5681X-3	112	600N	55
56802X-6X7	112	5680B-6L	112	5680X-56L	112	5681X-3457W	112	600PBCA	55
56802X-7	112	5680B-6L7	112	5680X-56X	112	5681X-3458W	112	600ST	55
5680A	112	5680B-6X	112	5680X-57	112	5681X-3459W	112	6012N	38
5680A-3	112	5680B-6X7	112	5680X-6L	112	5681X-346L8W	112	6015N	39
5680A-347W	112	5680B-7	112	5680X-6L7	112	5681X-346L9W	112	6016N	39
5680A-348W	112	5680L	112	5680X-6X	112	5681X-346LW	112	601BD	56
5680A-349W	112	5680L-3	112	5680X-6X7	112	5681X-346X7W	112	601BK	56
5680A-35	112	5680L-347W	112	5680X-7	112	5681X-346X8W	112	601DG	56
5680A-356L	112	5680L-348W	112	5681L	112	5681X-346X9W	112	601IMCA	56
5680A-356X	112	5680L-349W	112	5681L-3	112	5681X-35	112	601IST	56
5680A-357	112	5680L-35	112	5681L-3457W	112	5681X-356L	112	601MBK	56
5680A-36L	112	5680L-356L	112	5681L-3458W	112	5681X-356X	112	601MCA	56
5680A-36L7	112	5680L-356X	112	5681L-3459W	112	5681X-357	112	601MCB	56
5680A-36X	112	5680L-357	112	5681L-346L7W	112	5681X-357W	112	601MDG	56
5680A-36X7	112	5680L-36L	112	5681L-346L8W	112	5681X-358W	112	601MG	56
5680A-37	112	5680L-36L7	112	5681L-346L9W	112	5681X-359W	112	601MMCA	56
5680A-37W	112	5680L-36X	112	5681L-346X7W	112	5681X-35W	112	601MN	56
5680A-38W	112	5680L-36X7	112	5681L-346X8W	112	5681X-36L	112	601MRS	56
5680A-39W	112	5680L-37	112	5681L-346X9W	112	5681X-36L7	112	601N	56

ADC Item	Cat. Page	ADC Item	Cat. Page	ADC Item	Cat. Page	ADC Item	Cat. Page	ADC Item	Cat. Page
601PBCA	56	603RGW	63	608IMRS	61	615FV	60	619TL	64
601RGBK	56	603SE	63	608IST	61	615G	60	619TQ	64
601ST	56	603SN	63	608LP	61	615HB	60	619V	64
6021N	38	603ST	63	608LPST	61	615HP	60	640BK	73
6021NCASE	38	603TL	63	608LV	61	615HPST	60	641BB	71
6021NSA	38	603TQ	63	608MBK	61	615LB	60	641BD	71
6021NX	38	603V	63	608MCA	61	615LP	60	641BK	71
6023NPC	38	603WD	63	608MCB	61	615LPST	60	641DG	71
6023NZAC	38	603WF	63	608MG	61	615LV	60	641FKW	71
6024N	37	603WFRGW	63	608MMCA	61	615MCA	60	641FL	71
602BD	57	603WO	63	608MMRS	61	615MCB	60	641FM	71
602BK	57	603ZB	63	608MR	61	615MG	60	641FPB	71
602DG	57	603ZBST	63	608MRS	61	615MR	60	641FPL	71
602N	57	604BK	67	608MRST	61	615MRS	60	641GR	71
603BD	63	604G	67	608MTL	61	615MRST	60	641LB	71
603BK	63	604LB	67	608MV	61	615N	60	641LV	71
603CFST	63	604MCA	67	608N	61	615O	60	641M	71
603COP	63	604MRS	67	608O	61	615P	60	641N	71
603DG	63	604P	67	608P	61	615PBCA	60	641NB	71
603FG	63	605BK	68	608PBCA	61	615R	60	641NGR	71
603FL	63	605G	68	608R	61	615RB	60	641NO	71
603FLT	63	605LB	68	608RB	61	615SE	60	641NP	71
603FRB	63	605MCA	68	608RGBK	61	615SN	60	641NY	71
603FS	63	605MRS	68	608RGW	61	615ST	60	641P	71
603FV	63	605P	68	608SE	61	615TL	60	641R	71
603G	63	606BD	58	608SN	61	615TQ	60	641RB	71
603GP	63	606BK	58	608ST	61	615V	60	641TL	71
603HB	63	606MCA	58	608TL	61	618KIT	69	641V	71
603HBRGW	63	606MRS	58	608TQ	61	618P	69	645	72
603HP	63	606N	58	608V	61	618SF	69	646ST	72
603HPST	63	606PBCA	58	611-20	48	618W	69	647BK	73
603IMCA	63	606RB	58	611-20-10	48	619BD	64	647HP	73
603IMRS	63	606RGBK	58	612BK	62	619BK	64	647N	73
603IST	63	606ST	58	612DG	62	619CHM	64	647RB	73
603LB	63	608BD	61	612N	62	619DG	64	647V	73
603LP	63	608BK	61	612RB	62	619FG	64	660BD	75
603LPST	63	608CF	61	612TL	62	619FL	64	660BK	75
603LV	63	608COP	61	613BKRB	79	619FRB	64	660BKH	76
603MCA	63	608DG	61	614BK	66	619FS	64	660G	75
603MCB	63	608FG	61	614G	66	619FV	64	660GD	75
603MG	63	608FL	61	614LB	66	619G	64	660GH	76
603MR	63	608FLT	61	614P	66	619LV	64	660LB	75
603MRS	63	608FRB	61	615BD	60	619N	64	660M	75
603MRST	63	608FS	61	615BK	60	619O	64	660N	75
603N	63	608FV	61	615CF	60	619P	64	660NO	75
603O	63	608G	61	615DG	60	619R	64	660NP	75
603P	63	608HB	61	615FG	60	619RB	64	660NY	75
603PBCA	63	608HBRGW	61	615FL	60	619RGBK	64	660P	75
603R	63	608HP	61	615FLT	60	619RGW	64	660R	75
603RB	63	608HPST	61	615FRB	60	619SM	64	660RB	75
603RGBK	63	608IMCA	61	615FS	60	619ST	64	660RBH	76

ADC Item	Cat. Page	ADC Item	Cat. Page	ADC Item	Cat. Page	ADC Item	Cat. Page	ADC Item	Cat. Page
660RH	76	676BK	75	7002-10SARB	15	703-7I0R1	17	720-9CPP	19
660TL	75	676BKH	76	7002-11ABK	15	703-9CBK	17	728-619-11ABD	27
660V	75	676G	75	7002-11AN	15	703-9CGR	17	728-619-11ABK	27
660Y	75	676GD	75	7002-11A0R	15	703-9CGR1	17	728-619-11ADG	27
660YH	76	676LB	75	7002-11ARB	15	705GPK-BK	31	728-619-11AG	27
661	80	676M	75	7002-11AV	15	705GPK-MCC	31	728-619-11AN	27
662	77	676N	75	7002-12XBD	15	705GPK-MCC1	31	728-619-11AN1	27
664BK	77	676NO	75	7002-12XBK	15	705GPK-N	31	728-619-11A0R	27
664Y	77	676NP	75	7002-13TBK	15	705PMK-BK	31	728-619-11AR	27
665RB	77	676NY	75	7002-13TBR	15	705PMK-MCC	31	728-619-11ARB	27
665Y	77	676P	75	7002-7IBK	15	705PMK-MCC1	31	728-619-11AST	27
670BD	75	676R	75	7002-7I0R	15	705PMK-N	31	728-619-11ATL	27
670BK	75	676RB	75	7002-9CBK	15	705PMK-PRT	31	728-619-11AV	27
670BKH	76	676TL	75	7002-9CGR	15	720-10SAAD	19	731-BK	32
670G	75	676V	75	700-7IBK	18	720-10SABK	19	731-MCC	32
670GD	75	676Y	75	700-7I0R	18	720-10SAPP	19	731-MCC1	32
670GH	76	697BCA	84	700-7I0R1	18	720-10SARB	19	731-N	32
670LB	75	697BK	84	700-9CAD	18	720-10SARB1	19	731-OR	32
670M	75	697BKL	84	700-9CBK	18	720-11AAD	19	732-BK	32
670N	75	698BK	84	700-9CGR	18	720-11ABCA	19	732-MCC	32
670NO	75	700-10SAAD	18	700-9CGR1	18	720-11ABD	19	732-MCC1	32
670NP	75	700-10SABK	18	700-9CPP	18	720-11ABK	19	732-N	32
670NY	75	700-10SAPP	18	703-10SABK	17	720-11ADG	19	732-OR	32
670P	75	700-10SARB	18	703-10SARB	17	720-11AG	19	740-MCC	33
670R	75	700-10SARB1	18	703-10SARB1	17	720-11AGR	19	740-MCC1	33
670RB	75	700-11AAD	18	703-11AAD	17	720-11AM	19	740-N	33
670RBH	76	700-11ABCA	18	703-11ABCA	17	720-11AMT	19	740-OR	33
670RH	76	700-11ABD	18	703-11ABD	17	720-11AN	19	750D-1	35
670TL	75	700-11ABK	18	703-11ABK	17	720-11AN1	19	750D-10SABK	35
670V	75	700-11ADG	18	703-11ADG	17	720-11A0R	19	750D-10SARB	35
670Y	75	700-11AG	18	703-11AG	17	720-11APBS	19	750D-10SARB1	35
670YH	76	700-11AGP	18	703-11AGR	17	720-11APP	19	750D-11ABK	35
671	80	700-11AGR	18	703-11AM	17	720-11AR	19	750D-11AN	35
675BD	75	700-11AM	18	703-11AMT	17	720-11ARB	19	750D-11AN1	35
675BK	75	700-11AMT	18	703-11AN	17	720-11AST	19	750D-12XBD	35
675BKH	76	700-11AN	18	703-11AN1	17	720-11ATL	19	750D-12XBD1	35
675G	75	700-11AN1	18	703-11A0R	17	720-11AV	19	750D-12XBK	35
675GD	75	700-11A0R	18	703-11APBS	17	720-12BXBD	19	750D-13TBK	35
675LB	75	700-11APBS	18	703-11APP	17	720-12XBD	19	750D-13TBR	35
675M	75	700-11APP	18	703-11AR	17	720-12XBD1	19	750D-13TBR1	35
675N	75	700-11AR	18	703-11ARB	17	720-12XBK	19	750D-7IBK	35
675NO	75	700-11ARB	18	703-11ATL	17	720-13TBK	19	750D-7I0R	35
675NP	75	700-11ATL	18	703-11AV	17	720-13TBR	19	750D-7I0R1	35
675NY	75	700-11AV	18	703-12XBD	17	720-13TBR1	19	750D-9CBK	35
675P	75	700-12XBD	18	703-12XBD1	17	720-7IBK	19	750D-9CGR	35
675R	75	700-12XBD1	18	703-12XBK	17	720-7I0R	19	750D-9CGR1	35
675RB	75	700-12XBK	18	703-13TBK	17	720-7I0R1	19	750W-10SABK	35
675TL	75	700-13TBK	18	703-13TBR	17	720-9CAD	19	750W-10SARB	35
675V	75	700-13TBR	18	703-13TBR1	17	720-9CBK	19	750W-10SARB1	35
675Y	75	700-13TBR1	18	703-7IBK	17	720-9CGR	19	750W-11ABK	35
676BD	75	7002-10SABK	15	703-7I0R	17	720-9CGR1	19	750W-11AN	35

ADC Item	Cat. Page	ADC Item	Cat. Page	ADC Item	Cat. Page	ADC Item	Cat. Page	ADC Item	Cat. Page
750W-11AN1	35	760-11AGRQ	20	768-11APP	28	778-11ADG	26	788-641-11AOR	25
750W-12XBD	35	760-11AM	20	768-11AR	28	778-11AG	26	788-641-11AR	25
750W-12XBD1	35	760-11AMQ	20	768-11ARB	28	778-11AM	26	788-641-11ARB	25
750W-12XBK	35	760-11AMT	20	768-11ATL	28	778-11AN	26	788-641-11ATL	25
750W-13TBK	35	760-11AMTQ	20	768-11AV	28	778-11AN1	26	788-641-11AV	25
750W-13TBR	35	760-11AN	20	768-641-10SAAD	28	778-11AOR	26	790-10SAN	40
750W-13TBR1	35	760-11ANQ	20	768-641-10SAPP	28	778-11AR	26	790-11AN	40
750W-7IBK	35	760-11AOR	20	768-641-11AAD	28	778-11ARB	26	790-12XN	40
750W-7IOR	35	760-11AORQ	20	768-641-11ABCA	28	778-11ATL	26	800	45
750W-7IOR1	35	760-11APBS	20	768-641-11ABD	28	778-11AV	26	8002	45
750W-9CBK	35	760-11APBSQ	20	768-641-11ABK	28	778-603-11AAD	26	8002-1	45
750W-9CGR	35	760-11APP	20	768-641-11ADG	28	778-603-11ABCA	26	8002-2	45
750W-9CGR1	35	760-11APPQ	20	768-641-11AM	28	778-603-11ABD	26	800GP	45
752M-10SABK	35	760-11AR	20	768-641-11AMT	28	778-603-11ABK	26	802	45
752M-10SARB	35	760-11ARB	20	768-641-11AN	28	778-603-11ADG	26	802ST	45
752M-10SARB1	35	760-11ARBQ	20	768-641-11AOR	28	778-603-11AG	26	804C3	48
752M-11ABK	35	760-11ARQ	20	768-641-11APBS	28	778-603-11AGP	26	804N	45
752M-11AN	35	760-11ATL	20	768-641-11APP	28	778-603-11AMT	26	804N-109	45
752M-11AN1	35	760-11ATLQ	20	768-641-11AR	28	778-603-11AN	26	805	45
752M-12XBD	35	760-11AV	20	768-641-11ARB	28	778-603-11AN1	26	808N	45
752M-12XBD1	35	760-11AVQ	20	768-641-11ATL	28	778-603-11AOR	26	809N	45
752M-12XBK	35	760-12XBD	20	768-641-11AV	28	778-603-11APBS	26	809SPU	45
752M-13TBK	35	760-12XBK	20	768-641-9CAD	28	778-603-11APP	26	8450-10SA-1	43
752M-13TBR	35	760-12XN	20	768-641-9CPP	28	778-603-11AR	26	8450-10SA-1HP	43
752M-13TBR1	35	760-12XOR	20	768-670-11ABD	28	778-603-11ARB	26	8450-10SA-2	43
752M-7IBK	35	760-13TBK	20	768-670-11ABK	28	778-603-11ATL	26	8450-10SA-2SC	43
752M-7IOR	35	760-13TBR	20	768-670-11AM	28	778-603-11AV	26	8450-11A-1	43
752M-7IOR1	35	760-13TN	20	768-670-11AN	28	780-10SAN	40	8450-11A-1HP	43
752M-9CBK	35	760-13TOR	20	768-670-11AOR	28	780-11AN	40	8450-11A-2	43
752M-9CGR	35	760-7IBK	20	768-670-11AR	28	780-12XN	40	8450-11A-2SC	43
752M-9CGR1	35	760-7IN	20	768-670-11ARB	28	785-10SAN	40	8450-11AL-1	43
752M-STAND	35	760-7IOR	20	768-670-11ATL	28	785-11AN	40	8450-11AL-1HP	43
760-10SAAD	20	760-9CAD	20	768-670-11AV	28	785-12XN	40	8450-11AL-2	43
760-10SABK	20	760-9CBK	20	768-9CAD	28	788-11ABD	25	8450-11AL-2SC	43
760-10SAN	20	760-9CGR	20	768-9CPP	28	788-11ABK	25	8450-12X-1	43
760-10SAOR	20	760-9CN	20	769-641-11ABK	29	788-11ADG	25	8450-12X-1HP	43
760-10SAPP	20	760-9COR	20	769-641-11AN	29	788-11AG	25	8450-12X-2	43
760-10SARB	20	760-9CPP	20	769-641-11AOR	29	788-11AM	25	8450-12X-2SC	43
760-11AAD	20	768-10SAAD	28	769-641-11ARB	29	788-11AN	25	8450-12XL-1	43
760-11AADQ	20	768-10SAPP	28	770-11AG	21	788-11AN1	25	8450-12XL-1HP	43
760-11ABCA	20	768-11AAD	28	774-10SADH	21	788-11AOR	25	8450-12XL-2	43
760-11ABCAQ	20	768-11ABCA	28	774-11ADH	21	788-11AR	25	8450-12XL-2SC	43
760-11ABD	20	768-11ABD	28	774-12XDH	21	788-11ARB	25	8450-13T-1	43
760-11ABDQ	20	768-11ABK	28	775-10SAN	21	788-11ATL	25	8450-13T-1HP	43
760-11ABK	20	768-11ADG	28	775-11AN	21	788-11AV	25	8450-13T-2	43
760-11ABKQ	20	768-11AG	28	775-11ANQ	21	788-641-11ABD	25	8450-13T-2SC	43
760-11ADG	20	768-11AM	28	775-12XN	21	788-641-11ABK	25	8450-1N-1L	43
760-11ADGQ	20	768-11AMT	28	775-13TN	21	788-641-11ADG	25	8450-1N-2L	43
760-11AG	20	768-11AN	28	775-9CN	21	788-641-11AM	25	8450-2N-1L	43
760-11AGQ	20	768-11AOR	28	778-11ABD	26	788-641-11AN	25	8450-2N-2L	43
760-11AGR	20	768-11APBS	28	778-11ABK	26	788-641-11AN1	25	8450-3N-1L	43

ADC Item	Cat. Page	ADC Item	Cat. Page	ADC Item	Cat. Page	ADC Item	Cat. Page	ADC Item	Cat. Page
8450-3N-2L	43	845-11AGR-1	46	845-780-12XN-2	47	865-11ADG	47	875PLF	45
8450-4N-1L	43	845-11AGR-2	46	845-790-10SAN-2	47	865-11AG	47	875PLF-10	45
8450-4N-2L	43	845-11AM-1	46	845-790-11AN-2	47	865-11AGR	47	880	128
8450-5N-1L	43	845-11AM-2	46	845-790-12XN-2	47	865-11AM	47	880L	128
8450-5N-2L	43	845-11AMT-1	46	845-7IBK-1	46	865-11AMT	47	880M	128
8450-7I-1	43	845-11AMT-2	46	845-7IBK-2	46	865-11AN	47	8814BK	128
8450-7I-1HP	43	845-11AN-1	46	845-7IN-1	46	865-11AOR	47	883B	128
8450-7I-2	43	845-11AN-1HP	46	845-7IN-2	46	865-11APBS	47	8830	128
8450-7I-2SC	43	845-11AN-2	46	845-7IOR-1	46	865-11APP	47	884	49
8450-9C-1	43	845-11AOR-1	46	845-7IOR-1HP	46	865-11AR	47	885N	49
8450-9C-1HP	43	845-11AOR-2	46	845-7IOR-2	46	865-11ARB	47	886N	49
8450-9C-2	43	845-11APBS-1	46	845-9CAD-1	46	865-11ATL	47	887BK	128
8450-9C-2SC	43	845-11APBS-2	46	845-9CAD-2	46	865-11AV	47	887DB	128
845-10SAAD-1	46	845-11APP-1	46	845-9CBK-1	46	865-12BXBD	47	8870	128
845-10SAAD-2	46	845-11APP-2	46	845-9CBK-2	46	865-12XBD	47	887RB	128
845-10SABK-1	46	845-11AR-1	46	845-9CGR-1	46	865-12XBK	47	888AD	128
845-10SABK-1F	46	845-11AR-2	46	845-9CGR-1HP	46	865-12XN	47	888BCA	128
845-10SABK-2	46	845-11ARB-1	46	845-9CGR-2	46	865-12XOR	47	888BD	128
845-10SAN-1	46	845-11ARB-2	46	845-9CN-1	46	865-13TBK	47	888BK	128
845-10SAN-2	46	845-11ATL-1	46	845-9CN-2	46	865-13TBR	47	888DB	128
845-10SAOR-1	46	845-11ATL-2	46	845-9COR-1	46	865-13TN	47	888DG	128
845-10SAOR-2	46	845-11AV-1	46	845-9COR-2	46	865-13TOR	47	888G	128
845-10SAPP-1	46	845-11AV-2	46	845-9CPP-1	46	8651-7IOR	47	888M	128
845-10SAPP-2	46	845-12BXBD-1	46	845-9CPP-2	46	8651-9CGR	47	888MT	128
845-10SARB-1	46	845-12BXBD-1HP	46	850-6012N	41	865-7IBK	47	8880	128
845-10SARB-1HP	46	845-12BXBD-2	46	850-6021NSA	41	865-7IN	47	888PBS	128
845-10SARB-2	46	845-12XBD-1	46	850-6022N	41	865-7IOR	47	888PP	128
8451-10SARB-1	46	845-12XBD-1HP	46	850-6022NX	41	865-9CAD	47	888R	128
8451-10SARB-1HP	46	845-12XBD-2	46	850-6023N	41	865-9CBK	47	888RB	128
8451-10SARB-2	46	845-12XBK-1	46	8650-10SA	43	865-9CGR	47	888TL	128
8451-11AN-1	46	845-12XBK-1F	46	8650-11A	43	865-9CN	47	888V	128
8451-11AN-1HP	46	845-12XBK-2	46	8650-11AL	43	865-9COR	47	891	48
8451-11AN-2	46	845-12XN-1	46	8650-12X	43	865-9CPP	47	891F	48
8451-12XBD-1	46	845-12XN-2	46	8650-12XL	43	870-1	50	891F-10	48
8451-12XBD-1HP	46	845-12XOR-1	46	8650-13T	43	870-1GP	50	891M	48
8451-12XBD-2	46	845-12XOR-2	46	8650-7I	43	870-1ST	50	891M-10	48
8451-13TBR-1	46	845-13TBK-1	46	8650-9C	43	870LN	45	893	50
8451-13TBR-2	46	845-13TBK-2	46	865-10SAAD	47	870N	45	895	50
845-11AAD-1	46	845-13TBR-1	46	865-10SABK	47	870NGP	45	896	50
845-11AAD-2	46	845-13TBR-2	46	865-10SAN	47	870NST	45	8971-10	48
845-11ABCA-1	46	845-13TN-1	46	865-10SAOR	47	871	45	8971F-10	48
845-11ABCA-2	46	845-13TN-2	46	865-10SAPP	47	871GP	45	8972-10	48
845-11ABD-1	46	845-13TOR-1	46	865-10SARB	47	871ST	45	8973-10	48
845-11ABD-2	46	845-13TOR-2	46	8651-10SARB	47	872LN	45	8974-10	48
845-11ABK-1	46	8451-7IOR-1	46	8651-11AN	47	872N	45	8974F-10	48
845-11ABK-1F	46	8451-7IOR-2	46	8651-12XBD	47	872NGP	45	8974M-10	48
845-11ABK-2	46	8451-9CGR-1	46	8651-13TBR	47	872NST	45	8975-10	48
845-11ADG-1	46	8451-9CGR-2	46	865-11AAD	47	873-1	50	898	50
845-11ADG-2	46	845-770-11AG-2	47	865-11ABCA	47	873N	45	899BK	49
845-11AG-1	46	845-780-10SAN-2	47	865-11ABD	47	874	45	8990	49
845-11AG-2	46	845-780-11AN-2	47	865-11ABK	47	875N	45	9000PCAU	N/A

ADC Item	Cat. Page	ADC Item	Cat. Page	ADC Item	Cat. Page	ADC Item	Cat. Page	ADC Item	Cat. Page
9000PCEU	N/A	9003M	6	9005BPSTO	5	9005TOK	N/A	9290MF	N/A
9000PCUK	N/A	9003TS1	6	9005BPTO	5	9005TR	N/A	9290MI	N/A
9000QCF-10	5	9003TS2	6	9005CK	N/A	9005TRK	N/A	9290MIF	N/A
9000QCM-10	5	9003TUBE	N/A	9005CKA	N/A	9005TWB	N/A	952-025	49
9000TOP	N/A	9003W	6	9005CKP	N/A	9005TWR	N/A	980SK	50
9000TP	N/A	9005-10SARB-1MB	N/A	9005D	5	9005USB	N/A	991	50
9000TRP	N/A	9005-11AN-1MB	N/A	9005DON	5	9005W	5		
9003ADAPT	N/A	9005-12XBD-1MB	N/A	9005PC	N/A	9006M	5		
9003BAG	128	9005-13TBR-1MB	N/A	9005S	N/A	920-011	48		
9003BAT	N/A	9005-9CGR-1MB	N/A	9005SCAN2D	5	920-011-10	48		
9003CK	N/A	9005BAT	N/A	9005SCANL	5	925110E	N/A		
9003CON	N/A	9005BP	5	9005SM	N/A	925110N	N/A		
9003CT	N/A	9005BPC	N/A	9005SP	N/A	925111N	N/A		
9003D	6	9005BPS	5	9005SPC	N/A	925112N	N/A		
9003K-MCC	6	9005BPSM	N/A	9005TCP	N/A	9251XXS	N/A		
9003K-MCC1	6	9005BPSMTO	N/A	9005TO	N/A	9290M	N/A		

Color and Ordering Charts

Our enhanced ordering charts make it easy to locate part numbers. They include model numbers, color options, and additional variables, like size, where relevant. For more information about color choices, including special finishes, visit www.adctoday.com/colorchart.

Stethoscope Color Chart

Tubing Colors: Standard Brushed Finish

BK	BD	DG	FG	FL	FRB
FS	FV	G	LV	MCB	MCA
MG	MRS	N	O	P	PBCA
R	RB	TL	TQ	V	

Tubing Colors: Mirror Finish

MBK	MMCA
MMRS	MTL
MV	

Tubing Colors: Iridescent Finish

IMCA	IMRS
IST	

Additional Finishes

Blood Pressure Color and Ordering Charts

Ordering Information	Description
788-11A**	Pro's Combo I Palm Aneroid (Adult Only)
788-641-11A**	Pro's Combo I Palm Aneroid/Sprague (Adult Only)

Additional Adult Cuff Color Options

BK	BD	DG	G	M	N*
OR	R	RB	TL	V	

NOTE: To ensure correct cuff color when ordering, add color suffix to model number (e.g., 788-641-11AV)

Special Prints and Print Themes

Some products are available in special prints. Visit <https://www.adctoday.com/products/Color-and-Print-Themes> for more information.



adscope^{LE}

Adscope LE is our collection of specially curated, limited-edition printed stethoscopes. Prints are offered in three clinician models: 603, 608, and 615. Some styles are also available with a Rose Gold or Tactical finish.

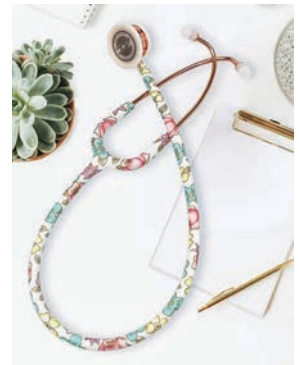

Learn more: www.adctoday.com/AdscopeLE

Icons Used on Product Pages

Medical Compatibilities	Blood Pressure	
MRI Safe Medical Device Auto Averaging BHS Validated	Size Guide™ Luminescent Dial Self Adjusting Cuff Adflow™ Valve Extended Scaleplate Irregular Heartbeat AM/PM Readings Traffic Light Indicator	
Thermometry	Memory	
1 Second Reading 2 Second Reading 3 Second Reading 8 Second Reading 10 Second Reading 30 Second Reading 60 Second Reading Dual Scale Water Resistant Flexible Probe Audible Alert Splash Proof Night Mode	Last Reading Last 9 Readings Last 12 Readings Last 14 Readings Last 30 Readings Last 30 Readings 2 patients Last 99 Readings 2 patients Last 99 Readings	
Stethoscopes	General	Power Supply
AFD Technology Adsoft™ Plus Ear tips Ultra-light Weight Stainless Steel Cardiology Headset Convertible Chestpiece Made without natural latex Made without rubber without Phthalates Backlit Display Jumbo Display Single Use European Union Approved Not Sterile PC link Included PC link Available Battery Included Battery Not Included AC Adapter Included AC Adapter Available Rechargeable Battery Included	CE Not Sterile PC link Included PC link Available Battery Included Battery Not Included AC Adapter Included AC Adapter Available Rechargeable Battery Included	Battery Included Battery Not Included AC Adapter Included AC Adapter Available Rechargeable Battery Included
Calibration Warranty Coverage	Parts Warranty Coverage	U.S.A. Content
2 Year 5 Year 10 Year 20 Year Lifetime	1 Year 2 Year 3 Year 5 Year 10 Year Lifetime Multiple	Inspected, Assembled & Packaged Inspected & Assembled Inspected Inspected & Packaged Made in USA

Our Promise to You

Because of our commitment to provide the very highest quality products and service, ADC has worked successfully towards certification to the ISO 13485:2016 quality management system standard under the Medical Device Single Audit Program or MDSAP.

The ISO 13485:2016 standard is specifically designed to be applicable to medical device manufacturers, and includes requirements for quality, management responsibility, and commitment to continually improving our products and services. The MDSAP program is a global system, involving regulations from multiple countries rolled into a single audit to ensure that ADC's systems meet the requirements of key global markets. The designation was earned from UL LLC, a leading international standards, testing, registration, and certification organization.

Why Be ISO Certified?

While no organization must be ISO 13485:2016 certified, it has become a standard for conducting business in the international arena. In fact, ISO 13485:2016 is the primary quality system standard accepted internationally for medical device manufacturers. ADC's certification, which was earned after a thorough, independent audit of our

quality management system, facilitates our company's CE marking of products for sale in Europe. It is also recognized by Canadian, Australian, Japanese, and US regulatory authorities as showing compliance with regulations in each of these countries.

A quality management system under ISO 13485:2016 also ensures that our products and services are monitored for safety, effectiveness, and for opportunities for improvement. To keep this certification, a company must maintain this commitment and incorporate a process of continual improvement and satisfaction into all aspects of our business activities.

Everyone at ADC is part of the ISO experience; it's a company-wide philosophy of business practices that puts the needs of our customers at the center of all that we do. ISO certification isn't one time, it's a continuous quality-improvement process.

And that's our promise to you.



Scan here to learn more about ISO and the medical device standard.



55 Commerce Drive
Hauppauge, NY 11788
tel: 1-800-232-2670 • fax: 631-273-9659

