

Operation & Maintenance Manual

Apollo MS



Amico

Table of Contents

Specifications	3-4
Description of Symbols	5
Warnings	6-7
Intended Use	8
Introduction	8
Features	9
Siderail & Footboard Controls	10
Siderail Controls	11
Footboard Controls	12
Central Locking System	13
Installation and Removal of the Head/Footboards	14
Siderails	14-15
Electrical	15
Preventive Maintenance	16
Cleaning Procedures	17
Cable Schematic	18
Troubleshooting	19-21
Head Siderail Replacement	22
Foot Siderail Replacement	23
Batteries	24
Control Boxes with Battery Back Up Only	25-27
Components List	28-31
Accessories List	32
Replacement Parts List	33-36
Cables	37
Electromagnetic Compatibility	38-41
Warranty	42
Notes	43

Specifications

Model Number	Model Identification/Description	
B-AM1-4000	Apollo MS (MedSurg Bed)	
Feature	Dimension (inches)	Dimension (cm)
Total Length	92	234
Maximum Width	42	107
Mattress to Siderail Height	9	23
Maximum Under Bed Clearance	6	15
<i>Surface Dimensions</i>		
Surface Width	35	89
Surface Length	84	213
Surface Mattress Thickness	6	15
<i>Litter Section</i>		
Fowler Length	32.5	83
Fowler Width	34	86
Seat Length	6	15
Seat Width	34	86
Knee Gatch Length	12.25	31
Knee Gatch Width	34	86
Foot Section Length	25	64
Foot Section Width	34	86
Caster Size	5 inches diameter	13 cm diameter
Bed Lift Capacity (Safe Working Load)	550 lbs maximum	250 kg maximum
Total Weight without Surface	450 lbs maximum	204 kg maximum
Head Section Inclination (maximum)	60 ± 5 degrees	
Knee Section Inclination (maximum)	25 ± 5 degrees	
Bed Height Range, Lowest Position*	15.5	40
Bed Height Range, Highest Position*	27	69
Trendelenburg Position (maximum)	12 degrees ± 1	
Reverse Trendelenburg Position (maximum)	12 degrees ± 1	
AC Power Requirements		
Voltage (Volts)	120 maximum	
Current (Amps)	6.0 maximum	
Frequency (Hertz)	50/60	
Duty Cycle		
Continuous Operation w/ Intermittent Load	10%, maximum 2 min. LOAD/18 min. REST	
Patient Characteristics	Dimension (inches)	Dimension (cm)
Height	88 maximum	224 maximum
Width	36 maximum	91 maximum
Weight	350 lbs	159 kg

Specifications

Classification and Standards	
UL 60601-1,	
CSA C22.2 No 601.1-M90,	
IEC 60601-1-2-38	
Equipment Classification	Class 1, Type B
Environmental Conditions for Transport and Storage	
Temperature	-40° F to 158° F (-40° C to 70° C)
Relative Humidity	95% non-condensing
Pressure	50 KPa to 106 KPa
Environmental Conditions for Use	
Temperature	50° F to 95° F (10° C to 35° C)
Relative Humidity	20% to 85% non-condensing
Pressure	70 KPa to 106 KPa

*without mattress

Description of Symbols

This document contains different typefaces and symbols designed to improve readability and increase understanding of its content.









The symbol below highlights a **WARNING** or **CAUTION**.



WARNING: Identifies situations or actions that may affect patient or user safety. Disregarding a warning could result in patient or user injury.



CAUTION: Points out special procedures or precautions that personnel must follow to avoid equipment damage.

Symbol	Description
	Type B applied part according to IEC 60601-1 (UL 60601-1).
IPX4	According to IEC 60529, rating for protection against fluid ingress and identified as equipment that is protected against spraying and splashing water.
IPX0	Ordinary equipment not rated for fluid ingress per IEC60529. This applies to exam light control box ONLY.
	CAUTION: Consult accompanying documents.
CPR	CPR control - activates the CPR function.
	CAUTION: Pinch Point for hands. Keep hands clear.
	CAUTION: Pinch Point for feet. Keep feet clear.
	CAUTION: Note the orientation of the Headboard when installing onto bed frame.
	Earth Ground Location
	Equipotential Ground Location
	Safe Working Load - Shows the safe working load of the bed.



WARNING: Do not operate the bed beyond the recommended Patient Characteristics. Failure to observe this warning may result in patient injury or equipment damage.

Warnings



WARNING: To avoid risk of electric shock, this equipment must only be connected to a main power supply with protective earth.



WARNING: To prevent damage to the AC power cord, remember the following:

- Disconnect the plug from the mains outlet prior to moving the bed.
- Provide some slack in the cord between the bed and the main outlet (i.e., the cord should not be pulled taut or under tension).
- Try to keep the power cord off of the floor (use the cord clip provided when possible). This will prevent other equipment from crushing the cable.



WARNING: The multi-pin connector for Nurse Call function is intended only for connection to the hospital's nurse station communication system, or medical equipment complying with IEC 60601-1:1988 + A1:1991 + A2:1995.



WARNING: The AC power cord is considered a main power isolation device. Avoid plugging the AC power cord in a hard-to-reach location (e.g., behind equipment or furniture). In the event of an emergency, the power cord must be readily accessible for disconnection.

To prevent possible equipment damage during bed articulation, position the bed at least 1' (30 cm) away from the headwall.

Prior to operating the bed movement controls, ensure that all persons or equipment are clear of the bed mechanisms. To stop a movement, immediately release the button being pressed.

The bed height should be set to the LOWEST POSITION any time the patient will be left unattended. This is to reduce the risk of injury due to patient falls.

Depending on the condition of the patient, the bed platform should be placed in the FLAT POSITION any time the patient will be left unattended. This is to reduce the risk of patient entrapment.

The "Lock Out" controls should be used by the caregiver to restrict visitors or patients from accessing the associated functions. It is recommended to lock any functions that may cause injury to the patient.

Patient's visitors should be instructed not to use the caregiver controls. The visitor may assist the patient via the patient controls.

Patients should be monitored intermittently to ensure correct patient positioning on the bed and proper usage of siderails.

Note the location of cords or hoses during bed movements. Proper line management is essential to reduce the chance of catching or pinching hazards from occurring.

Only use accessories approved for the Apollo MS bed. See "Accessories List" (Page 32) for list of approved accessories and usage guidelines.

Warnings

The bed should be installed, cleaned and used as described within this manual.

The bed should be operated by facility caregivers and facility-authorized service personnel only.

The maximum load capability of the bed including the patient surface is 550 lbs (250 kg). Exceeding load restrictions could cause excessive wear to the parts and damage the bed, resulting in patient injury or death.

Entering and exiting the bed has to be done at the side with the siderails lowered completely.

Avoid sitting at the extreme ends of the bed (Fowler Section and Foot Section).

It is recommended not to use water or silicone surfaces in order not to exceed the maximum weight limit of 550 lbs (250 kg).

For information on "Cleaning Procedures", please see Page 17.

For information on "Electromagnetic Compatibility", please see Pages 38-41.

Intended Use

The Apollo MS bed is intended for patients in Acute-Care and L.T.A.C. hospitals. This Manual provides instructions required for normal operation of the Apollo MS bed from Amico Beds Corporation. Prior to operation of this bed, it is important that this manual is read and ensure that all safety aspects contained in this manual are strictly adhered to.

Introduction

The Apollo MS has been designed specifically to help caregivers assist patients in the Acute-Care and long-term acute care. This bed features several features such as the integrated foot extender, removable headboard and footboard, and a battery back-up system.

The motions of the Apollo MS are achieved by independent DC electric motors through controls located on the siderails of the bed allowing positions to be changed. The motors are also equipped with overheat protection.

This allow easier maneuverability during patient transport and to help avoid back injury in the caregivers. The battery back-up system also provides peace of mind during transportation or unexpected power outages, allowing the bed positions to be adjusted accordingly.

Features

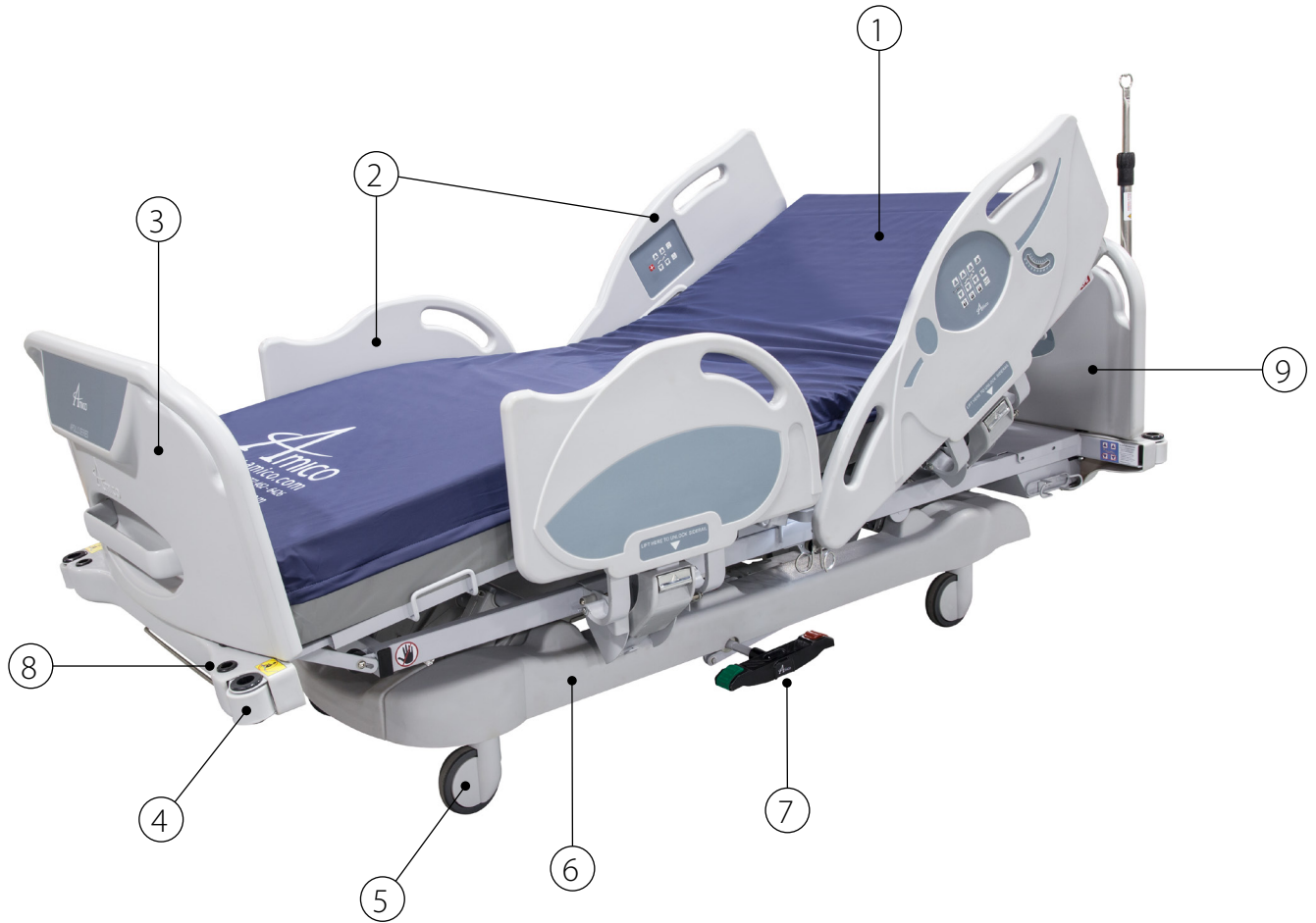

Item	Description	Item	Description
1	Mattress	6	Base Cover
2	Foldable Siderails	7	Brake Pedal
3	Footboard	8	IV Pole Mounting Socket
4	Corner Roller Bumpers	9	Headboard
5	5" (13 cm) Urethane Casters		

Siderail & Footboard Controls

The Apollo MS utilizes four 24 V DC LINAK actuators to enable the bed to achieve the following motions:

- Head (Fowler) UP
- Head (Fowler) DOWN
- Knee UP
- Knee DOWN
- Bed UP
- Bed DOWN
- Trendelenburg
- Reverse Trendelenburg

Bed motions can be controlled via the exterior siderail controls for caregivers and interior siderail controls for patients*. Optional controls include Footboard controls for caregivers and a hand pendant for patients to adjust a position press and hold down the appropriate button. Only one operation can be made at a time. (i.e., Do not try and adjust knee gatch and bed height at the same time).

Siderail Controls

Button	Name	Function
A	Bed Height Up	Press on this button to raise height of bed to desired position.
B	Bed Height Down	Press on this button to lower height of bed to desired position.
C	Knee Gatch Up	Press on this button to raise knee gatch section to the desired angle.
D	Knee Gatch Down	Press on this button to lower knee gatch section to the desired angle.
E	Fowler Up	Press on this button to raise fowler section of the bed to desired angle.
F	Fowler Down	Press on this button to lower fowler section of the bed to desired angle.
G	Reverse Trendelenburg	Press on this button to place the bed in the desired reverse Trendelenburg position.
H	Trendelenburg	Press on this button to place the bed in the desired Trendelenburg position.
I	Bed Flat	Press this button to achieve a flat position from any articulated position. If a flat patient surface and level upper frame is desired, press and hold this button. After 30 seconds, the bed will move to the Low Height, thus attaining a level upper frame.
J	Lock Out	Press this button to lock-out the movement functions directly above the button. Press it again to unlock the functions.

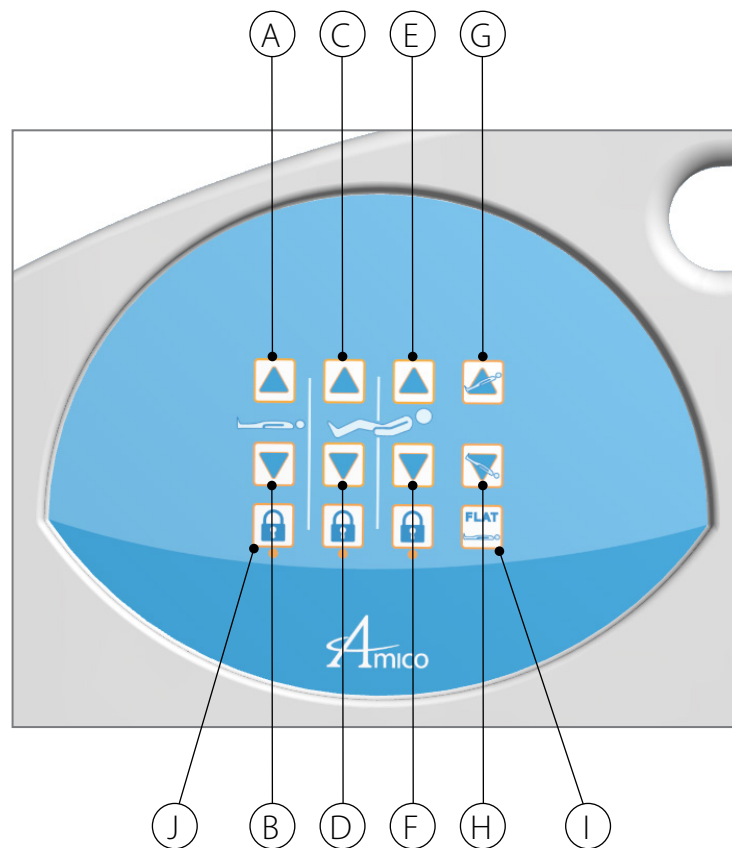

***NOTE:** For the safety of the patient, only the Head UP/DOWN and Knee UP/DOWN motions are available on the interior siderail controls. It is recommended that the Lock-Out feature be used to restrict these motions if articulation may cause the patient further injury.

Footboard Controls

Button	Name	Function
A	Bed Height Up	Press on this button to raise height of bed to desired position.
B	Bed Height Down	Press on this button to lower height of bed to desired position.
C	Knee Gatch Up	Press on this button to raise knee gatch section to the desired angle.
D	Knee Gatch Down	Press on this button to lower knee gatch section to the desired angle.
E	Fowler Up	Press on this button to raise fowler section of the bed to desired angle.
F	Fowler Down	Press on this button to lower fowler section of the bed to desired angle.
G	Reverse Trendelenburg	Press on this button to place the bed in the desired reverse Trendelenburg position.
H	Trendelenburg	Press on this button to place the bed in the desired Trendelenburg position.
I	Bed Flat	Press this button to achieve a flat position from any articulated position. If a flat patient surface and level upper frame is desired, press and hold this button. After 30 seconds, the bed will move to the Low Height, thus attaining a level upper frame.
J	Lock Out	Press this button to lock-out the movement functions directly above the button. Press it again to unlock the functions.
K	Total Lock-Out	Press this button to lock ALL bed movement functions. Press it again to unlock the functions.
L	Battery Indicator	Indicator will be GREEN when bed is plugged in and battery is charging. Indicator will be AMBER when the bed is operating on battery power only and requires charging.
M	Maintenance Indicator	Indicator will be lit when an error is detected. The bed should be removed from operation and sent for maintenance as soon as possible.

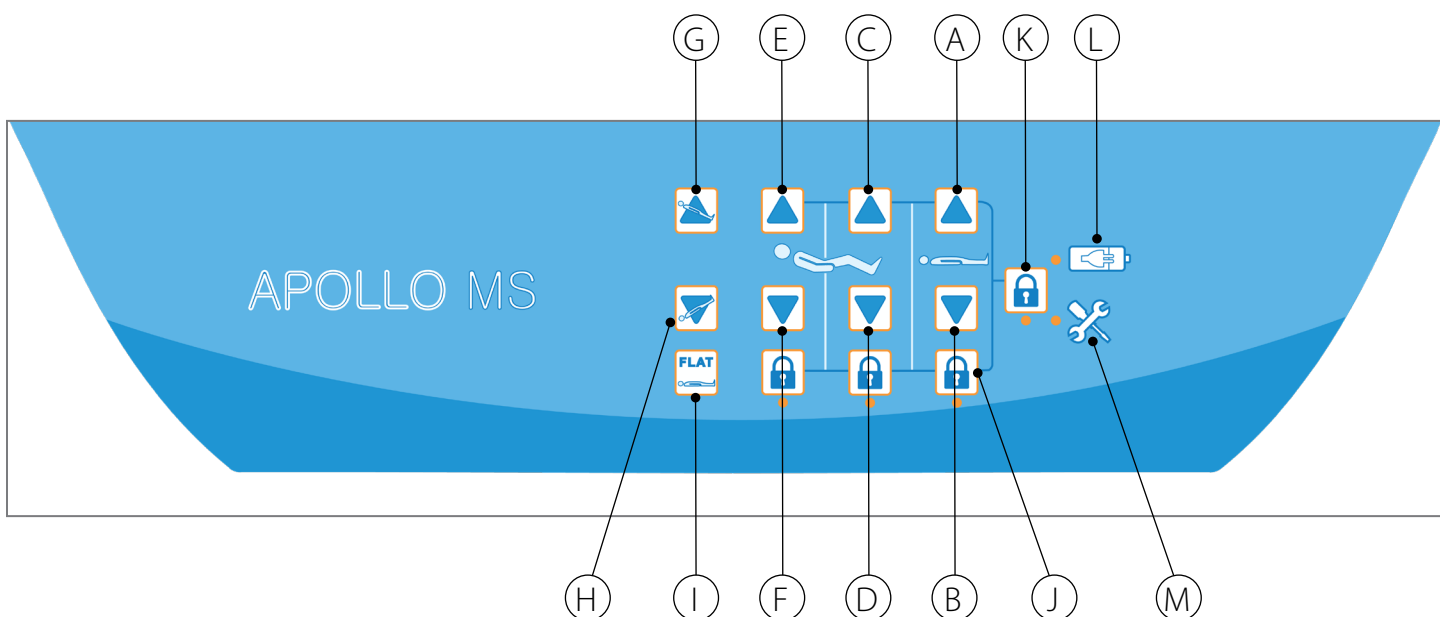

NOTE: Buttons A, B, C, D, E, F, G, H, I and J are same functionality as siderails buttons.

NOTE: The “Total Lock Out” feature (Button K) will disable all bed movement controls except for emergency CPR.

NOTE: “Lock Out” features (Buttons J and K) will also disable bed movement controls on the Patient Hand Pendant.

Central Locking System

Locking the Bed:

- a. To place the bed into a locked position, push down on the Red pedal with your foot. Ensure that the brakes are properly locked in place before moving away from the bed. To ensure that the brakes are engaged, try moving the bed slightly.

Unlocking the Bed:

- a. To unlock the bed, push down on the Green pedal with your foot.



CAUTION: The Locking System should always be set to BRAKE unless the bed is going to be moved.



Using the CPR Release Lever:

- a. To use the CPR Release Lever, pull the lever outward with one hand and slowly push the fowler section down with the other hand.

NOTE: The CPR Release should only be used for emergencies only. It is recommended that the fowler section is completely lowered to a flat position when the CPR release lever is used. Avoid using the CPR Release to attain an angled fowler.

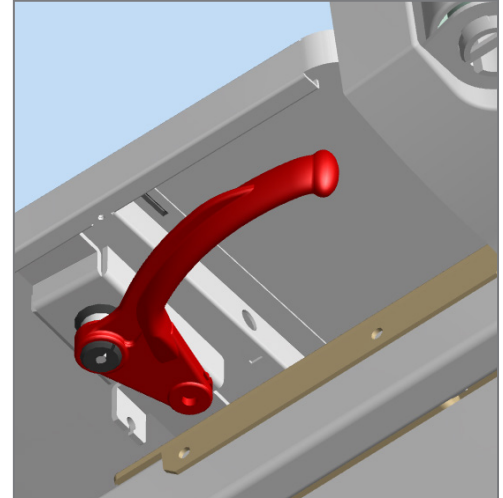

Installation and Removal of the Head/Footboards

To install the Footboard, align the pins on the foot extension section with the corresponding plastic guides. Allow the footboard pins to slide into the plastic guides. The connector for the board controls should also mate with the male connector on the bed. Ensure that the footboard is properly inserted before use.

To install the Headboard, align the pins with the corresponding plastic guides on the head end support of the bed. Insert the headboard by pushing the pins into the guides. Ensure that the headboard is properly inserted before use.

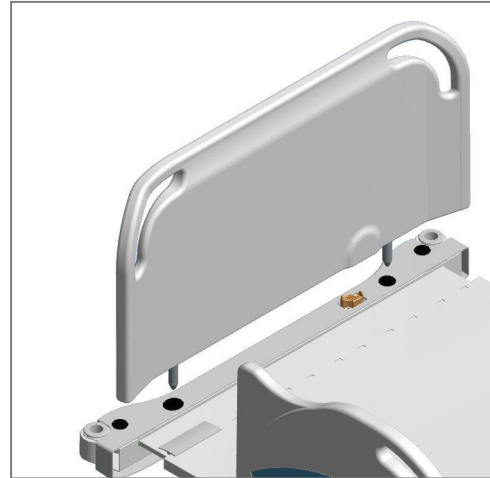
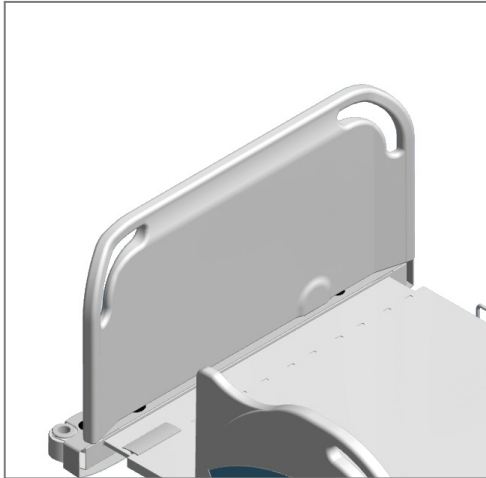

To remove headboard/footboard, lift vertically until the pins come out of the plastic guides.

Siderails

Lowering Siderails:

- a. To lower the siderails, place hand under the plastic latch and pull forward. Once latch is released, the siderail will slowly lower.



Siderails

Raising Siderails:

- a. To raise the siderails, place both hands on the rail and gently pull up. Once the rail reaches the top, it will lock in place. Ensure that the siderail is properly locked in place before using the bed or leaving the patient to avoid patient injury.

NOTE: Patients should be monitored intermittently to ensure correct patient positioning on the bed and proper usage of siderails.

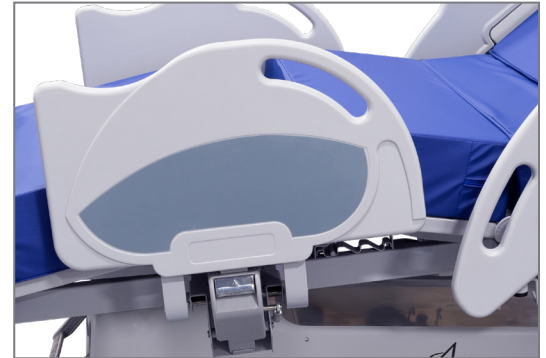

Electrical

This product comes with a battery backup system which includes one sealed, lead-acid 12 V battery located in the control unit box. To ensure that the battery has a full charge, refer to the “Batteries” section on Page 24.

The Apollo MS features two exterior siderail controls for caregivers and two interior siderail controls for patients.

The Apollo MS utilizes a multi-pin jack to connect to the hospital’s nurse call system. The jack is located at the head-end of the bed on the patient’s left side. To connect the nurse call feature, plug one end of the multi-pin cord* into the bed-mounted jack and the other end into the wall-mounted jack.

***NOTE:** The multi-pin cord (37-pin Nurse Call Connector) is an optional item from Amico Beds and may not be included with your product. If a multi-pin cord is required, please see the “Cables” section of the manual for a part number and contact Amico Beds CSR to place an order.

Preventive Maintenance



WARNING: Only facility-authorized personnel should service the Apollo MS bed. Servicing performed by unauthorized personnel could result in personal injury or equipment damage.

The Apollo MS bed requires an effective maintenance program. We recommend that you perform annual preventive maintenance (PM) and testing for Joint Commission on Accreditation of Health Care Organizations (JCAHO). PM and testing not only meet JCAHO requirements but will help ensure a long, operation life for the Apollo MS bed.

Preventive maintenance will minimize downtime due to excessive wear.

Perform annual preventive maintenance procedures to make sure all Apollo MS bed components are functioning as originally designed. Pay particular attention to safety features that include, but are not limited to, the following:

- Condition of the Headboard, Footboard, and Siderails
- Siderail latching mechanisms
- Caster braking systems
- Integrity of sleep surface ticking
- Integrity of warning/cautions labels
- Integrity of the various cables (AC power, signal cables, etc.)

Cleaning Procedures

Bleach Cleaning Instructions

If none of the approved cleaning products provide the disinfectant level required then use a solution of 5.25% Sodium Hypochlorite diluted to 1 part bleach to 50 parts water (1,000 ppm), (volume to volume).

Bleach products are corrosive and degrading in nature and may cause damage to your product. If bleach is used, measures must be taken to ensure the product is rinsed thoroughly with clean water and thoroughly dried. Failure to rinse and dry the product will leave a corrosive residue on the surface possibly causing corrosion.

NOTE: Failure to follow the above directions may void the product's warranty.

- Do not expose the bed to excessive moisture
- Do not immerse the bed or its components in water
- Do not attempt to clean or degrease the steel shafts of the actuators
- Use only approved cleaning products. If bleach is being applied to the product, strictly adhere to the "Bleach Cleaning Instructions".
- For electrical components, please do not unplug the handset or actuators from the control box for cleaning
- Do not use a water temperature of more than 50° C or 122° F

NOTE: For mattresses, please refer to mattress cleaning instructions.

Before Cleaning

- Disconnect or unplug the power cord from the main supply
- Set the bed to BRAKE by pressing on the brake pedals

During Cleaning

- Do not use abrasive cleaning products
- Do not use oil-based products
- Do not use a steam cleaner, washing tunnel, high-pressure spray or hose

To Wash:

- Wipe with a sponge or soft cloth wetted with warm water containing soap or mild detergent

To Dry:

- Thoroughly wipe with a dry sponge or soft cloth

To Disinfect:

- Wash the surface with one of the approved cleaners or refer to the "Bleach Cleaning Instructions" if bleach needs to be used
- Wipe off residue with water using a soft cloth or sponge
- Thoroughly dry

Cable Schematic

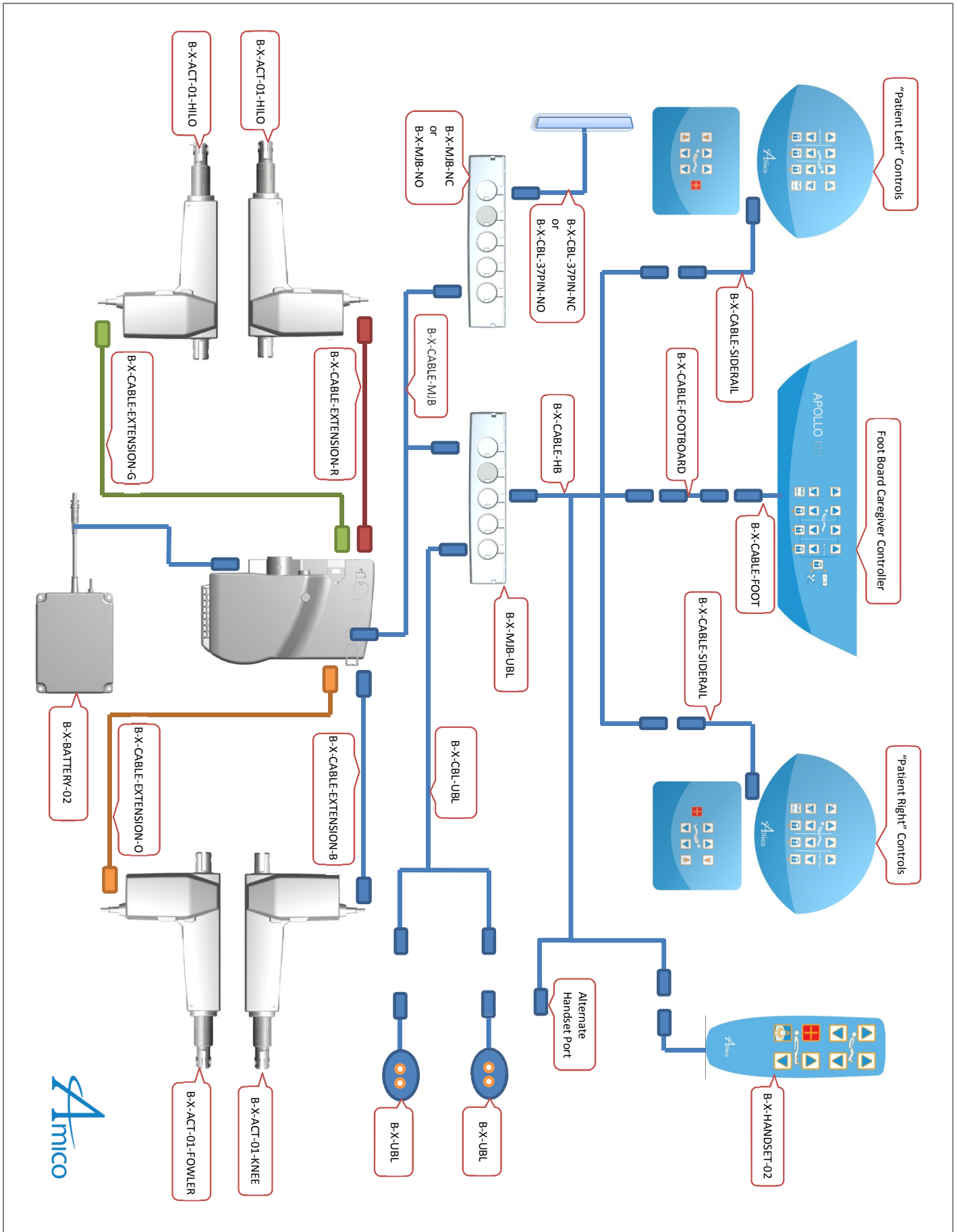



Troubleshooting

The following tools may be required:

- 3/8" wrench
- 7/16" combination wrench
- 1/2" combination wrench
- 9/16" combination wrench
- Philips-head screwdriver (Sizes #1 and #2)
- Slot-head screwdriver
- Needle-nose pliers
- Rubber mallet
- Cable ties
- Wire cutter
- Multimeter/voltmeter
- If any cables need to be replaced, consult the "Cable Schematic" and note the corresponding part number.
- To remove damaged cables, use the wire cutters to remove any cable ties holding the cable in place. Note the location of the cable tie(s) so that the new cable is secured in the same place(s).

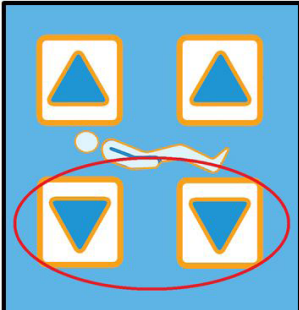
Troubleshooting

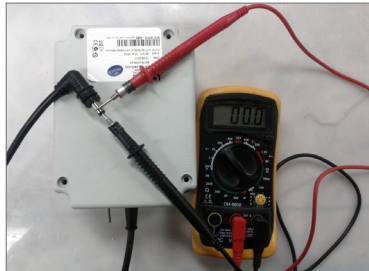
Item No.	Problem Descriptions	Troubleshooting Steps
1	<p>Bed “beeps” when buttons are pressed or the “Maintenance Indicator” LED is ON:</p>  <p>To RESET the Control Unit:</p> <ol style="list-style-type: none"> 1) On any Bed Control Interface, <u>press and hold</u> the circled buttons SIMULTANEOUSLY. 2) The Control Unit will “beep” several times (if there is no “beeping”, repeat Step 1). Continue to hold the buttons until the “beeping” stops. 3) Release the buttons. 	<ol style="list-style-type: none"> a. Check to see if the bed is plugged into a mains power outlet. If not, plug in the bed and retry to controls. If movement is achieved and the “beep” disappears, leave the bed connected to the power outlet to charge the battery (see “Battery Charging Characteristics” on Pg. 26). b. If the bed is plugged in and the “beeps” still occur, reset the Control Unit by following the steps below.
2	<p>No motion when controls are pressed.</p>  	<ol style="list-style-type: none"> a. Connect bed to wall outlet and try again. If motion can be achieved, this means that the battery level may be low. Leave bed connected to wall until full charge is completed. (See “Battery Charging Characteristics” on Page 26). b. If functions are lost again when the bed is disconnected from the wall outlet, the battery may be faulty. To check this, raise the Fowler to the upright position to access the Control Box. c. Disconnect the bed from the wall outlet. Remove the Control Box Cover (3 screws). The battery is held to the pan via Phillips-head machine screws. d. Using a slot-head screwdriver, remove the locking clip that secures the battery jack in the Control Unit. Pull out the battery jack and remove the battery from the pan. e. Using a voltmeter set at 200 V, test the battery voltage by placing the leads on the jack. If no reading is displayed, a replacement battery is required. f. If step “a” does not correct issue, proceed to check all electrical terminals. If any loose connection is detected, firmly insert the plug into the electrical terminals. Also verify electrical connections between the control box and the siderails or footboard. g. To check the electrical connection between the Control Unit and Siderail Controls, locate the signal cable as shown in Step 2 of “Head Siderail Replacement”. h. If any cables are damaged, please contact Amico Beds CSR to request a replacement. (See “Replacement Parts List” for part number).

Troubleshooting

Item No.	Problem Descriptions	Troubleshooting Steps
3	CPR mechanism does not work: fowler does not lower when the CPR handle is pulled and weight is applied.	<ol style="list-style-type: none"> a. Using the electronic controls, raise fowler section completely to the upright position. b. Check the entire length of the CPR cable and note any areas that are pinched. If the cable is damaged in these areas, have the cable replaced immediately. c. Check the in-line and end-line cable adjustors for signs of loosening or damage. If the adjustors are loose, tighten them down. If the adjustors have been damaged, have them replaced immediately. d. If problem persists, please contact your Amico Sales Executive for support.
4	Patient hand pendant is not working	<ol style="list-style-type: none"> a. Press a button and check to see if the LED backlighting comes ON. If so, check to see if any Lock Out functions have been engaged. b. If there is no backlighting, unplug the pendant and plug it into the port on the opposite side of the bed frame. If the pendant works, please contact the Amico Beds CSR for support. c. If the pendant still does not work, please contact Amico Beds CSR to request a replacement. (See "Replacement Parts List" for part number).
5	Brakes do not engage	<ol style="list-style-type: none"> a. Remove base covers to access the brake mechanism. b. Check all bolted connections between the casters, linkages, and brake pedal. If there are any loose connections (e.g. bolts are wiggling, missing nuts) or disconnected linkages, retighten so that the bolts can only rotate freely. c. Verify that each caster is in Total Lock (no rotation, no swivel). If any casters are not locked, remove the caster and replace it with a new one. (See "Replacement Parts List" for part number). d. If the brakes still do not work, please contact Amico Beds CSR or your Amico Sales Executive for support.
6	Unintended motion is observed.	<ol style="list-style-type: none"> a. Check all siderail and footboard controls to determine if any of the buttons are being pressed unintentionally. b. If no buttons are visibly being pressed, remove the Footboard and verify if the motion still occurs. If motion ceases, the Footboard control is faulty and may need to be replaced (See "Replacement Parts List" for part number). c. If motion is still observed after Step "b", one of the Siderail Controls may be faulty. Allow the motion to complete (i.e. actuator has reached the end of the stroke), then proceed to Step 2 of the "Head Siderail Replacement" section of this manual. d. Remove one siderail first and check if functionality has been restored. If bed movement control has been restored, the removed siderail is faulty; otherwise, the other siderail is faulty. Replace the faulty siderail by following the "Head Siderail Replacement" section. (See "Replacement Parts List" for part number). e. If the steps above are followed and the problem persists, please contact Amico Beds CSR or your Amico Sales Executive for support.

Head Siderail Replacement

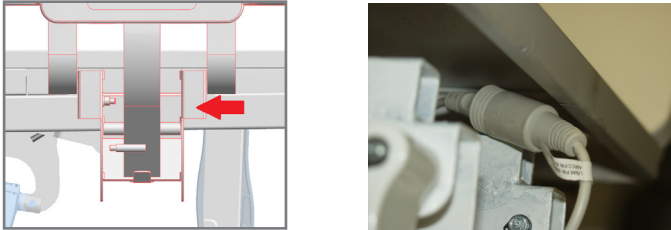
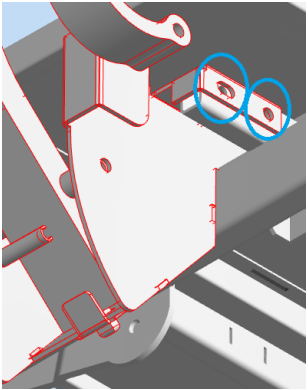

WARNING: Replacement of Siderail MUST be completed per the instructions below and only using Amico approved parts. Failure to comply may result in significantly-reduced effectiveness of the safety features of the system.

Step No.	Procedure	Illustrations
1	Locate Head Siderail that requires replacement. Make sure that replacement Head Siderail corresponds to the correct side of the bed.	
2	Disconnect the signal cable from the main harness. To disconnect the cable, remove the locking nut first.	
3	Locate the bolts holding the Head Siderail to the Fowler frame. Using a 1/2" (13 mm) wrench/socket, remove the bolts and pull the Head Siderail away from the Fowler.	
4	To install the new Head Siderail, perform the above steps in reverse. With the new Head Siderail plugged in, check that the buttons are working properly.	

Foot Siderail Replacement

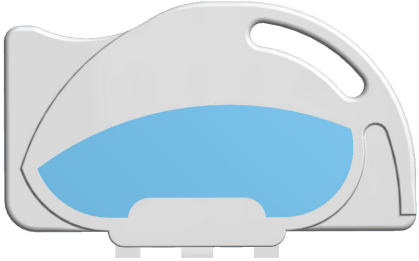
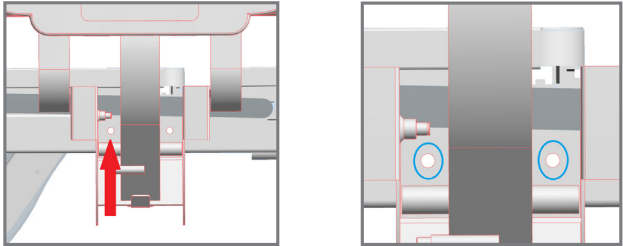
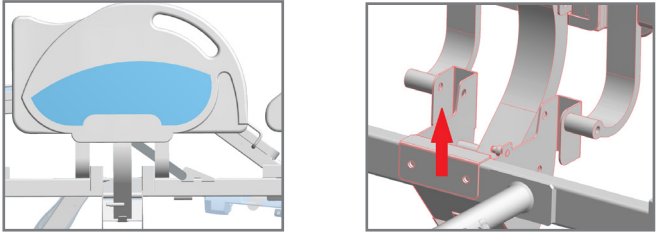

WARNING: Replacement of Siderail MUST be completed per the instructions below and only using Amico approved parts. Failure to comply may result in significantly-reduced effectiveness of the safety features of the system.

Step No.	Procedure	Illustrations
1	Locate Foot Siderail that requires replacement. Make sure that replacement Foot Siderail corresponds to the correct side of the bed.	
2	Locate the bolts holding the Foot Siderail to the Upper frame. Using a 1/2" (13 mm) wrench/socket, remove the bolts.	
3	Raise the Knee Section and remove the Foot Siderail by unhooking it from the Upper Frame.	
4	To install the new Foot Siderail, perform the above steps in reverse. With the new Foot Siderail plugged in, check that the buttons are working properly.	

Batteries



WARNING: The Battery is secured within an enclosure in the bed and can only be removed using tools. It is not necessary to remove the battery if the bed is not used for an extended period of time. If the Battery requires servicing or replacement, only facility-authorized service personnel should be allowed to remove it from the enclosure.

How to handle LINAK's rechargeable lead acid batteries to obtain the longest possible life. The below standing figure represents the relation between discharging depth and expected battery life, given in number of cycles.

Figure 1
Charging / Discharging Cycles

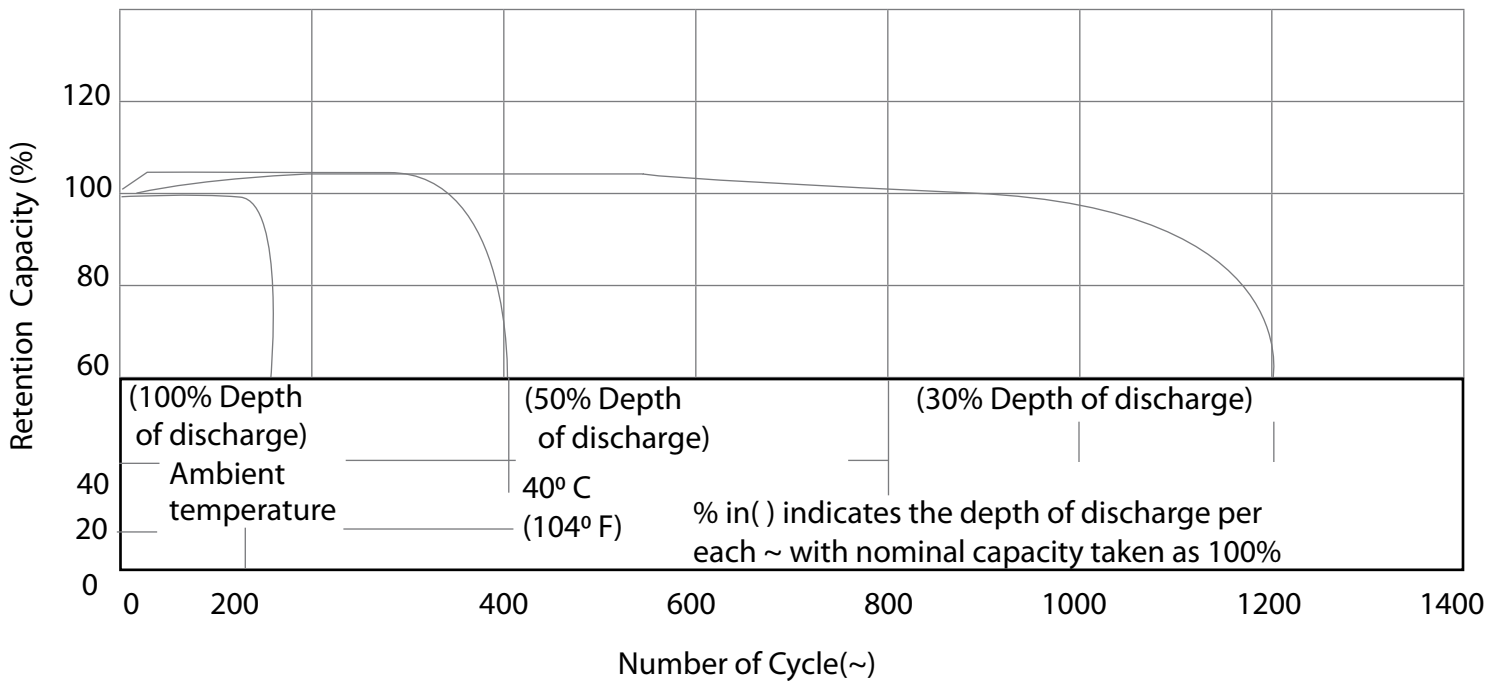

The curves can be explained as follows:

- 100% discharging depth - It appears from the curve that there are 180 cycles available at 100% discharging between charging.
- 50% discharging depth - It appears from the curve that there are 400 cycles available at 50% discharging between charging.
- 30% discharging depth - It appears from the curve that there are 1,200 cycles available at 30% discharging between charging.



WARNING: To attain the longest battery life, it is recommended to recharge the battery frequently and prevent it from discharging as much as possible.



WARNING: Remember always to have the control box plugged to the main power, thereby keeping the batteries fully charged all the time.

Control Boxes with Battery Back Up Only

Figure 2
Battery Capacity

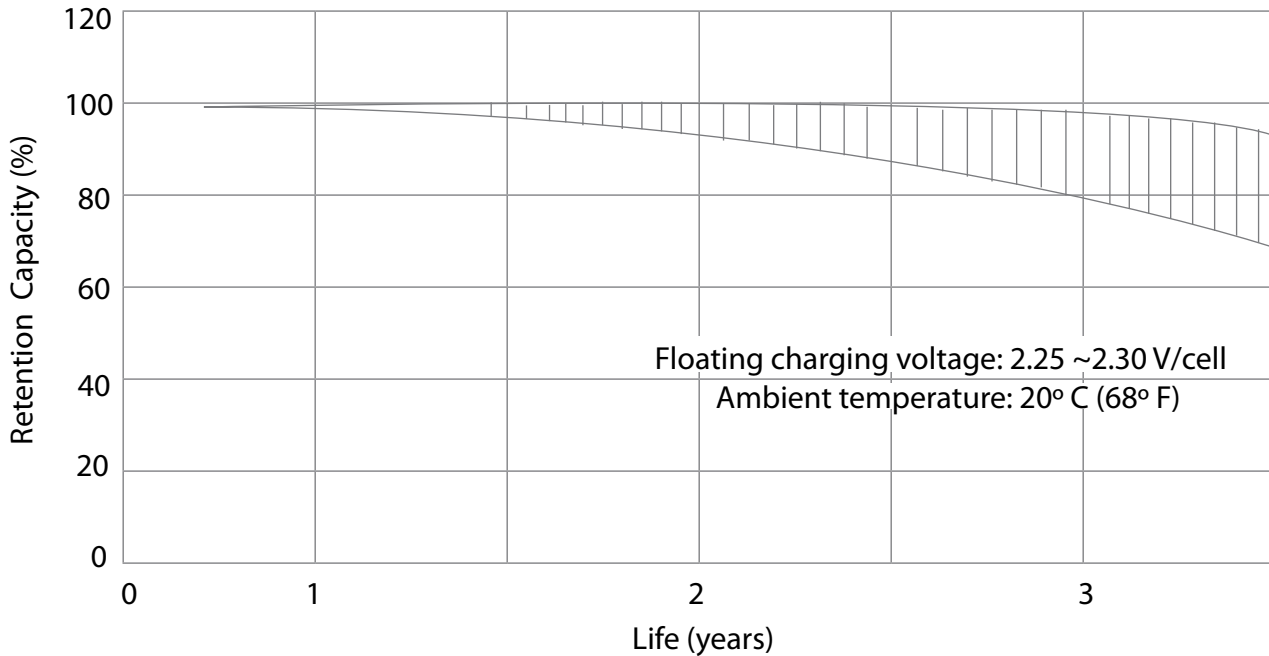

The above figure represents the battery capacity over time at 20°C at constant recharging and no consumption on the battery.

Please be aware that the battery's ability to retain 100% charge capacity will diminish over time, even if it is not being used. This will be evident after three or more years, where the battery will only be able to retain between 80 and 100% of its full capacity.

If the battery is used at a higher temperature than 20°C, the curve, representing the capacity of the battery over the time, is expected to fall even more.



WARNING: Because of the self-discharge, you cannot expect the batteries to be fully charged when they leave the factory. LINAK recommends that the customer charges the batteries immediately upon receipt or, at the latest, 5 months after LINAK's production date. The earlier the batteries are charged, the greater the chance of a longer battery life. The mentioned charging should last min. 24 - 48 hours and longer if possible.

Charging current:

Typical rule: Maximum charging current = 0.25 x battery capacity (Ah)
BAJ1/2 JUMBO: 0.25 x 2.9 = 0.7A
BA1800: 0.25 x 1.2 = 0.3A

Charging voltage:

24 V system: Maximum 27.60 V

Control Boxes with Battery Back Up Only

The charging current/time by use of the battery back-up.

Example BA1800: Maximum charging current = $0.25 \times$ battery capacity (Ah)

BA1800: $0.25 \times 1.2 =$ Approximately 0.3 A.

Charging time: Approximately 1.2 Ah : 0.3 A = Approximately 4 - 5 hours.

Example BAJ1/2: Maximum charging current = 0.25×2.9 Ah = Approximately 0.7 A

Charging time: Approximately 2.9 Ah : 0.7 A = 4 - 5 hours

Please observe the curve below or see further information regarding battery characteristics in **Figure 1 and 2**.

Charging characteristics:

- In theory, if the battery capacity is approximately 0% it takes about 4 - 5 hours to reach 80% of the battery capacity level.
- We recommend a charging time up to approximately 10 hours which gives 100% capacity.
- At 100% capacity the battery will not discharge as quickly as it would at 80% capacity.
- The internal and external battery charging characteristics are identical.
- The battery alarm on a LINAK CB will activate at approximately 18 V. The charging of the battery must be started before reaching this level to maintain as long a battery life as possible.
- We therefore recommend you always to have the control box plugged to the main power, to keep the batteries fully charged.

80% capacity ~ up to 4 - 5 hours charging time depending on the level of discharging

100% capacity ~ up to 10 hours charging time depending on the level of discharging

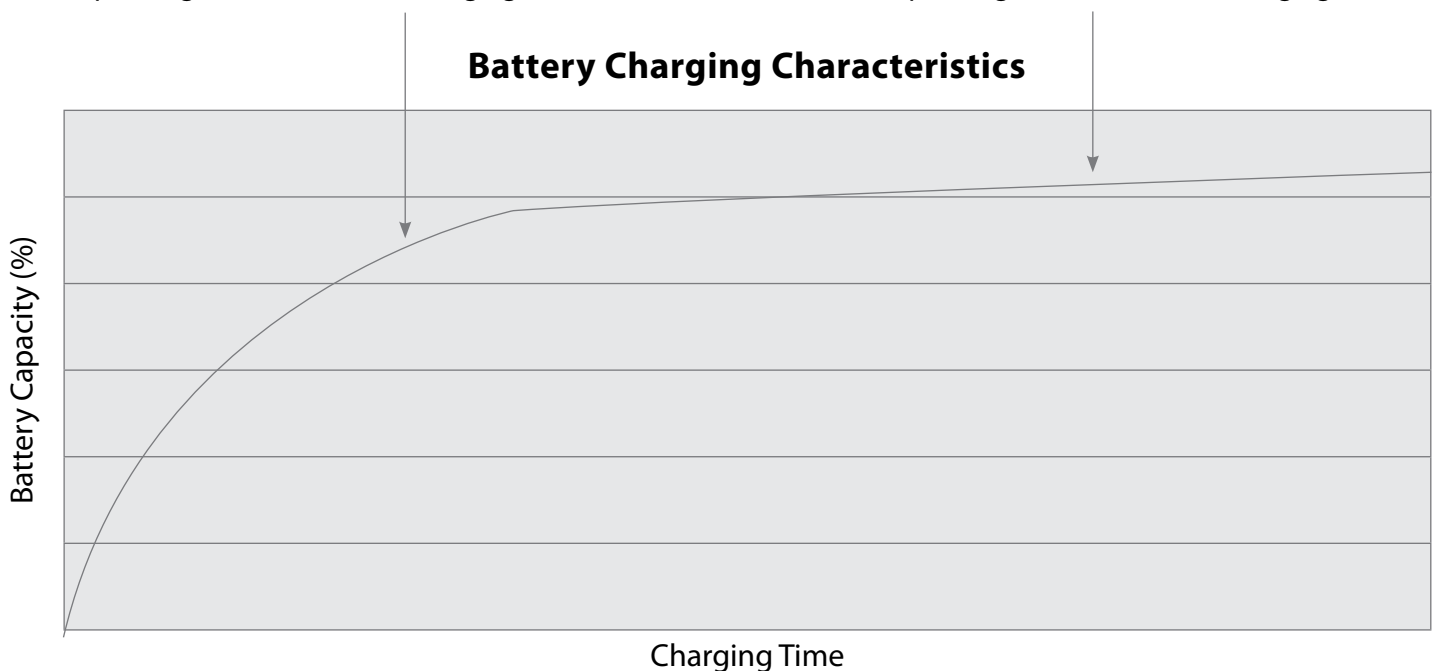

Control Boxes with Battery Back Up Only

We recommend you to discharge the batteries as little as possible to optimize the battery life. The discharging time and the level of the battery capacity depends on the load characteristics of the application and the way in which the battery is used.



WARNING: It is not prohibited to use batteries that are not from LINAK's product range as this will result in overloading LINAK's battery charger.

If replacement batteries are required, please contact Amico Beds CSR for support. (See "Replacement Parts List" for part number)

Specifications are subject to change without prior notice
LINAK SALES BACK-UP
1st edition rev. 2001-03-01

Components List

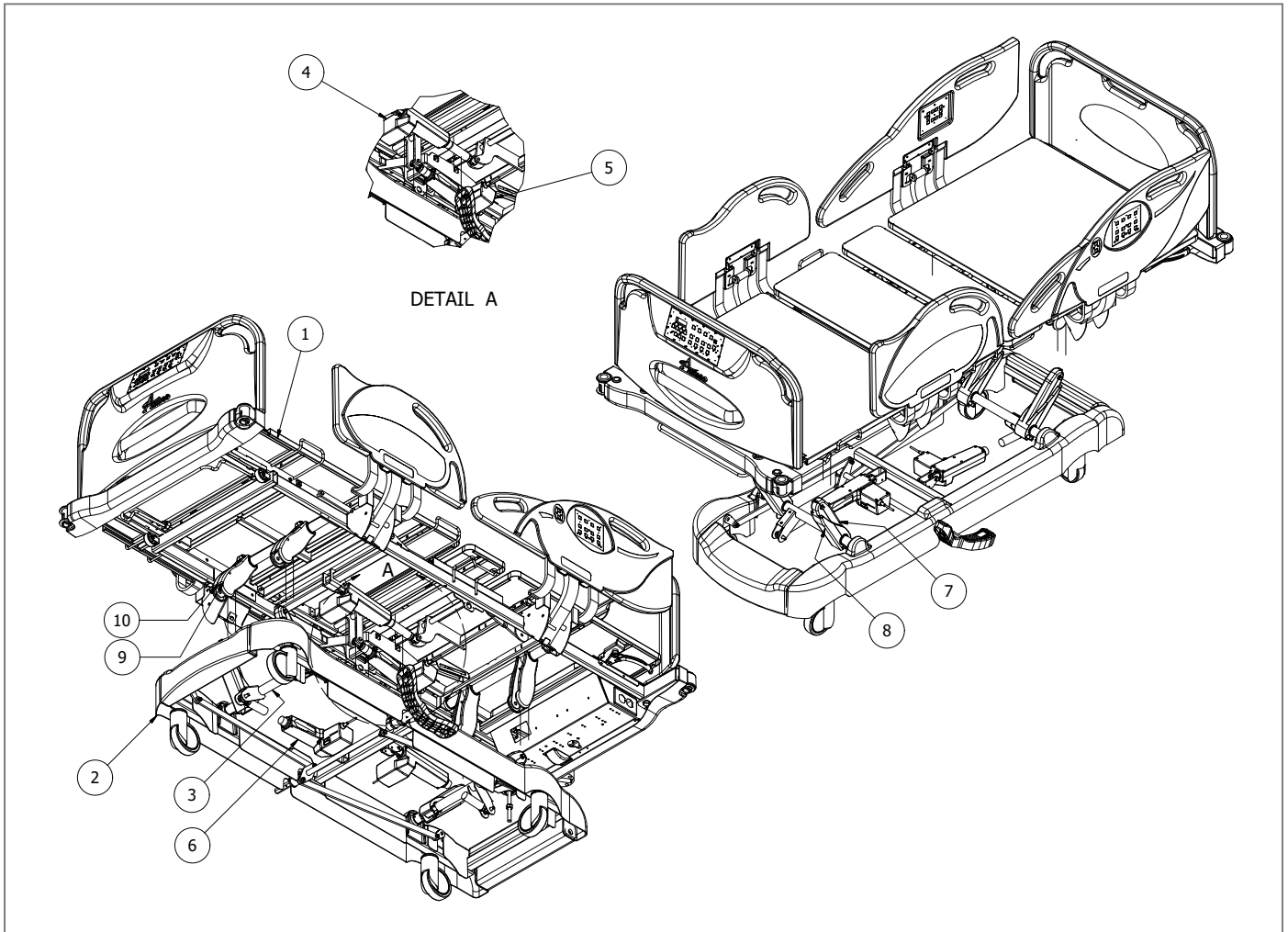

Item No.	Quantity	Part Number	Description
1	1	B-400-UPPER-ASSY	Upper Assembly
2	1	B-400-LOWER-ASSY	Lower Assembly
3	2	B-X-HILO-LARMS	Lower Hi-Lo Arms
4	1	B-X-ACT-01-FOWLER	Linak Fowler Actuator
5	1	B-X-ACT-01-KNEE	Linak Knee Actuator
6	2	B-X-ACT-01-HILO	Linak Hi-Lo Actuator
7	4	B-PCOVER-LARMS-001	Lower Long Arm Cover - Top
8	4	B-PCOVER-LARMS-002	Lower Long Arm Cover - Bottom
9	4	B-PCOVER-UARMS-001	Lower Long Arm Cover - Left
10	4	B-PCOVER-UARMS-002	Lower Long Arm Cover - Right

Components List

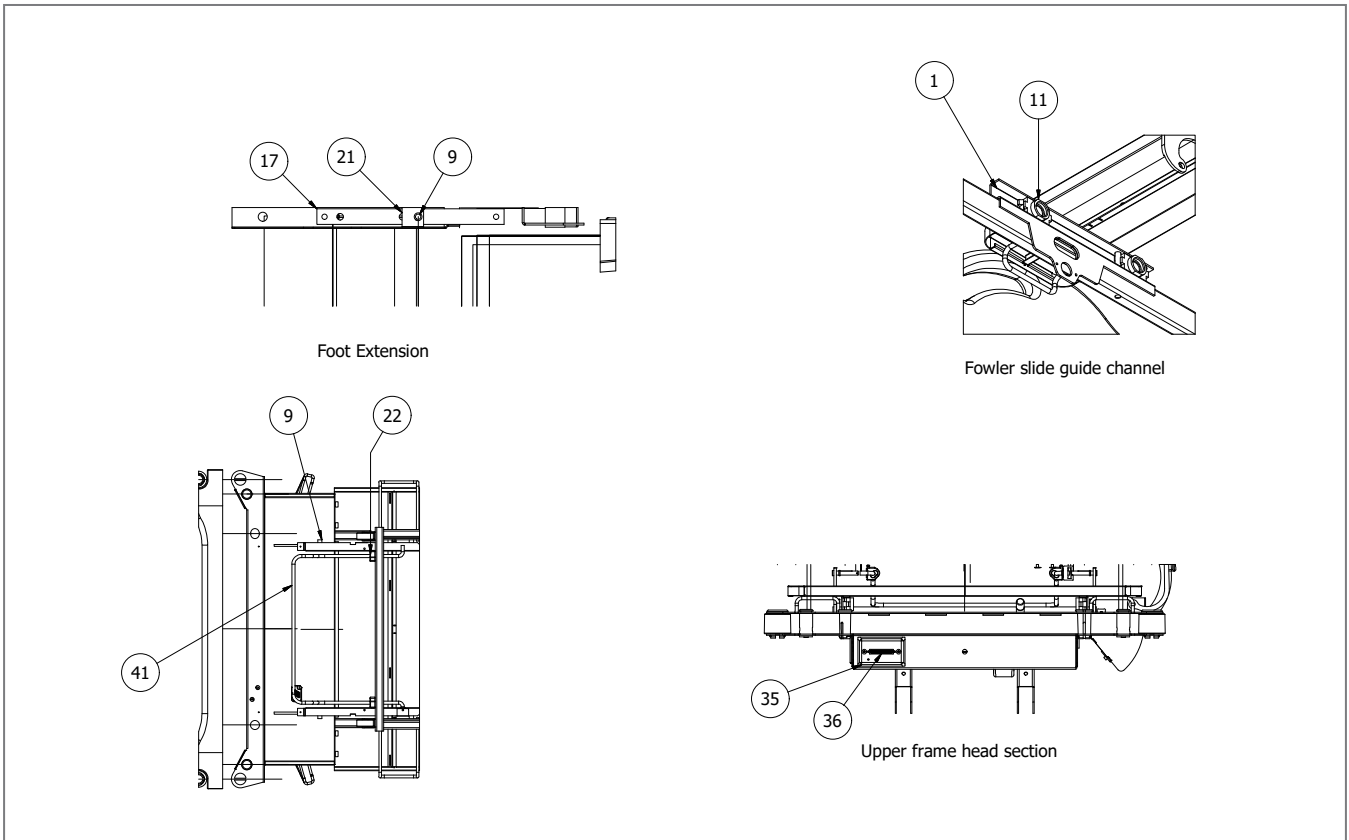
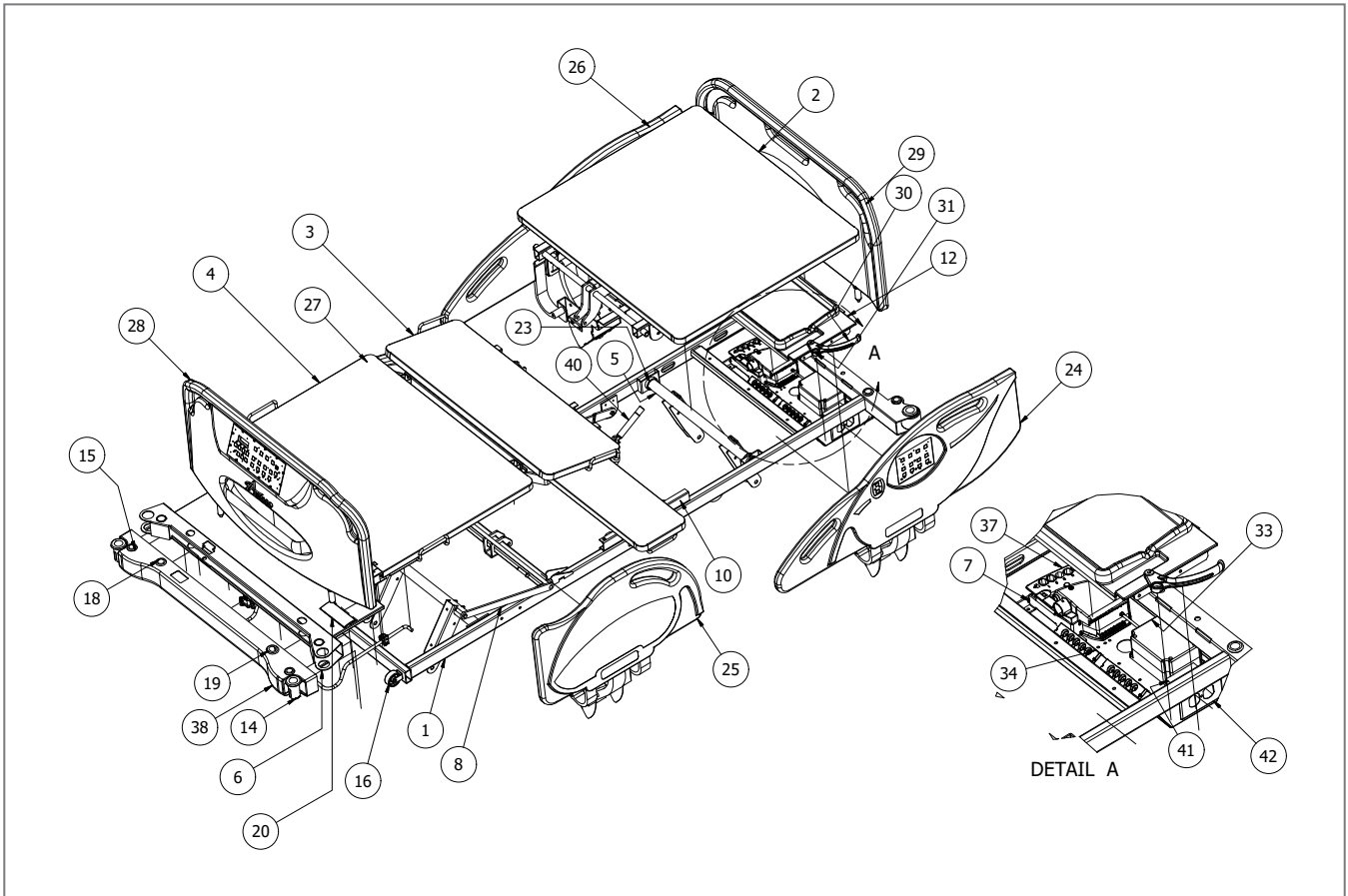

Components List

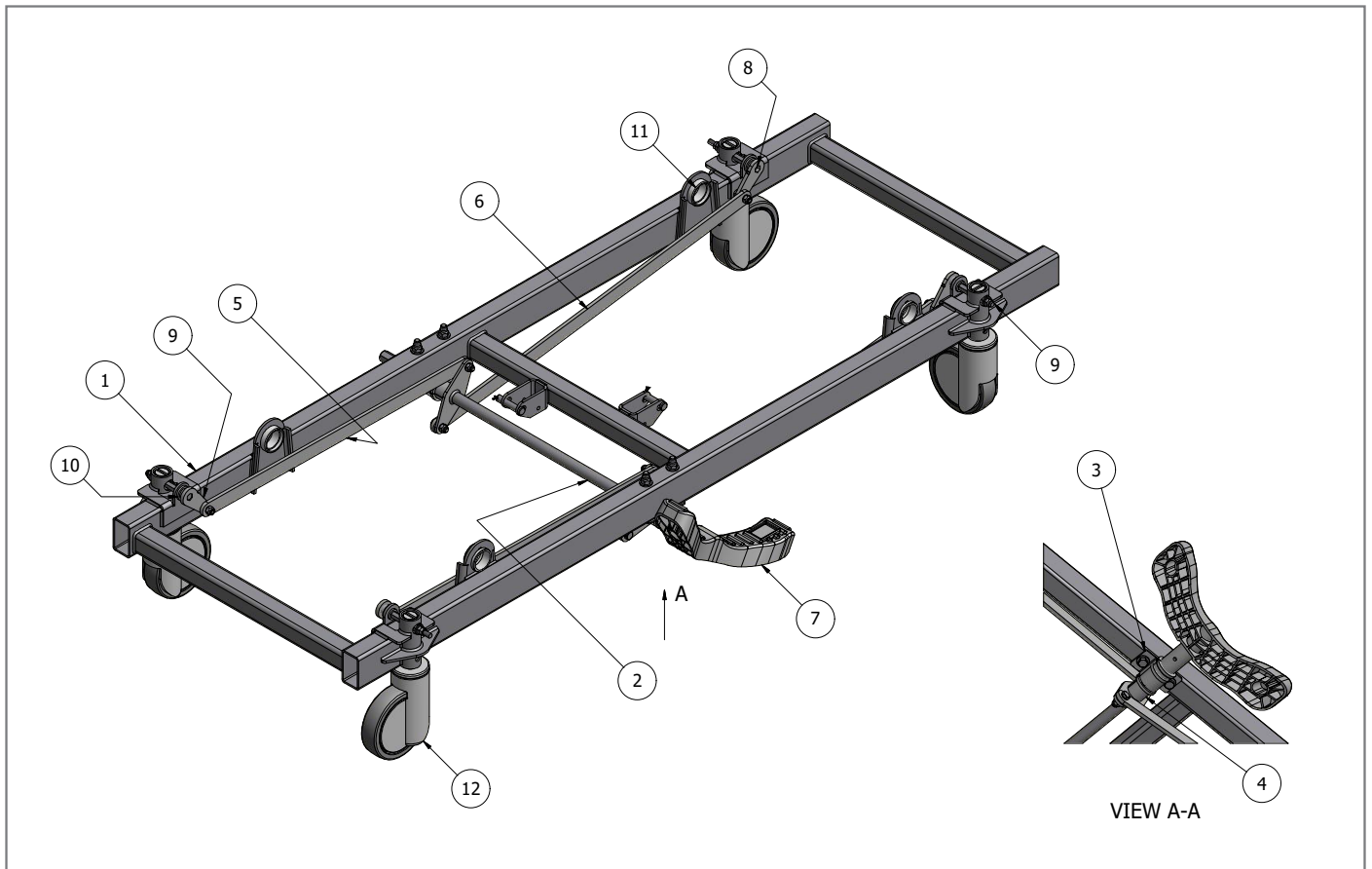

Item No.	Quantity	Part Number	Description
1	1	B-X-FRAME-UPPER	Upper Frame
2	1	B-X-FOWLER	Fowler
3	1	B-X-KNEE	Knee Section
4	1	B-X-FOOT	Foot Section
5	1	B-X-HILO-UARMS	Upper Hi-Lo Arms
6	1	B-X-FOOTEXT	Foot Extension
7	1	B-X-CTRLUNIT-BRKT	Control Box Bracket
8	1	B-X-FOOTFORK	Foot Fork
9	2	B-X-FOOT-013	Spacer
10	2	B-X-FOWLER-LINK	Fowler Link Bar
11	4	B-X-PGUIDE-FOWLER	Fowler Guide Plastic
12	1	B-X-CTRBOXCVR	Control Unit Cover
13	2	B-X-BUMPER-ROLLER	Roller Bumper
14	4	B-X-PBUSHING-ETS	ETS Plastic Bushing
15	4	S-X-PBUSHING-IVPOLE	IV Pole Plastic Insert
16	2	B-X-FOOT-ROLLER	Foot Roller
17	2	B-X-FOOT-SLIDER	Slide Plate
18	2	B-X-PBUSHING-FB	Footboard Plastic Insert
19	2	B-X-PBUSHING-FB-SL	Footboard Plastic Insert - Slotted
20	5	B-X-SEAMCOVER	Foot Extender Seam Cover
21	4	B-X-PGUIDE-SLIDE	Slide Guide Plastic
22	2	B-X-PGUIDE-FOOTEXT	Foot Extension Lock Guide Plastic
23	2	B-X-PBUSHING-HILO	Hi-Lo Bushing
24	1	B-400-SRAIL-LHEAD	Siderail - Head Left
25	1	B-4000-SRAIL-LFOOT	Siderail - Foot Left
26	1	B-4000-SRAIL-RHEAD	Siderail - Head Right
27	1	B-4000-SRAIL-RFOOT	Siderail - Foot Right
28	1	B-FOOTBOARD	Footboard
29	1	B-HEADBOARD	Headboard
30	2	B-X-CPRHAND	CPR Handle
31	2	B-X-CPRNUT	CPR Release Nut
32	1	C-0211758-01-3	Foot Connector
33	1	B-X-BATTERY-01	Linak Battery Unit
34	2	B-X-MJB-01	Linak MJB
35	1	Cover Plate D-Sub	
36	1	C-0205209-07-3	
37	1	B-X-CTRLUNIT-01	Linak Control Unit
38	1	B-X-ENDCVR-FOOT	Foot End Cover
39	1	B-X-ENDCVR-HEAD	Head End Cover
40	1	B-X-GASSPRING-900	Gas Spring
41	1	B-X-FOOTEXT-LOCK	Foot Extension Lock Bar

Components List

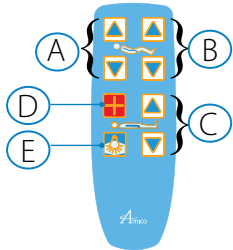

Item No.	Quantity	Part Number	Description
1	1	B-X-FRAME-LOWER	Lower Frame
2	1	B-X-BRAKE-SHAFT	Brake Shaft
3	2	B-X-BRAKE-BUSHCRDL	Brake Shaft Bushing Cradle
4	4	B-X-PBUSHING-BRAKE	Brake Shaft Bushing
5	2	S-X-BRAKE-LINK-SH	Brake Linkage - Short
6	2	B-X-BRAKE-LINK-LG	Brake Linkage - Long
7	1	S-X-BRAKE-PEDALP	Brake Pedal
8	2	B-X-BRAKE-CASTARM	Brake Caster Arm
9	2	B-X-BRAKE-CASTARM-MIR	Brake Caster Arm (Mirrored)
10	4	B-X-PBUSHING-CASTARM	Caster Arm Bushing
11	4	B-X-PBUSHING-HILO	Hi-Lo Arm Bushing
12	3	B-CAS-UNI-05B1	Bed Tente Caster 5"
13	1	B-CAS-DIR-05B1	Bed Tente Caster 5"
14	1	B-X-BASECVR-FOOT	Base Cover - Foot
15	1	B-X-BASECVR-LEFT	Base Cover - Left Side
16	1	B-X-BASECVR-RIGHT	Base Cover - Right Side
17	1	B-X-BASECVR-HEAD	Base Cover - Head

Accessories List



Accessories Image	Description and Part Number	How to Use
	<p>Foldable IV Pole B-FOLDIV</p>	<p>To Use</p> <ul style="list-style-type: none"> • Lift the IV Pole from the folded position behind the headboard. • Allow the IV Pole to drop into its base support. This will lock the pole in the upright position. • Raise the IV Pole by grasping the telescopic section with one hand and loosening the coupler with the other hand. • Once the desired height is reached, tighten the coupler and the IV Pole is ready to use. <p>To Store:</p> <ul style="list-style-type: none"> • Grasp the telescopic section with one hand and loosen the coupler with the other hand. • Lower the telescopic section until fully collapsed, then tighten the coupler. • Pull the pole upwards to lift it out of the base support. • Rotate the pole down to the folded position behind the headboard. • The pole should come to a rest in the IV Pole support mounted on the frame. <p>⚠ CAUTION: Do not exceed the 30 lbs max weight capacity.</p>
	<p>Patient hand pendant B-X-HANDSET-02</p>	<p>A - Head Section(Fowler)UP/DOWN B - Knee Section UP/DOWN C - Bed Height UP/DOWN D - Nurse Call E - Toggle Underbed Light ON/OFF</p>
	<p>Mattress Please contact Amico Beds for more information</p>	<p>⚠ WARNING: Mattress dimensions must not be smaller than 84" long x 36" wide x 6" thick. Failure to adhere to these dimensions may result in non-compliance to entrapment guidelines as outlined by IEC 60601-2-38, thus increasing the risk of patient injury or death.</p>
	<p>Removable I.V. Pole (optional) S-X-IVPOLE-R</p>	<p>To Install</p> <ul style="list-style-type: none"> • Locate the IV Pole plastic insert at any of the 4 corners of the bed. • Insert the base of the IV Pole into the hole. <p>To Use</p> <ul style="list-style-type: none"> • Raise the IV Pole by grasping the telescopic section with one hand and loosening the knob with the other hand. • Once the desired height is reached, tighten the knob and the flip down the hooks. <p>To Remove</p> <ul style="list-style-type: none"> • Flip up all of the hooks and lower the telescopic section. • Grasp the main body of the IV Pole and pull up to remove the entire pole. <p>⚠ CAUTION: Do not exceed the 15 lbs max weight capacity.</p>

NOTE: The accessories above are only for use with the Apollo MS bed. It is NOT recommended to use accessories that are not designed for the Apollo MS bed. Failure to comply could result in personal injury or equipment damage, and may void the product's warranty.





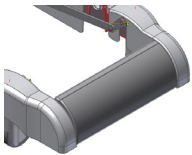
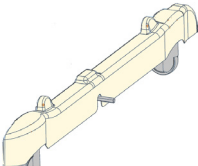
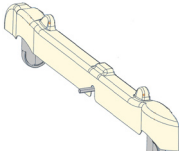
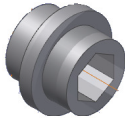
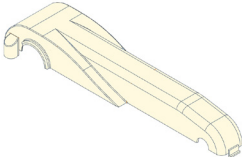
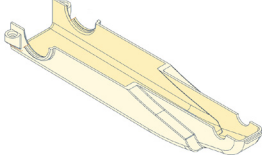
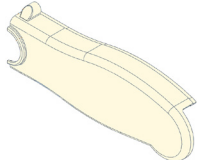
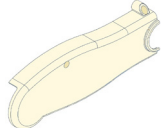

Replacement Parts List

Part Image	Part Description	Part Number
	Roller Bumper	B-X-BUMPER-ROLLER
	ETS Plastic Bushing	B-X-PBUSHING-ETS
	IV Pole Plastic Insert	S-X-PBUSHING-IVPOLE
	FB Plastic Insert	B-X-PBUSHING-FB
	FB Plastic Insert - Slotted	B-X-PBUSHING-FB-SL
	Footboard PCB Support	B-X-SUPPCB-FOOT-VER3
	Foot Extender Seam Cover	B-X-SEAMCOVER
	Control Unit Cover	B-X-CTRBOXCVR
	Base Cover - Foot	B-X-BASECVR-FOOT

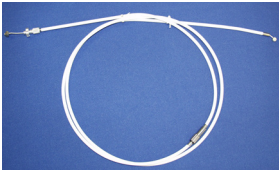

Replacement Parts List

Part Image	Part Description	Part Number
	Base Cover - Head	B-X-BASECVR-HEAD
	Base Cover - Right Side	B-X-BASECVR-RIGHT
	Base Cover - Left Side	B-X-BASECVR-LEFT
	Caster Arm Bushing	B-X-PBUSHING-CASTARM
	Lower Long Arm Cover - Top	B-PCOVER-LARMS-001
	Lower Long Arm Cover - Bottom	B-PCOVER-LARMS-002
	Upper Long Arm Cover - Left	B-PCOVER-UARMS-001
	Upper Long Arm Cover - Right	B-PCOVER-UARMS-002
	Siderails - Head Left	B-4000-SRAIL-LHEAD
	Siderails - Foot Left	B-4000-SRAIL-LFOOT

Replacement Parts List

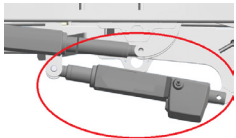

Part Image	Part Description	Part Number
	Siderails - Head Right	B-4000-SRAIL-RHEAD
	Siderails - Foot Right	B-4000-SRAIL-RFOOT
	Tente© Caster 5" Total Lock Unidirectional	B-CAS-UNI-05B1
	Tente© Caster 5" Total Lock Directional	B-CAS-DIR-05B1
	Brake Pedal	S-X-BRAKE-PEDALP
	Foot Roller	B-X-FOOT-ROLLER
	Footboard	B-FOOTBOARD
	CPR Release Cable	B-CPR-CABLEASSY
	Head End Cover	B-X-ENDCVR-HEAD
	Foot End Cover	B-X-ENDCVR-FOOT

Replacement Parts List

Part Image	Part Description	Part Number
	Fowler Gas Spring	B-X-GASSPRING-400
	Siderail Plate Cover	
	Siderail Middle Linkage Covers	
	LINAK DC Actuator – Fowler	B-X-ACT-01-FOWLER
	LINAK DC Actuator – Knee	B-X-ACT-01-KNEE
	LINAK DC Actuator – Hi-Lo	B-X-ACT-01-HILO

NOTE: If you require a part that does not appear in the “Replacement Parts List” please contact your Amico Sales Executive for assistance.

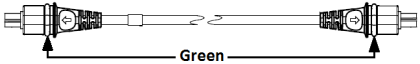
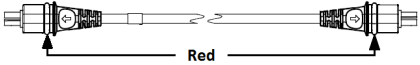
Cables

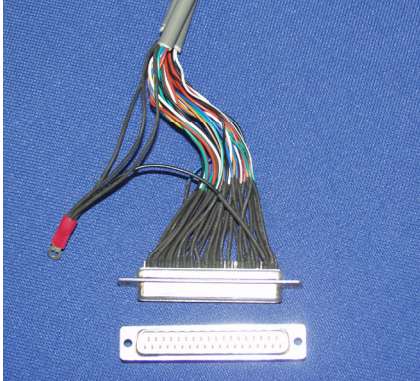
Cable Image	Cable Description	Part Number
	LINAK – Footboard Cable	B-X-CABLE-HB
	LINAK – Extension Cable – Green O-Ring	B-X-CABLE-EXTENSION-G
	LINAK – Extension Cable – Red O-Ring	B-X-CABLE-EXTENSION-R
	Power Supply Cord (120V) 126" long cord w/12" pigtail for Grounding	H-X-PCORD-10-NA
	37-pin Nurse Call Connector 72" long	B-X-CBL-37PIN-06



WARNING: It is NOT recommended to use cables that are not designed for the B-AM1-400X bed. Failure to comply could result in personal injury or equipment damage, and may void the product's warranty.

Electromagnetic Compatibility

This product conforms to the EMC standard IEC 60601-1-2 (3rd Edition).

NOTE:

- This product needs special precautions regarding EMC and needs to be installed and put into service according to the EMC information provided below.
- Mobile RF communications equipment can affect the product.
- The use of accessories and cables other than those supplied with the product as replacement parts, with exception for cables sold by Amico Beds Corporation, may result in increased emission or decreased immunity of the product.
- This product should not be used adjacent to or stacked with other equipment. If adjacent or stacked use is necessary, the product should be observed to verify normal operation in the configuration in which it will be used.

Table A.1 – Electromagnetic Emissions

The Apollo Bed (B-AM1-400X) is intended for use in the electromagnetic environment specified below. The customer or user of B-AM1-400X should assure that it is only used in such an environment.		
Emission Test	Compliance	Electromagnetic Environment – Guidance
RF Emissions CISPR11	Group 1	The Apollo Bed (B-AM1-400X) uses RF energy only for its internal function. Therefore, its RF emissions are very low and are not likely to cause any interference in nearby electronic equipment. The Apollo Bed (B-AM1-400X) is suitable for use in all establishments other than domestic and those directly connected to public low voltage power supply network that supplies buildings used for domestic purposes.
RF Emissions CISPR11	Class A	
Harmonic Emission IEC 61000-3-2	Not Applicable	
Voltage Fluctuation/Flicker Emission IEC 61000-3-3	Not Applicable	

Electromagnetic Compatibility

Table A.2 – Electromagnetic Immunity

The Apollo Bed (B-AM1-400X) is intended for use in the electromagnetic environment specified below. The customer or user of B-AM1-400X should assure that it is only used in such an environment.			
Immunity Test	IEC 60601 Test Level	Compliance Level	Electromagnetic Environment – Guidance
Electrostatic Discharge (ESD) IEC 61000-4-2	± 6 kV contact ± 8 kV air	± 6 kV contact ± 8 kV air	Floors should be wood, concrete or ceramic tile. If floors are covered with synthetic material, the relative humidity should be at least 30%.
Electrical fast transient/burst IEC 61000-4-4	± 2 kV for power supply lines ± 1 kV for input/output lines	± 2 kV for power supply lines ± 1 kV for input/output lines	Main power quality should be that of a typical commercial or hospital environment.
Surge IEC 61000-4-5	± 1 kV line(s) to line(s) ± 2 kV line(s) to earth	± 1 kV differential mode ± 2 kV common mode	Main power quality should be that of a typical commercial or hospital environment.
Voltage dips, short interruptions and voltage variations on power supply input lines IEC 61000-4-11	<5% U _Y (>95% dip in U _Y) for 0.5 cycle 40% U _Y (60% dip in U _Y) for 5 cycle 70% U _Y (30% dip in U _Y) for 25 cycle <5% U _Y (>95% dip in U _Y) for 5 s	<5% U _Y (>95% dip in U _Y) for 0.5 cycle 40% U _Y (60% dip in U _Y) for 5 cycle 70% U _Y (30% dip in U _Y) for 25 cycle <5% U _Y (>95% dip in U _Y) for 5 s	Main power quality should be that of a typical commercial or hospital environment. If the user of the Apollo Bed (B-AM1-400X) requires continued operation during main power interruptions, it is recommended that the Apollo Bed (B-AM1-400X) be powered from an uninterrupted power supply or a battery.
Magnetic field at power frequency IEC 61000-4-8	3 A/m	3 A/m	Power frequency magnetic fields should be at levels characteristic of a typical location in a typical commercial or hospital environment.

NOTE: U_Y is the A.C. main voltage prior to application of the test level.

NOTE: This medical device is a patient support and handling device with an electro-mechanical system, able to achieve various heights and positions for the litter sections as required per the end user. The device meets this essential performance at the above compliance levels.

Electromagnetic Compatibility

Table A.3 – Electromagnetic Immunity

The Apollo Bed (B-AM1-400X) is intended for use in the electromagnetic environment specified below. The customer or user of B-AM1-400X should assure that it is only used in such an environment.			
Immunity Test	IEC 60601 Test Level	Compliance Level	Electromagnetic Environment – Guidance
			Portable and mobile RF equipment should be used no closer to any part of the B-AM1-400X (including cables) than the recommended separation distance calculated from the equation applicable to the frequency of the transmitter. Recommended separation distance:
Conducted RF IEC 61000-4-6	3 Vrms (from 150 kHz to 80 MHz)	3 Vrms	$d = 1.2 \times \sqrt{P}$ from 150 kHz to 80 MHz
Radiated RF IEC 61000-4-3	3 V/m (from 80 kHz to 2.5 GHz)	3 V/m	$d = 1.2\sqrt{P}$ (for 80MHz to 800 MHz) $d = 2.3\sqrt{P}$ (for 800 MHz to 2.5 GHz)
			<p>P is the maximum output power rating of the transmitter in watts (W) according to the transmitter manufacturer and d is the recommended separation distance in metres (m).^b</p> <p>Field strengths from fixed RF transmitters, as determined by an electromagnetic Site survey^a, should be less than the compliance level in each frequency range^b.</p> <p>Interference may occur in the vicinity of equipment marked with the following symbol:</p> 
<p>NOTE 1: At 80 MHz and 800 MHz, the higher frequency range applies.</p> <p>NOTE 2: These guidelines may not apply in all situations. Electromagnetic propagation is affected by absorption and reflection from structures, objects, and people.</p> <p>^a: Field strengths from fixed transmitters such as base stations for radio (cellular/cordless) telephones and land mobile radios, amateur radio, AM and FM radio broadcast and TV broadcast cannot be predicted theoretically with accuracy. To assess the electromagnetic environment due to fixed RF transmitters, an electromagnetic site survey should be considered. If the measured field strength in the location in which the Apollo Bed (B-AM1-400X) is used exceeds the applicable RF compliance level above, the Apollo Bed (B-AM1-400X) should be observed to verify normal operation. If abnormal performance is observed, additional measures may be necessary, such as re-orienting or relocating the Apollo Bed (B-AM1-400X).</p> <p>^b: Over the frequency range 150 kHz to 80 MHz, field strengths should be less than 3 V/m.</p>			

Electromagnetic Compatibility

Table A.4 – Recommended Separation Distances

Recommended separation distances between portable and mobile RF communications equipment and the Apollo Bed (B-AM1-400X).

The Apollo Bed (B-AM1-400X) is intended for use in the electromagnetic in which radiated RF disturbances are controlled. The customer or user of the Apollo Bed (B-AM1-400X) can help prevent electromagnetic interference by maintaining a minimum distance between portable and mobile RF communications equipment (transmitters) and the Apollo Bed (B-AM1-400X) as recommended below, according to the maximum output power of the communications equipment.

Rated Maximum Output Power of Transmitter (W)	Separation Distance According to the Frequency of Transmitter (m)		
	from 150kHz to 80MHz $d= 1.2 \times \sqrt{P}$	from 80MHz to 800MHz $d= 1.2 \times \sqrt{P}$	from 800MHz to 2,5GHz $d= 2.3 \times \sqrt{P}$
0.01	0.12	0.12	0.23
0.1	0.38	0.38	0.73
1	1.2	1.2	2.3
10	3.8	3.8	7.3
100	12	12	23

For the transmitters rated at a maximum output power not listed above, the recommended separation distance d in meters (m) can be estimated using the equation applicable to the frequency of the transmitter, where P is the maximum output power rating of the transmitter in Watts (W) according to the transmitter manufacturer.

NOTE 1: At 80 MHz and 800 MHz, the separation distance for the higher frequency range applies.

NOTE 2: These guidelines may not apply in all situations. Electromagnetic propagation is affected by absorption and reflection from structures, objects and people.

EMI Information (FCC)

This device complies with Part 15 of the FCC Rules. Operation is subject to the following two conditions:

(1) this device may not cause harmful interference, and (2) this device must accept any interference received, including interference that may cause undesired operation.

NOTE: This equipment has been tested and found to comply with the limits for a Class A digital device, pursuant to Part 15 of the FCC Rules. These limits are designed to provide reasonable protection against harmful interference when the equipment is operated in a commercial environment. This equipment generates, uses and can radiate radio frequency energy and, if not installed and used in accordance with the instruction manual, may cause harmful interference to radio communications. Operation of this equipment in a residential area is likely to cause harmful interference in which case the user will be required to correct the interference at his own expense.



WARNING: Changes or modifications not expressly approved by Amico Beds Corporation could void the user's authority to operate the equipment.

Warranty

Amico Beds Corporation warrants its Patient Equipment to be free from defects in material and workmanship for a period of twelve (12) months from the date of shipment. Within this period Amico Beds Corporation will provide the parts for repair or replacement of defective parts at Amico Beds Corporation cost.

Shipping and Installation costs after the first twelve (12) months will be borne by the Customer.

This warranty is valid only when the product has been properly installed according to Amico Beds Corporation specifications, used in a normal manner and serviced according to factory recommendations. It does not cover failures due to damage which occurs in shipments or failures which result from accidents, misuse, abuse, neglect, mishandling, alteration, misapplication or damage that may be attributable to acts of God.

Amico Beds Corporation shall not be liable for incidental or consequential damages resulting from the use of the equipment.

Notes

www.amico.com

Amico Beds Corporation | 85 Fulton Way, Richmond Hill, ON L4B 2N4, Canada
Toll Free Tel: 1.877.462.6426 | Tel: 905.764.0800 | Fax: 905.764.0862
Email: info@amico.com | www.amico.com