

Operation & Maintenance Manual

Apollo MS-SC



Amico

Table of Contents

| | |
|--|--------------|
| Specifications | 3-4 |
| Description of Symbols | 5 |
| Warnings | 6-7 |
| Intended Use | 7 |
| Introduction | 7 |
| Features | 8 |
| Siderail & Footboard Controls | 9 |
| Siderail Controls | 10 |
| Footboard Controls | 11-12 |
| Central Locking System | 13 |
| Installation and Removal of the Head/Footboards | 14 |
| Siderails | 14-15 |
| Electrical | 15 |
| Preventive Maintenance | 16 |
| Cleaning Procedures | 17 |
| Cable Schematic | 18 |
| Troubleshooting | 19-24 |
| Head Siderail Replacement | 25 |
| Foot Siderail Replacement | 26 |
| Batteries | 27 |
| Control Boxes with Battery Back Up Only | 28-30 |
| Components List | 31-34 |
| Accessories List | 35 |
| Replacement Parts List | 36-39 |
| Cables | 40 |
| Electromagnetic Compatibility | 41-44 |
| Warranty Policy | 45 |
| Notas | 46-47 |

Specifications

| Model Number | Model Identification/Description | |
|---|-------------------------------------|----------------|
| B-AM1-4002 | Apollo MS-SC (MedSurg Bed) | |
| Feature | Dimension (inches) | Dimension (cm) |
| Total Length | 92 | 234 |
| Maximum Width | 42 | 107 |
| Mattress to Siderail Height | 9 | 23 |
| Maximum Under Bed Clearance | 6 | 15 |
| <i>Surface Dimensions</i> | | |
| Surface Width | 35 | 89 |
| Surface Length | 84 | 213 |
| Surface Mattress Thickness | 6 | 15 |
| <i>Litter Section</i> | | |
| Fowler Length | 32.5 | 83 |
| Fowler Width | 34 | 86 |
| Seat Length | 6 | 15 |
| Seat Width | 34 | 86 |
| Knee Gatch Length | 12.25 | 31 |
| Knee Gatch Width | 34 | 86 |
| Foot Section Length | 25 | 64 |
| Foot Section Width | 34 | 86 |
| Caster Size | 5 inches diameter | 13 cm diameter |
| Bed Lift Capacity (Safe Working Load) | 550 lbs max. | 250 kg max. |
| Total Weight without Surface | 450 lbs max. | 204 kg max. |
| Head Section Inclination (maximum) | 60 ± 5 degrees | |
| Knee Section Inclination (maximum) | 25 ± 5 degrees | |
| Bed Height Range, Lowest Position* | 15.5 | 40 |
| Bed Height Range, Highest Position* | 27 | 69 |
| Trendelenburg Position (max) | 12 degrees ± 1 | |
| Reverse Trendelenburg Position (max) | 12 degrees ± 1 | |
| AC Power Requirements | | |
| Voltage (Volts) | 120 max. | |
| Current (Amps) | 6.0 max. | |
| Frequency (Hertz) | 50/60 | |
| Duty Cycle | | |
| Continuous Operation w/ Intermittent Load | 10%, Max 2 min. LOAD / 18 min. REST | |
| Patient Characteristics | Dimension (inches) | Dimension (cm) |
| Height | 88 maximum | 224 maximum |
| Width | 36 maximum | 91 maximum |
| Weight | 350 lbs. | 159 kgs. |

Specifications

| Classification and Standards | |
|--|------------------------------------|
| UL 60601-1, | |
| CSA C22.2 No 601.1-M90, | |
| IEC 60601-1-2-38 | |
| Equipment Classification | Class 1, Type B |
| Environmental Conditions for Transport and Storage | |
| Temperature | -40 °F to 158 °F (-40 °C to 70 °C) |
| Relative Humidity | 95% non-condensing |
| Pressure | 50 KPa to 106 KPa |
| Environmental Conditions for Use | |
| Temperature | 50 °F to 95 °F (10 °C to 35 °C) |
| Relative Humidity | 20% to 85% non-condensing |
| Pressure | 70 KPa to 106 KPa |

*without mattress

Description of Symbols

This document contains different typefaces and symbols designed to improve readability and increase understanding of its content.









The symbol below highlights a **WARNING** or **CAUTION**.



WARNING: Identifies situations or actions that may affect patient or user safety. Disregarding a warning could result in patient or user injury.



CAUTION: Points out special procedures or precautions that personnel must follow to avoid equipment damage.

| Symbol | Description |
|---|---|
|  | Type B applied part according to IEC 60601-1 (UL 60601-1). |
| IPX4 | According to IEC 60529, rating for protection against fluid ingress and identified as equipment that is protected against spraying and splashing water. |
| IPX0 | Ordinary equipment not rated for fluid ingress per IEC60529. This applies to exam light control box ONLY. |
|  | CAUTION: Consult accompanying documents. |
| CPR | CPR control - activates the CPR function. |
|  | CAUTION: Pinch Point for hands. Keep hands clear. |
|  | CAUTION: Pinch Point for feet. Keep feet clear. |
|  | CAUTION: Note the orientation of the Headboard when installing onto bed frame. |
|  | Earth Ground Location |
|  | Equipotential Ground Location |
|  | Safe Working Load - Shows the safe working load of the bed. |



WARNING: Do not operate the bed beyond the recommended Patient Characteristics. Failure to observe this warning may result in patient injury or equipment damage.

Warnings



WARNING: To avoid risk of electric shock, this equipment must only be connected to a main power supply with protective earth.



WARNING: To prevent damage to the AC power cord, remember the following:

- Disconnect the plug from the mains outlet prior to moving the bed.
- Provide some slack in the cord between the bed and the main outlet (i.e., the cord should not be pulled taut or under tension).
- Try to keep the power cord off of the floor (use the cord clip provided when possible). This will prevent other equipment from crushing the cable.



WARNING: The multi-pin connector for Nurse Call function is intended only for connection to the hospital's nurse station communication system, or medical equipment complying with IEC 60601-1:1988 + A1:1991 + A2:1995.



WARNING: The AC power cord is considered a main power isolation device. Avoid plugging the AC power cord in a hard-to-reach location (e.g., behind equipment or furniture). In the event of an emergency, the power cord must be readily accessible for disconnection.

To prevent possible equipment damage during bed articulation, position the bed at least 1' (30 cm) away from the headwall.

Prior to operating the bed movement controls, ensure that all persons or equipment are clear of the bed mechanisms. To stop a movement, immediately release the button being pressed.

The bed height should be set to the LOWEST POSITION any time the patient will be left unattended. This is to reduce the risk of injury due to patient falls.

Depending on the condition of the patient, the bed platform should be placed in the FLAT POSITION any time the patient will be left unattended. This is to reduce the risk of patient entrapment.

The "Lock Out" controls should be used by the caregiver to restrict visitors or patients from accessing the associated functions. It is recommended to lock any functions that may cause injury to the patient.

Patient's visitors should be instructed not to use the caregiver controls. The visitor may assist the patient via the patient controls.

Patients should be monitored intermittently to ensure correct patient positioning on the bed and proper usage of siderails.

Note the location of cords or hoses during bed movements. Proper line management is essential to reduce the chance of catching or pinching hazards from occurring.

Only use accessories approved for the Apollo MS-SC bed. See "Accessories List" (Page 35) for list of approved accessories and usage guidelines.

Warnings

The bed should be installed, cleaned and used as described within this manual.

The bed should be operated by facility caregivers and facility-authorized service personnel only.

The maximum load capability of the bed including the patient surface is 550 lbs (250 kg). Exceeding load restrictions could cause excessive wear to the parts and damage the bed, resulting in patient injury or death.

Entering and exiting the bed has to be done at the side with the siderails lowered completely.

Avoid sitting at the extreme ends of the bed (Fowler Section and Foot Section).

It is recommended not to use water or silicone surfaces in order not to exceed the maximum weight limit of 550 lbs (250 kg).

For information on "Cleaning Procedures", please see Page 17.

For information on "Electromagnetic Compatibility", please see Pages 41-44.

Intended Use

The Apollo MS-SC bed is intended for patients in Acute-Care and L.T.A.C. hospitals. This Manual provides instructions required for normal operation of the Apollo MS-SC bed from Amico Beds Corporation. Prior to operation of this bed, it is important that this manual is read and ensure that all safety aspects contained in this manual are strictly adhered to.

Introduction

The Apollo MS-SC has been designed specifically to help caregivers assist patients in the Acute-Care and long-term acute care. This bed features several features such as the integrated foot extender, removable headboard and footboard, and a battery back-up system.

The motions of the Apollo MS-SC are achieved by independent DC electric motors through controls located on the siderails of the bed allowing positions to be changed. The motors are also equipped with overheat protection.

This allow easier maneuverability during patient transport and to help avoid back injury in the caregivers. The battery back-up system also provides peace of mind during transportation or unexpected power outages, allowing the bed positions to be adjusted accordingly.

Features

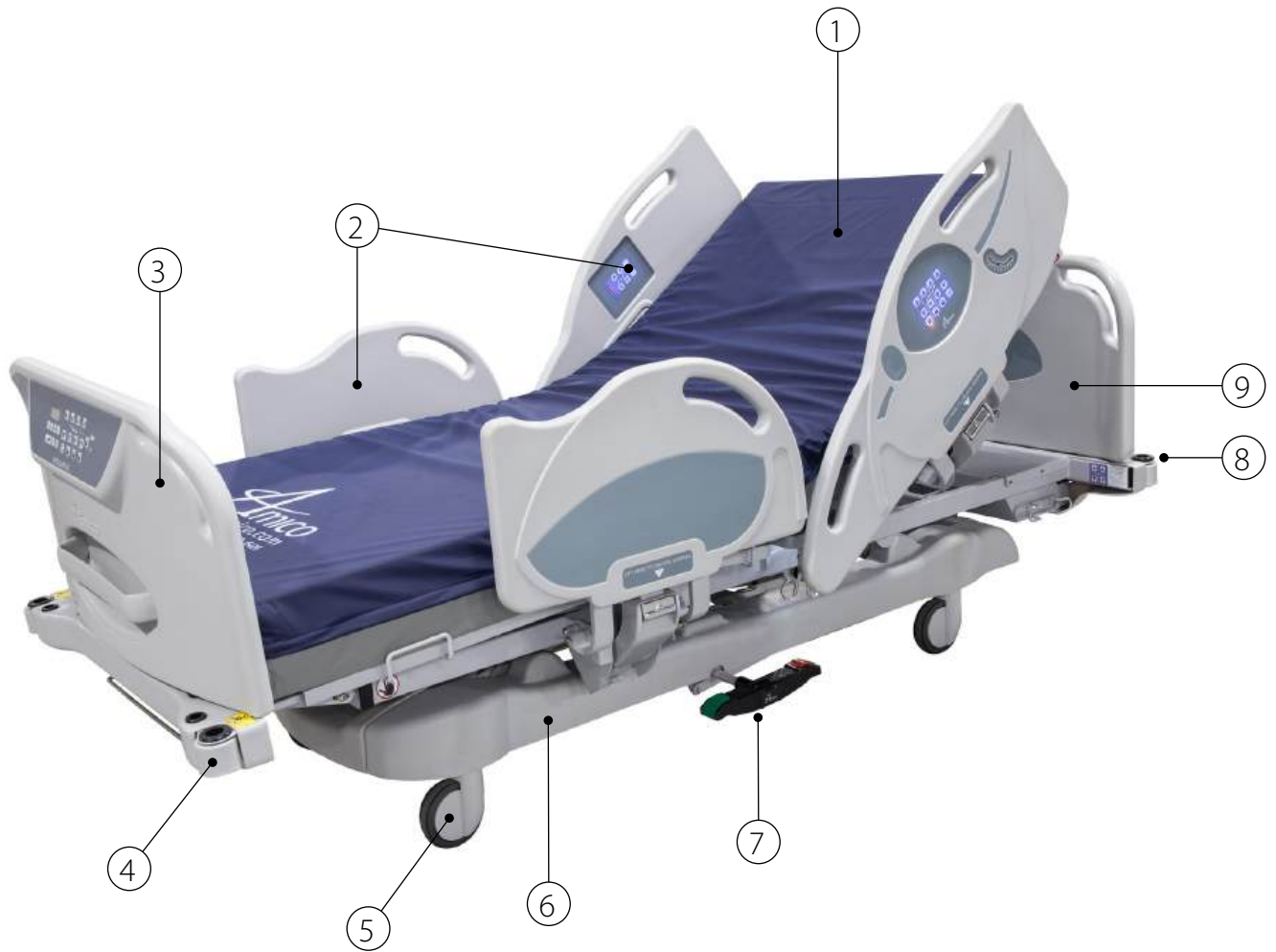

| Item | Description | Item | Description |
|------|-----------------------------|------|-------------------------|
| 1 | Mattress | 6 | Base Cover |
| 2 | Foldable Siderails | 7 | Brake Pedal |
| 3 | Footboard | 8 | IV Pole Mounting Socket |
| 4 | Corner Roller Bumpers | 9 | Headboard |
| 5 | 5" (13 cm) urethane Casters | | |

Siderail & Footboard Controls

The Apollo MS-SC utilizes four 24V DC LINAK actuators to enable the bed to achieve the following motions:

- Head (Fowler) UP
- Head (Fowler) DOWN
- Knee UP
- Knee DOWN
- Bed UP
- Bed DOWN
- Trendelenburg
- Reverse Trendelenburg

Bed motions can be controlled via the exterior siderail controls for caregivers and interior siderail controls for patients*. Optional controls include Footboard controls for caregivers and a hand pendant for patients to adjust a position press and hold down the appropriate button. Only one operation can be made at a time. (i.e., Do not try and adjust knee gatch and bed height at the same time).

Siderail Controls

| Button | Name | Function |
|--------|-----------------------|---|
| A | Bed Height Up | Press on this button to raise height of bed to desired position. |
| B | Bed Height Down | Press on this button to lower height of bed to desired position. |
| C | Knee Gatch Up | Press on this button to raise knee gatch section to the desired angle. |
| D | Knee Gatch Down | Press on this button to lower knee gatch section to the desired angle. |
| E | Fowler Up | Press on this button to raise fowler section of the bed to desired angle. |
| F | Fowler Down | Press on this button to lower fowler section of the bed to desired angle. |
| G | Reverse Trendelenburg | Press on this button to place the bed in the desired reverse Trendelenburg position. |
| H | Trendelenburg | Press on this button to place the bed in the desired Trendelenburg position. |
| I | Bed Flat | Press this button to achieve a flat position from any articulated position. If a flat patient surface and level upper frame is desired, press and hold this button. After 30 seconds, the bed will move to the Low Height, thus attaining a level upper frame. |
| J | Lock Out | Press this button to lock-out the movement functions directly above the button. Press it again to unlock the functions. |
| N | Nurse Call | Press this button to call for nurse assistance. |
| P | Under-Bed Light | Press this button to turn ON/OFF the under Bed Light. |

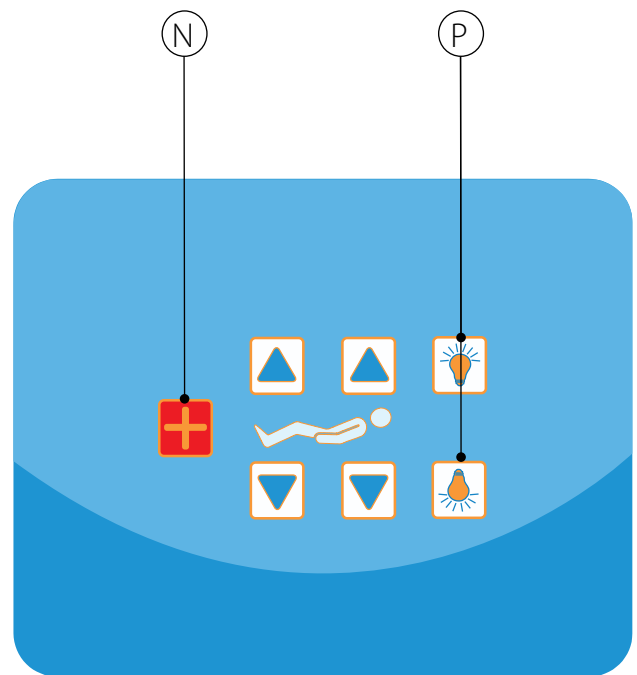
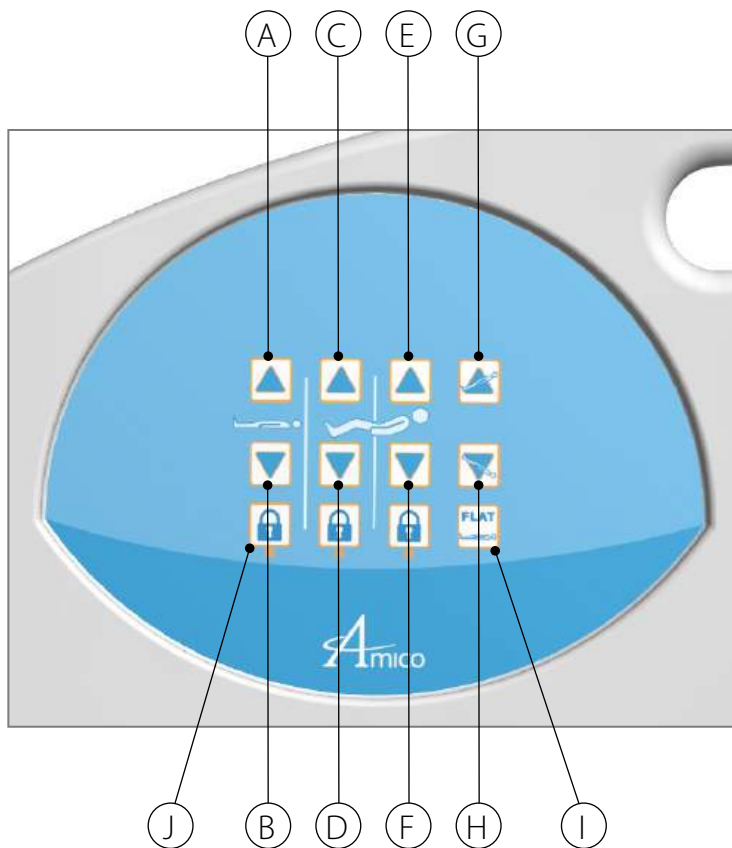

***NOTE:** For the safety of the patient, only the Head UP/DOWN and Knee UP/DOWN motions are available on the interior siderail controls. It is recommended that the Lock-Out feature be used to restrict these motions if articulation may cause the patient further injury.

Footboard Controls

NOTE: Buttons A, B, C, D, E, F, G, H, I and J are same functionality as siderails buttons.

| Button | Name | Function |
|--------|------------------------|---|
| K | Total Lock-Out | Press this button to lock ALL bed movement functions. Press it again to unlock the functions. |
| L | Battery Indicator | Indicator will be GREEN when bed is plugged in and battery is charging. Indicator will be AMBER when the bed is operating on battery power only and requires charging. |
| M | Maintenance Indicator | Indicator will be lit when an error is detected. The bed should be removed from operation and sent for maintenance as soon as possible. |
| Q | Enable Button | Press this button to activate the scale functions. |
| R | Reset/Zero Button | Press this button to “zero” the scale. (i.e. resetting the scale). This must be carried out BEFORE the patient enters the bed. Place the mattress and any accessories onto the bed before resetting the scale. |
| S | Bed Exit Alarm Button | To activate the Bed Exit Alarm, press this button while the patient is in the bed. The alarm is activated when a 50% loss-of-weight on the load cells is detected. The alarm will sound and remain on until the patient is attended to and the button is pressed to silence the alarm. |
| T | Auto-Compensate Button | This feature allows staff to add or remove items from the bed without affecting the patient weight reading. <i>To use the Auto-Compensate feature:</i> <ul style="list-style-type: none"> • Press the button and the LED will begin to blink and will continue blinking until the weight is stable. The display will show “AUTO” during this time. • When the LED stops blinking, items can be added or removed from the bed. (Max. of 120 lbs, without exceeding Safe Working Load). • After the items have been added/removed, press the button again and wait for the LED to stop blinking. • Press the Scale Button to display the patient weight. The LED above the Auto-Compensate will illuminate with the Scale LED to indicate that the reading has been “compensated”. |
| U | Volume Control | Press this button to alternate between the three Volume levels (indicated by the LEDs). |
| V | Scale Button | Press this button to measure the weight of the patient. The display will flash the weight and become solid when the weight is stable. To switch between Pounds (lbs) and Kilograms (kg), press the Scale (V) and Accuracy (X) buttons simultaneously and hold for 5 seconds. The Display will automatically change to the other unit. |
| W | Display | Displays the weight or error codes. |
| X | Accuracy Button | Press this button to display the patient weight to an accuracy of one decimal place. e.g., Default display of the patient weight is 185 lbs. Pressing the Accuracy Button shows 184.8 lbs. |

Footboard Controls

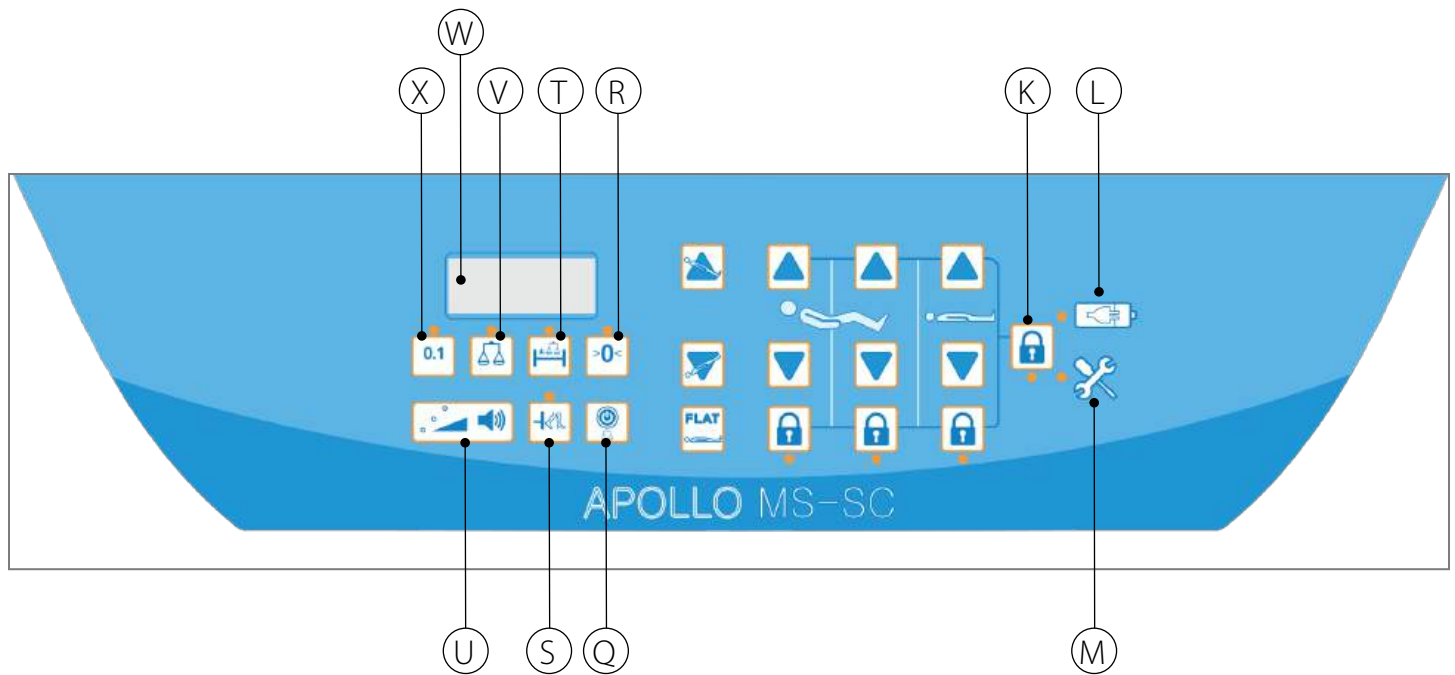

NOTE: The “Total Lock Out” feature (Button K) will disable all bed movement controls except for emergency CPR.

NOTE: “Lock Out” features (Buttons J and K) will also disable bed movement controls on the Patient Hand Pendant.

Central Locking System

Locking the Bed:

- a. To place the bed into a locked position, push down on the Red pedal with your foot. Ensure that the brakes are properly locked in place before moving away from the bed. To ensure that the brakes are engaged, try moving the bed slightly.

Unlocking the Bed:

- a. To unlock the bed, push down on the Green pedal with your foot.



CAUTION: The Locking System should always be set to BRAKE unless the bed is going to be moved.



Using the CPR Release Lever:

- a. To use the CPR Release Lever, pull the lever outward with one hand and slowly push the fowler section down with the other hand.

NOTE: The CPR Release should only be used for emergencies only. It is recommended that the fowler section is completely lowered to a flat position when the CPR release lever is used. Avoid using the CPR Release to attain an angled fowler.



Installation and Removal of the Head/Footboards

To install the Footboard, align the pins on the foot extension section with the corresponding plastic guides. Allow the footboard pins to slide into the plastic guides. The connector for the board controls should also mate with the male connector on the bed. Ensure that the footboard is properly inserted before use.

To install the Headboard, align the pins with the corresponding plastic guides on the head end support of the bed. Insert the headboard by pushing the pins into the guides. Ensure that the headboard is properly inserted before use.

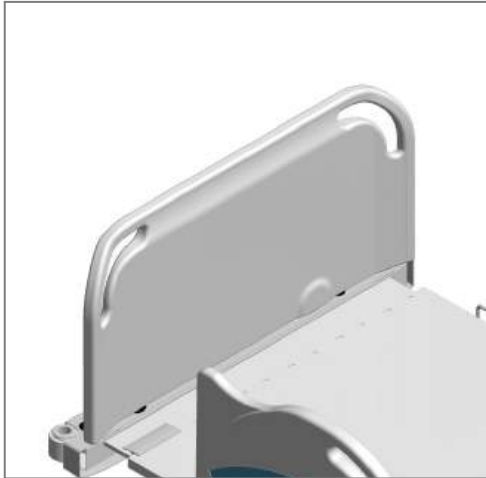

To remove headboard/footboard, lift vertically until the pins come out of the plastic guides.

Siderails

Lowering Siderails:

- a. To lower the siderails, place hand under the plastic latch and pull forward. Once latch is released, the siderail will slowly lower.



Siderails

Raising Siderails:

- a. To raise the siderails, place both hands on the rail and gently pull up. Once the rail reaches the top, it will lock in place. Ensure that the siderail is properly locked in place before using the bed or leaving the patient to avoid patient injury.

NOTE: Patients should be monitored intermittently to ensure correct patient positioning on the bed and proper usage of siderails.



Electrical

This product comes with a battery backup system which includes one sealed, lead-acid 12 V battery located in the control unit box. To ensure that the battery has a full charge, refer to the “Batteries” section on page 27.

The Apollo MS-SC features two exterior siderail controls for caregivers and two interior siderail controls for patients.

The Apollo MS-SC utilizes a multi-pin jack to connect to the hospital’s nurse call system. The jack is located at the head-end of the bed on the patient’s left side. To connect the nurse call feature, plug one end of the multi-pin cord* into the bed-mounted jack and the other end into the wall-mounted jack.

***NOTE:** The multi-pin cord (37-pin Nurse Call Connector) is an optional item from Amico Beds and may not be included with your product. If a multi-pin cord is required, please see the “Cables” section of the manual for a part number and contact Amico Beds CSR to place an order.

Preventive Maintenance



WARNING: Only facility-authorized personnel should service the Apollo MS-SC bed. Servicing performed by unauthorized personnel could result in personal injury or equipment damage.

The Apollo MS-SC bed requires an effective maintenance program. We recommend that you perform annual preventive maintenance (PM) and testing for Joint Commission on Accreditation of Health Care Organizations (JCAHO). PM and testing not only meet JCAHO requirements but will help ensure a long, operation life for the Apollo MS-SC bed.

Preventive maintenance will minimize downtime due to excessive wear.

Perform annual preventive maintenance procedures to make sure all Apollo MS-SC bed components are functioning as originally designed. Pay particular attention to safety features that include, but are not limited to, the following:

- Condition of the Headboard, Footboard, and Siderails
- Siderail latching mechanisms
- Caster braking systems
- Integrity of sleep surface ticking
- Integrity of warning/cautions labels
- Integrity of the various cables (AC power, signal cables, etc.)

Cleaning Procedures

Bleach Cleaning Instructions

If none of the approved cleaning products provide the disinfectant level required then use a solution of 5.25% Sodium Hypochlorite diluted to 1 part bleach to 50 parts water (1000ppm), (volume to volume).

Bleach products are corrosive and degrading in nature and may cause damage to your product. If bleach is used, measures must be taken to ensure the product is rinsed thoroughly with clean water and thoroughly dried. Failure to rinse and dry the product will leave a corrosive residue on the surface possibly causing corrosion.

NOTE: Failure to follow the above directions may void the product's warranty.

- Do not expose the bed to excessive moisture
- Do not immerse the bed or its components in water
- Do not attempt to clean or degrease the steel shafts of the actuators
- Use only approved cleaning products. If bleach is being applied to the product, strictly adhere to the "Bleach Cleaning Instructions".
- For electrical components, please do not unplug the handset or actuators from the control box for cleaning
- Do not use a water temperature of more than 50°C or 122°F

NOTE: For mattresses, please refer to mattress cleaning instructions.

Before Cleaning

- Disconnect or unplug the power cord from the main supply
- Set the bed to BRAKE by pressing on the brake pedals

During Cleaning

- Do not use abrasive cleaning products
- Do not use oil-based products
- Do not use a steam cleaner, washing tunnel, high-pressure spray or hose

To Wash:

- Wipe with a sponge or soft cloth wetted with warm water containing soap or mild detergent

To Dry:

- Thoroughly wipe with a dry sponge or soft cloth

To Disinfect:

- Wash the surface with one of the approved cleaners or refer to the "Bleach Cleaning Instructions" if bleach needs to be used
- Wipe off residue with water using a soft cloth or sponge
- Thoroughly dry

Cable Schematic

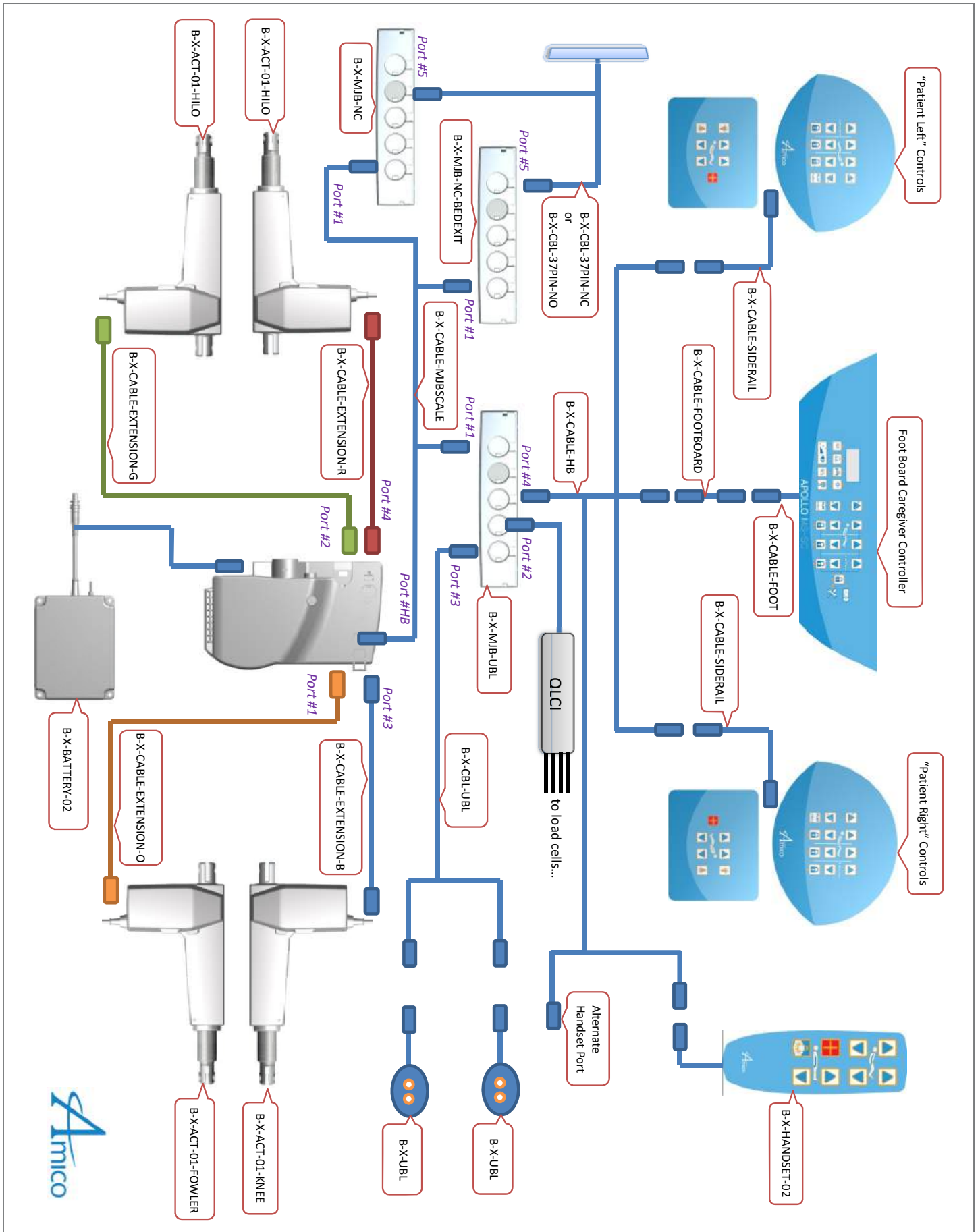









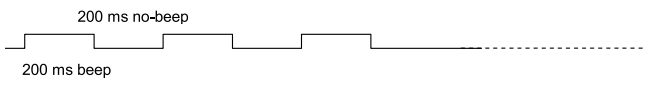

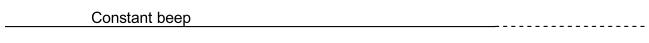

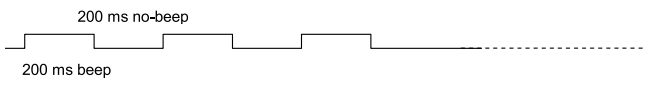
Troubleshooting

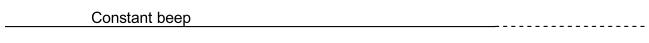
The following tools may be required:

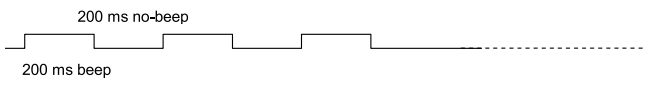
- 3/8" wrench
- 7/16" combination wrench
- 1/2" combination wrench
- 9/16" combination wrench
- Philips-head screwdriver (Sizes #1 and #2)
- Slot-head screwdriver
- Needle-nose pliers
- Rubber mallet
- Cable ties
- Wire cutter
- Multimeter/voltmeter
- If any cables need to be replaced, consult the "Cable Schematic" and note the corresponding part number.
- To remove damaged cables, use the wire cutters to remove any cable ties holding the cable in place. Note the location of the cable tie(s) so that the new cable is secured in the same place(s).

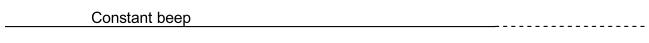
Troubleshooting

| Item No. | Problem Descriptions | Troubleshooting Steps | | | | | | | | | | |
|---|--|---|-----------------------------|----------|--|--|---|---|--|--|---|---|
| 1 | Bed “beeps” when buttons are pressed or the “Maintenance Indicator” LED is ON. | <p>a. Press & hold any Bed Movement button. The Control Box will ‘beep’ with a specific pattern.</p> <p>b. Refer to the chart below to determine the Acoustic Error Signal that matches the ‘beep’ coming from the Control Box.</p> | | | | | | | | | | |
| <p>Acoustic Error Reference Chart</p> <table border="1"> <thead> <tr> <th data-bbox="193 541 857 583">Error Name & ‘Beep’ Pattern</th> <th data-bbox="857 541 1523 583">Solution</th> </tr> </thead> <tbody> <tr> <td data-bbox="193 583 857 863"> <p>Position Lost in HI-LO Actuators</p>  <p>200 ms no-beep 200 ms beep</p> </td> <td data-bbox="857 583 1523 863"> <ul style="list-style-type: none"> • Make sure the bed is plugged into Mains Power. • Press & Hold the “Bed Height DOWN” button to lower the bed (it is normal for the Control Box to continue to ‘beep’ while this happens). • When the bed is completely lowered to its Low Height, Press & Hold the “Bed Height UP” to raise the bed and confirm that the ‘beeping’ has stopped. </td> </tr> <tr> <td data-bbox="193 863 857 1142"> <p>Fatal Error</p>  <p>500 ms no-beep 50 ms beep</p> </td> <td data-bbox="857 863 1523 1142"> <ul style="list-style-type: none"> • On any Bed Control Interface, Press & Hold the “Fowler DOWN” and “Knee DOWN” buttons SIMULTANEOUSLY. • The Control Unit will “beep” several times (if there is no “beeping”, repeat Step 1). Continue to hold the buttons until the “beeping” stops. • Release the buttons. </td> </tr> <tr> <td data-bbox="193 1142 857 1388"> <p>Battery Voltage Low</p>  <p>Constant beep</p> </td> <td data-bbox="857 1142 1523 1388"> <ul style="list-style-type: none"> • Plug the bed into Mains Power at the earliest opportunity. • Leave the bed plugged into Mains Power for at least 4 hours to charge the battery to 80% capacity. • Refer to the “Batteries” section of the manual for additional information. </td> </tr> <tr> <td data-bbox="193 1388 857 1581"> <p>Overheating</p>  <p>5 s beep no-beep</p> </td> <td data-bbox="857 1388 1523 1581"> <ul style="list-style-type: none"> • Refrain from using the bed functions for at least 20 minutes. This will allow the Control Box and the Actuators to cool down. • After 20 minutes, confirm that the overheating error has stopped by resuming normal bed functions. </td> </tr> </tbody> </table> | | | Error Name & ‘Beep’ Pattern | Solution | <p>Position Lost in HI-LO Actuators</p>  <p>200 ms no-beep 200 ms beep</p> | <ul style="list-style-type: none"> • Make sure the bed is plugged into Mains Power. • Press & Hold the “Bed Height DOWN” button to lower the bed (it is normal for the Control Box to continue to ‘beep’ while this happens). • When the bed is completely lowered to its Low Height, Press & Hold the “Bed Height UP” to raise the bed and confirm that the ‘beeping’ has stopped. | <p>Fatal Error</p>  <p>500 ms no-beep 50 ms beep</p> | <ul style="list-style-type: none"> • On any Bed Control Interface, Press & Hold the “Fowler DOWN” and “Knee DOWN” buttons SIMULTANEOUSLY. • The Control Unit will “beep” several times (if there is no “beeping”, repeat Step 1). Continue to hold the buttons until the “beeping” stops. • Release the buttons. | <p>Battery Voltage Low</p>  <p>Constant beep</p> | <ul style="list-style-type: none"> • Plug the bed into Mains Power at the earliest opportunity. • Leave the bed plugged into Mains Power for at least 4 hours to charge the battery to 80% capacity. • Refer to the “Batteries” section of the manual for additional information. | <p>Overheating</p>  <p>5 s beep no-beep</p> | <ul style="list-style-type: none"> • Refrain from using the bed functions for at least 20 minutes. This will allow the Control Box and the Actuators to cool down. • After 20 minutes, confirm that the overheating error has stopped by resuming normal bed functions. |
| Error Name & ‘Beep’ Pattern | Solution | | | | | | | | | | | |
| <p>Position Lost in HI-LO Actuators</p>  <p>200 ms no-beep 200 ms beep</p> | <ul style="list-style-type: none"> • Make sure the bed is plugged into Mains Power. • Press & Hold the “Bed Height DOWN” button to lower the bed (it is normal for the Control Box to continue to ‘beep’ while this happens). • When the bed is completely lowered to its Low Height, Press & Hold the “Bed Height UP” to raise the bed and confirm that the ‘beeping’ has stopped. | | | | | | | | | | | |
| <p>Fatal Error</p>  <p>500 ms no-beep 50 ms beep</p> | <ul style="list-style-type: none"> • On any Bed Control Interface, Press & Hold the “Fowler DOWN” and “Knee DOWN” buttons SIMULTANEOUSLY. • The Control Unit will “beep” several times (if there is no “beeping”, repeat Step 1). Continue to hold the buttons until the “beeping” stops. • Release the buttons. | | | | | | | | | | | |
| <p>Battery Voltage Low</p>  <p>Constant beep</p> | <ul style="list-style-type: none"> • Plug the bed into Mains Power at the earliest opportunity. • Leave the bed plugged into Mains Power for at least 4 hours to charge the battery to 80% capacity. • Refer to the “Batteries” section of the manual for additional information. | | | | | | | | | | | |
| <p>Overheating</p>  <p>5 s beep no-beep</p> | <ul style="list-style-type: none"> • Refrain from using the bed functions for at least 20 minutes. This will allow the Control Box and the Actuators to cool down. • After 20 minutes, confirm that the overheating error has stopped by resuming normal bed functions. | | | | | | | | | | | |

Troubleshooting

| Item No. | Problem Descriptions | Troubleshooting Steps |
|----------|--|--|
| 2 | <p>No motion when controls are pressed.</p>  | <ol style="list-style-type: none"> Connect bed to wall outlet and try again. If motion can be achieved, this means that the battery level may be low. Leave bed connected to wall until full charge is completed. (See "Battery Charging Characteristics" on Page 29). If functions are lost again when the bed is disconnected from the wall outlet, the battery may be faulty. To check this, raise the Fowler to the upright position to access the Control Box. Disconnect the bed from the wall outlet. Remove the Control Box Cover (3 screws). The battery is held to the pan via Phillips-head machine screws. Using a slot-head screwdriver, remove the locking clip that secures the battery jack in the Control Unit. Pull out the battery jack and remove the battery from the pan. Using a voltmeter set at 200V, test the battery voltage by placing the leads on the jack. If no reading is displayed, a replacement battery is required. If step "a" does not correct issue, proceed to check all electrical terminals. If any loose connection is detected, firmly insert the plug into the electrical terminals. Also verify electrical connections between the control box and the siderails or footboard. To check the electrical connection between the Control Unit and Siderail Controls, locate the signal cable as shown in Step 2 of "Head Siderail Replacement". If any cables are damaged, please contact Amico Beds CSR to request a replacement. (See "Replacement Parts List" for part number). |
| 3 | <p>CPR mechanism does not work: fowler does not lower when the CPR handle is pulled and weight is applied.</p> | <ol style="list-style-type: none"> Using the electronic controls, raise fowler section completely to the upright position. Check the entire length of the CPR cable and note any areas that are pinched. If the cable is damaged in these areas, have the cable replaced immediately. Check the in-line and end-line cable adjustors for signs of loosening or damage. If the adjustors are loose, tighten them down. If the adjustors have been damaged, have them replaced immediately. If problem persists, please contact your Amico Sales Executive for support. |
| 4 | <p>Patient hand pendant is not working.</p> | <ol style="list-style-type: none"> Press a button and check to see if the LED backlighting comes ON. If so, check to see if any Lock Out functions have been engaged. If there is no backlighting, unplug the pendant and plug it into the port on the opposite side of the bed frame. If the pendant works, please contact the Amico Beds CSR for support. If the pendant still does not work, please contact Amico Beds CSR to request a replacement. (See "Replacement Parts List" for part number). |





Troubleshooting

| Item No. | Problem Descriptions | Troubleshooting Steps |
|----------|--------------------------------|--|
| 5 | Brakes do not engage. | <ul style="list-style-type: none"> a. Remove base covers to access the brake mechanism. b. Check all bolted connections between the casters, linkages, and brake pedal. If there are any loose connections (e.g. bolts are wiggling, missing nuts) or disconnected linkages, retighten so that the bolts can only rotate freely. c. Verify that each caster is in Total Lock (no rotation, no swivel). If any casters are not locked, remove the caster and replace it with a new one. (See "Replacement Parts List" for part number). d. If the brakes still do not work, please contact Amico Beds CSR or your Amico Sales Executive for support. |
| 6 | Unintended motion is observed. | <ul style="list-style-type: none"> a. Check all siderail and footboard controls to determine if any of the buttons are being pressed unintentionally. b. If no buttons are visibly being pressed, remove the Footboard and verify if the motion still occurs. If motion ceases, the Footboard control is faulty and may need to be replaced (See "Replacement Parts List" for part number). c. If motion is still observed after Step "b", one of the Siderail Controls may be faulty. Allow the motion to complete (i.e. actuator has reached the end of the stroke), then proceed to Step 2 of the "Head Siderail Replacement" section of this manual. d. Remove one siderail first and check if functionality has been restored. If bed movement control has been restored, the removed siderail is faulty; otherwise, the other siderail is faulty. Replace the faulty siderail by following the "Head Siderail Replacement" section. (See "Replacement Parts List" for part number). e. If the steps above are followed and the problem persists, please contact Amico Beds CSR or your Amico Sales Executive for support. |

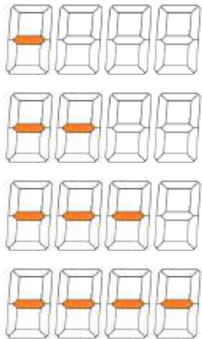
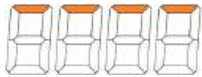

Troubleshooting

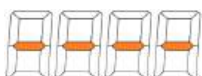
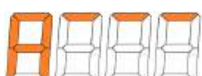
Scale Display Error Codes

The Scale System performs a self-diagnostic check at power-up. During this time, any errors with the Scale System are detected and shown on the LCD display. The chart below illustrates the various icons and error codes that can appear on the LCD display:

| Display | Interpretation | Solution |
|---|--|---|
|  | <p><i>Self-Diagnostic Check at Power-up</i> (One-second pause b/w indications)</p> | <ul style="list-style-type: none"> This is normal operation of the Scale System when the bed is plugged into Mains Power or the Footboard is reconnected to the Frame. |
|  | <p><i>Zeroing Out-of-Range</i> This occurs when there is weight on the bed in excess of 110 lbs (50 kg) when the "ZERO" button is pressed.</p> | <ul style="list-style-type: none"> Remove any weight on the bed (except the mattress) before pressing the "ZERO". Note: the weight of the mattress or air mattress with accompanying pump should not exceed 110 lbs (50 kg). |
|  | <p><i>Below Calibrated Zero</i> This occurs when the weight detected by the system goes below zero.</p> | <ul style="list-style-type: none"> There may be an obstruction to the bed's Upper Frame when the bed was lowered. This "bends" the load cells in the wrong direction, thus producing a negative weight. Check under the Upper Frame of the bed for any obstructions, or move the bed away from the obstruction. |
|  | <p><i>Safe Working Load Exceeded</i> This occurs when the total weight on the bed exceeds 550 lbs (250 kg).</p> | <ul style="list-style-type: none"> The bed should not be operated if the weight on the bed exceeds the Safe Working Load. Remove any unnecessary objects from the bed (such as extra bedding, accessories, or personal belongings) before repeating the "Weigh" function. |
|  | <p><i>Auto-Compensation Out-of-Range</i> This occurs when too much weight is added.</p> | <ul style="list-style-type: none"> The Auto-Compensate function has an allowable weight range of 0-220 lbs (0-100 kg). Do not exceed the limit. |
|  | <p><i>Auto-Compensation Out-of-Range</i> This occurs when too much weight is removed.</p> | <ul style="list-style-type: none"> The Auto-Compensate function has an allowable weight range of 0-220 lbs (0-100 kg). Do not go below the limit. |
|  | <p><i>Load Cell Interface is Disconnected</i> This occurs if the Footboard PCB cannot detect the Load Cell Interface.</p> | <ul style="list-style-type: none"> Check the connections between the Load Cell Interface and the MJB located under the Seat Section. If the connector is plugged in firmly and the error remains, the Load Cell Interface may have been damaged or failed. Contact Amico Beds Customer Service for support. |

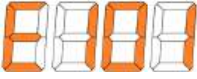
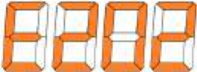
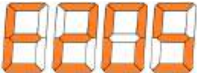
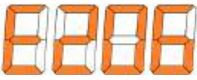
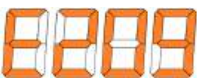
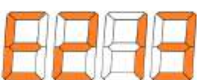
Troubleshooting

| Display | Interpretation | Solution |
|---|--|---|
|  | <i>Load Cell Interface Not Calibrated</i> This occurs when the Load Cell Interface has not been calibrated. | <ul style="list-style-type: none"> Contact Amico Beds Customer Service for support. |
|  | <i>Load Cell Interface Incorrectly Calibrated</i> This occurs when the Load Cell Interface requires re-calibration. | <ul style="list-style-type: none"> Contact Amico Beds Customer Service for support. |
|  | <i>Load Cell #1 is Disconnected</i> This occurs if Load Cell #1 is disconnected or has failed. | <ul style="list-style-type: none"> Unplug the bed from Mains Power, wait 10 seconds, then plug the bed back in and check if the error is cleared. If the error code reappears, contact Amico Beds Customer Service for support. |
|  | <i>Reference Signal for Load Cell #1 is Missing</i> This occurs if the other load cells cannot find the reference signal from Load Cell #1. | <ul style="list-style-type: none"> Unplug the bed from Mains Power, wait 10 seconds, then plug the bed back in and check if the error is cleared. If the error code reappears, contact Amico Beds Customer Service for support. |
|  | <i>Load Cell #2 is Disconnected</i> This occurs if Load Cell #2 is disconnected or has failed. | <ul style="list-style-type: none"> Unplug the bed from Mains Power, wait 10 seconds, then plug the bed back in and check if the error is cleared. If the error code reappears, contact Amico Beds Customer Service for support. |
|  | <i>Load Cell #3 is Disconnected</i> This occurs if Load Cell #3 is disconnected or has failed. | <ul style="list-style-type: none"> Unplug the bed from Mains Power, wait 10 seconds, then plug the bed back in and check if the error is cleared. If the error code reappears, contact Amico Beds Customer Service for support. |
|  | <i>Load Cell #4 is Disconnected</i> This occurs if Load Cell #4 is disconnected or has failed. | <ul style="list-style-type: none"> Unplug the bed from Mains Power, wait 10 seconds, then plug the bed back in and check if the error is cleared. If the error code reappears, contact Amico Beds Customer Service for support. |

NOTE: All icons and error codes will disappear after 20 seconds, but it does not mean the error is resolved. To make the code reappear on the display, press any button on the Scale System Controls.

Head Siderail Replacement

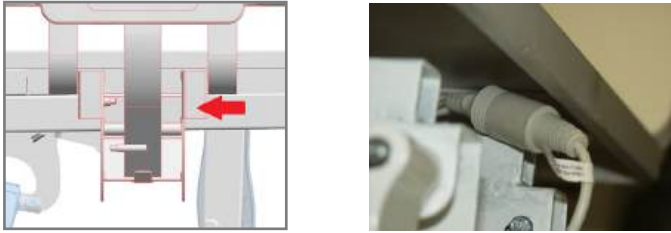
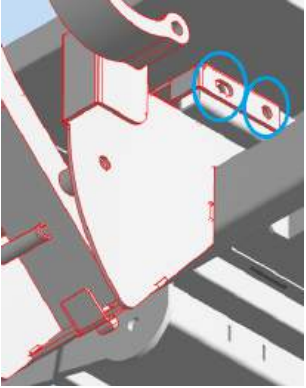

WARNING: Replacement of Siderail MUST be completed per the instructions below and only using Amico approved parts. Failure to comply may result in significantly-reduced effectiveness of the safety features of the system.

| Step No. | Procedure | Illustrations |
|----------|---|--|
| 1 | Locate Head Siderail that requires replacement. Make sure that replacement Head Siderail corresponds to the correct side of the bed. |  |
| 2 | Disconnect the signal cable from the main harness. To disconnect the cable, remove the locking nut first. |  |
| 3 | Locate the bolts holding the Head Siderail to the Fowler frame. Using a 1/2" (13 mm) wrench/socket, remove the bolts and pull the Head Siderail away from the Fowler. |  |
| 4 | To install the new Head Siderail, perform the above steps in reverse. With the new Head Siderail plugged in, check that the buttons are working properly. | |

Foot Siderail Replacement

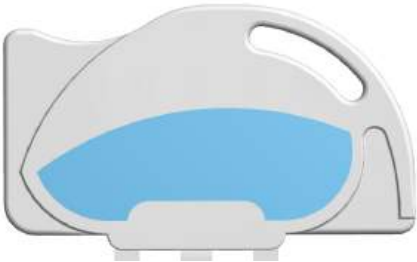
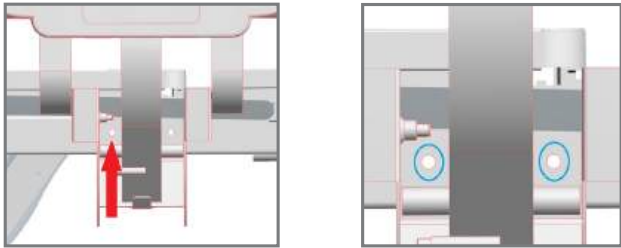
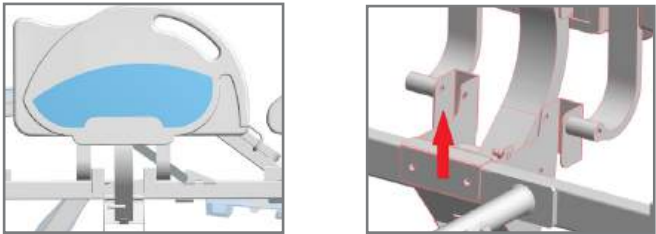

WARNING: Replacement of Siderail MUST be completed per the instructions below and only using Amico approved parts. Failure to comply may result in significantly-reduced effectiveness of the safety features of the system.

| Step No. | Procedure | Illustrations |
|----------|---|--|
| 1 | Locate Foot Siderail that requires replacement. Make sure that replacement Foot Siderail corresponds to the correct side of the bed. |  |
| 2 | Locate the bolts holding the Foot Siderail to the Upper frame. Using a 1/2" (13 mm) wrench/socket, remove the bolts. |  |
| 3 | Raise the Knee Section and remove the Foot Siderail by unhooking it from the Upper Frame. |  |
| 4 | To install the new Foot Siderail, perform the above steps in reverse. With the new Foot Siderail plugged in, check that the buttons are working properly. | |

Batteries



WARNING: The Battery is secured within an enclosure in the bed and can only be removed using tools. It is not necessary to remove the battery if the bed is not used for an extended period of time. If the Battery requires servicing or replacement, only facility-authorized service personnel should be allowed to remove it from the enclosure.

How to handle LINAK's rechargeable lead acid batteries to obtain the longest possible life. The below standing figure represents the relation between discharging depth and expected battery life, given in number of cycles.

Figure 1
Charging / Discharging Cycles

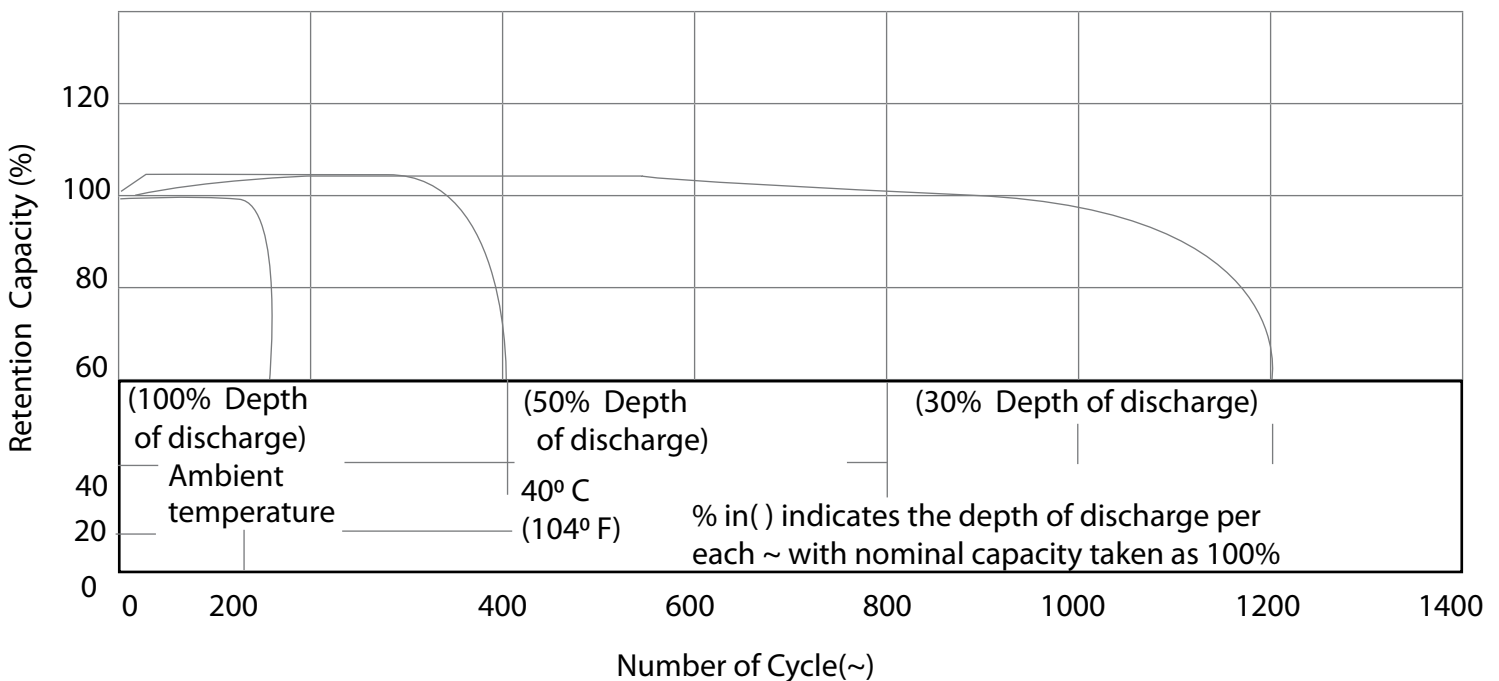

The curves can be explained as follows:

- 100% discharging depth - It appears from the curve that there are 180 cycles available at 100% discharging between charging.
- 50% discharging depth - It appears from the curve that there are 400 cycles available at 50% discharging between charging.
- 30% discharging depth - It appears from the curve that there are 1200 cycles available at 30% discharging between charging.



WARNING: To attain the longest battery life, it is recommended to recharge the battery frequently and prevent it from discharging as much as possible.



WARNING: Remember always to have the control box plugged to the main power, thereby keeping the batteries fully charged all the time.

Control Boxes with Battery Back Up Only

Figure 2
Battery Capacity

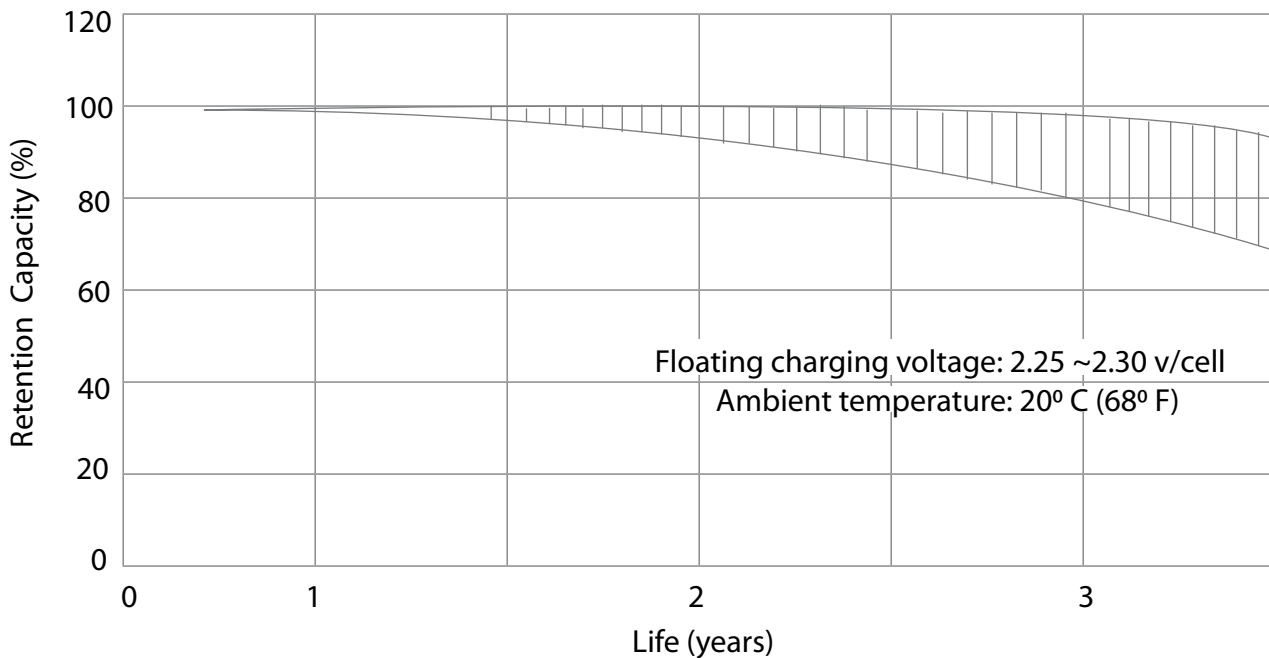

The above figure represents the battery capacity over time at 20°C at constant recharging and no consumption on the battery.

Please be aware that the battery's ability to retain 100% charge capacity will diminish over time, even if it is not being used. This will be evident after three or more years, where the battery will only be able to retain between 80 and 100% of its full capacity.

If the battery is used at a higher temperature than 20°C, the curve, representing the capacity of the battery over the time, is expected to fall even more.



WARNING: Because of the self-discharge, you cannot expect the batteries to be fully charged when they leave the factory. LINAK recommends that the customer charges the batteries immediately upon receipt or, at the latest, 5 months after LINAK's production date. The earlier the batteries are charged, the greater the chance of a longer battery life. The mentioned charging should last min. 24 - 48 hours and longer if possible.

Charging current:

Typical rule: Maximum charging current = 0.25 x battery capacity (Ah)

BAJ1/2 JUMBO: 0.25 x 2.9 = 0.7A

BA1800: 0.25 x 1.2 = 0.3A

Charging voltage:

24V system: Maximum 27.60V

Control Boxes with Battery Back Up Only

The charging current/time by use of the battery back-up.

Example BA1800: Maximum charging current = $0.25 \times$ battery capacity (Ah)

BA1800: $0.25 \times 1.2 =$ Approx. 0.3 A.

Charging time: Approximately 1.2 Ah : 0.3 A = Approx. 4-5 hours.

Example BAJ1/2: Maximum charging current = 0.25×2.9 Ah = Approx. 0.7 A

Charging time: Approximately 2.9 Ah : 0.7 A = 4 – 5 hours

Please observe the curve below or see further information regarding battery characteristics in **Figure 1 and 2**.

Charging characteristics:

- In theory, if the battery capacity is approximately 0% it takes about 4-5 hours to reach 80% of the battery capacity level.
- We recommend a charging time up to approximately 10 hours which gives 100% capacity.
- At 100% capacity the battery will not discharge as quickly as it would at 80% capacity.
- The internal and external battery charging characteristics are identical.
- The battery alarm on a LINAK CB will activate at approx. 18 V. The charging of the battery must be started before reaching this level to maintain as long a battery life as possible.
- We therefore recommend you always to have the control box plugged to the main power, to keep the batteries fully charged.

80% capacity ~ up to 4-5 hours charging time depending on the level of discharging

100% capacity ~ up to 10 hours charging time depending on the level of discharging

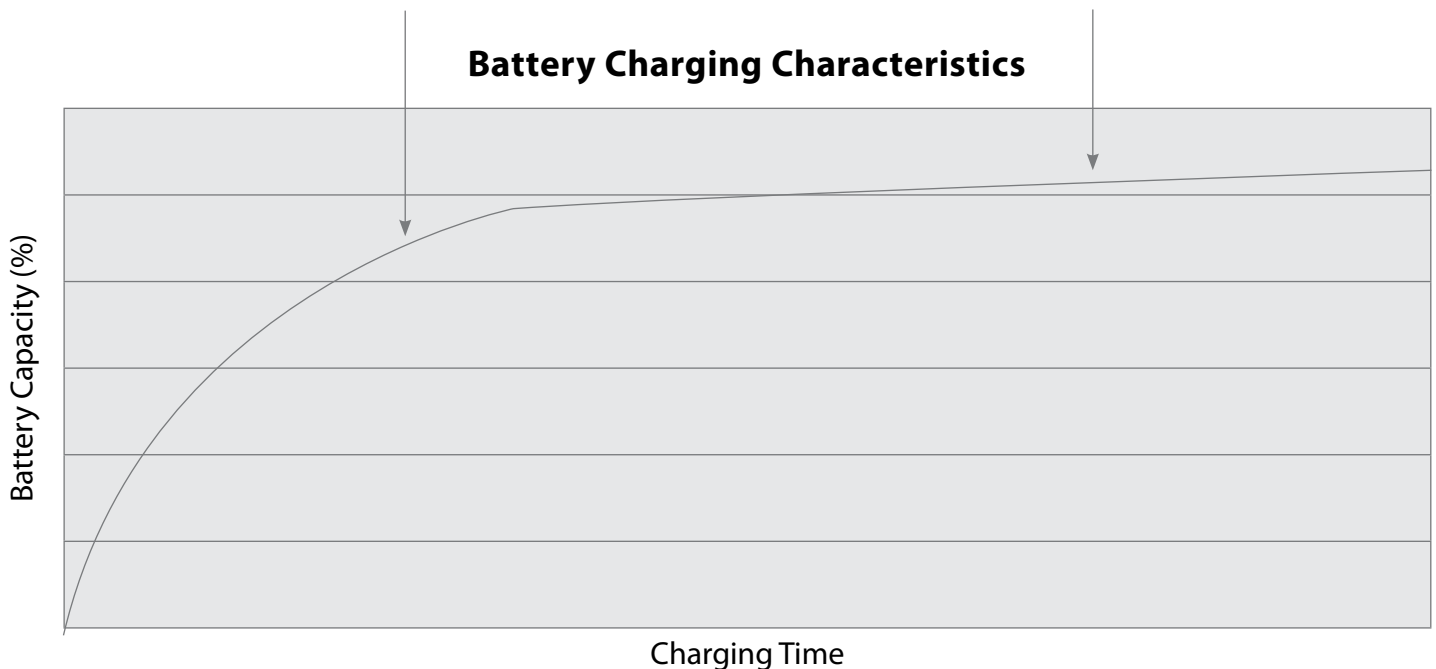

Control Boxes with Battery Back Up Only

We recommend you to discharge the batteries as little as possible to optimize the battery life. The discharging time and the level of the battery capacity depends on the load characteristics of the application and the way in which the battery is used.



WARNING: It is not prohibited to use batteries that are not from LINAK's product range as this will result in overloading LINAK's battery charger.

If replacement batteries are required, please contact Amico Beds CSR for support. (See "Replacement Parts List" for part number)

Specifications are subject to change without prior notice
LINAK SALES BACK-UP
1st edition rev. 2001-03-01

Components List

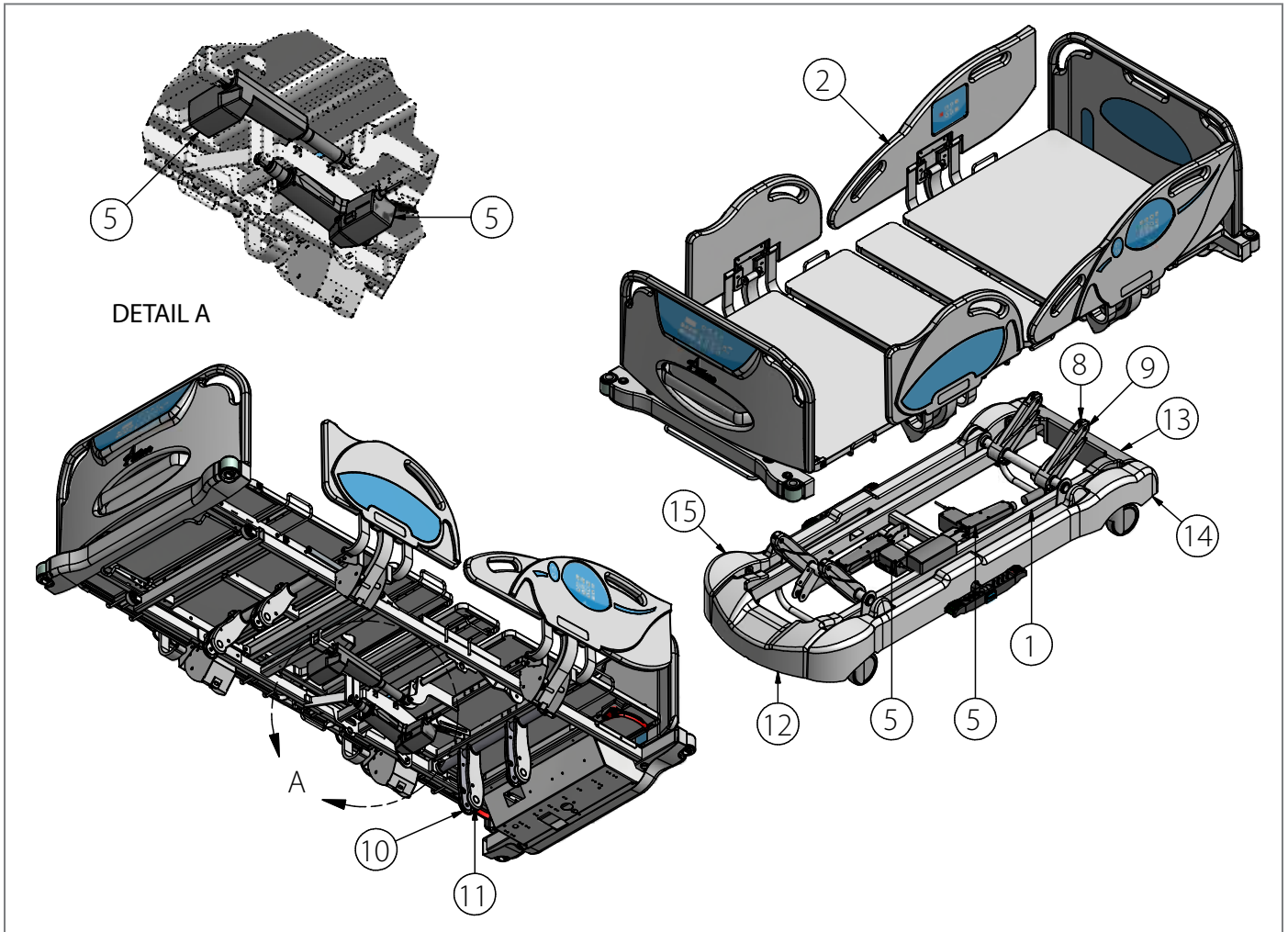

| Item No. | Quantity | Part Number | Description |
|----------|----------|--------------------|--------------------------------|
| 1 | 1 | B-400-LOWER-ASSY2 | Lower Assembly |
| 2 | 1 | B-400-UPPER-ASSY2 | Upper Assembly |
| 3 | 2 | B-X-HILO-LARMS2 | Lower Hi-Lo Arms |
| 4 | 1 | B-X-HILO-UARMS2 | Upper Hi-Lo Arms |
| 5 | 2 | B-X-ACT-01-HILO | LINAK Hi-Lo Actuator |
| 6 | 1 | B-X-ACT-01-FOWLER | LINAK Fowler Actuator |
| 7 | 1 | B-X-ACT-01-KNEE | LINAK Knee Actuator |
| 8 | 4 | B-PCOVER-LARMS-001 | Lower Hi-Lo Arm Cover (Top) |
| 9 | 4 | B-PCOVER-LARMS-002 | Lower Hi-Lo Arm Cover (Bottom) |
| 10 | 4 | B-PCOVER-UARMS-001 | Upper Hi-Lo Arm Cover (Left) |
| 11 | 4 | B-PCOVER-UARMS-002 | Upper Hi-Lo Arm Cover (Right) |
| 12 | 1 | B-X-BASECVR-FOOT2 | Base Cover - Foot |
| 13 | 1 | B-X-BASECVR-HEAD2 | Base Cover - Head |
| 14 | 1 | B-X-BASECVR-LEFT2 | Base Cover - Left |
| 15 | 1 | B-X-BASECVR-RIGHT2 | Base Cover - Right |
| 16 | 2 | S-BRAKE-PEDAL | Brake Pedal |

Components List

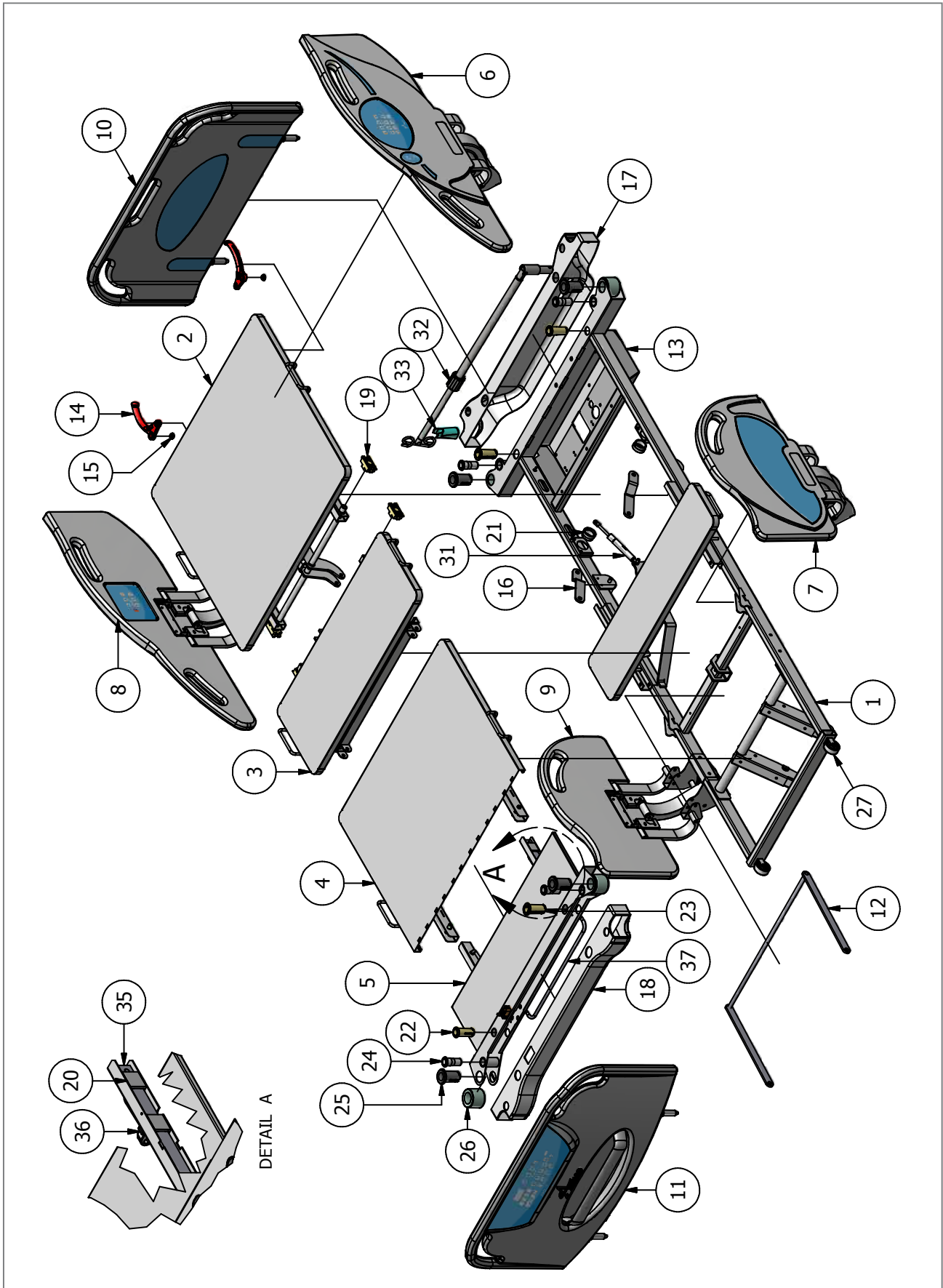

Components List

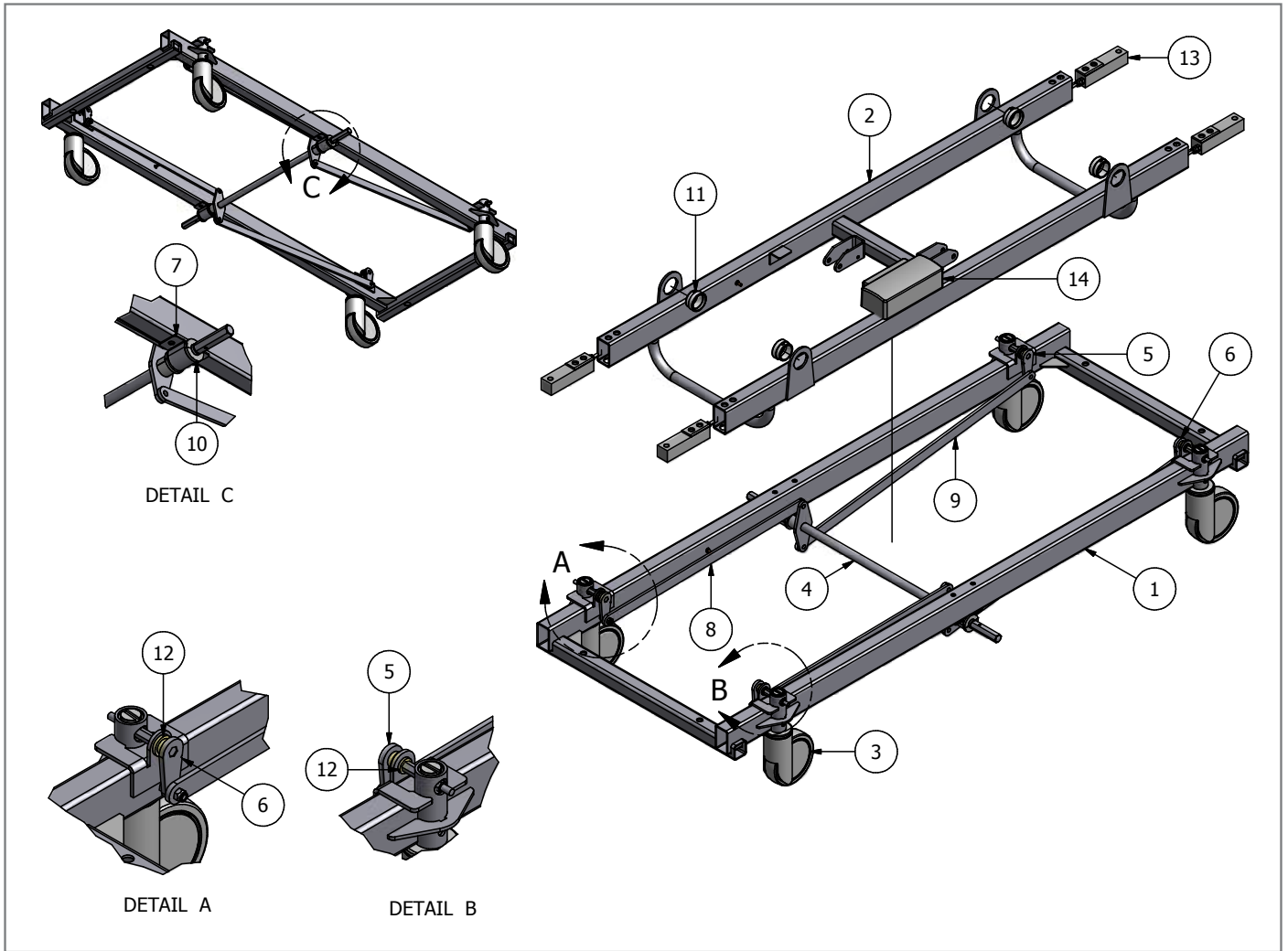

| Item No. | Quantity | Part Number | Description |
|----------|----------|---------------------|--|
| 1 | 1 | B-X-FRAME-UPPER2 | Upper Frame |
| 2 | 1 | B-X-FOWLER2 | Fowler |
| 3 | 1 | B-X-KNEE2 | Knee Section |
| 4 | 1 | B-X-FOOT | Foot Section |
| 5 | 1 | B-X-FOOTEXT | Foot Extension |
| 6 | 1 | B-4000-SRAIL-LHEAD | Siderail - Head Left |
| 7 | 1 | B-4000-SRAIL-LFOOT | Siderail - Foot Left |
| 8 | 1 | B-4000-SRAIL-RHEAD | Siderail - Head Right |
| 9 | 1 | B-4000-SRAIL-RFOOT | Siderail - Foot Right |
| 10 | 1 | B-HEADBOARD | Headboard |
| 11 | 1 | B-FOOTBOARD | Footboard |
| 12 | 1 | B-X-FOOTFORK | Foot Fork |
| 13 | 1 | B-X-CTRBOXPAN | Control Box Pan |
| 14 | 2 | B-X-CPRHAND | CPR Release Handle |
| 15 | 2 | B-X-CPRNUT | CPR Release Nut |
| 16 | 2 | B-X-FOWLER-LINK | Fowler Link Bar |
| 17 | 1 | B-X-ENDCVR-HEAD | Head End Cover |
| 18 | 1 | B-X-ENDCVR-FOOT | Foot End Cover |
| 19 | 4 | B-X-PGUIDE-FOWLER | Fowler Plastic Guide |
| 20 | 2 | B-X-PGUIDE-SLIDE | Slider Plastic Guide |
| 21 | 2 | B-X-PBUSHING-HILO | Hi-Lo Bushing |
| 22 | 2 | B-X-PBUSHING-FB | Footboard Plastic Insert |
| 23 | 2 | B-X-PBUSHING-FB-SL | Footboard Plastic Insert - slotted |
| 24 | 4 | S-X-PBUSHING-IVPOLE | IV Pole Plastic Insert |
| 25 | 4 | B-X-PBUSHING-ETS | Roller Bumper Plastic Bushing |
| 26 | 4 | B-X-BUMPER-ROLLER | Roller Bumper |
| 27 | 2 | B-X-FOOT-ROLLER | Foot Section Roller |
| 28 | 1 | B-X-SEAMCOVER | Seam Cover (NOT SHOWN) |
| 29 | 1 | Cover Plate D-Sub | 37-Pin Connector Cover Plate (NOT SHOWN) |
| 30 | 1 | B-X-GASSPRING-300 | Fowler Gas Spring |
| 31 | 1 | B-FOLDIV | Foldable I.V. Pole |
| 32 | 1 | S-X-IVPOLE-SUPPORT | Foldable I.V. Pole Support |
| 33 | 2 | B-X-FOOT-013 | Slide Plate Spacer (NOT SHOWN) |
| 34 | 2 | B-X-FOOT-SLIDER | Slide Plate |
| 35 | 2 | B-X-PGUIDE-FOOTEXT | Foot Extension Lock Plastic Guide |
| 36 | 1 | B-X-FOOTEXT-LOCK | Food Extension Lock |

Components List

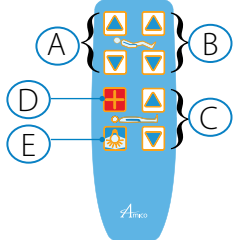

| Item No. | Quantity | Part Number | Description |
|----------|----------|-----------------------|-----------------------------|
| 1 | 1 | B-X-FRAME-LOWER2 | Lower Frame |
| 2 | 1 | B-X-FRAME-LOWER-FLOAT | Lower Floating Frame |
| 3 | 4 | B-CAS-UNI-05B1 | TENTE 5" Bed Caster |
| 4 | 1 | B-X-BRAKE-SHAFT2 | Brake Shaft |
| 5 | 2 | B-X-BRAKE-CASTARM | Brake Caster Arm |
| 6 | 2 | B-X-BRAKE-CASTARM-MIR | Brake Caster Arm (Mirrored) |
| 7 | 2 | B-X-BRAKE-BUSHCRDL | Brake Shaft Bushing Cradle |
| 8 | 2 | B-X-BRAKE-LINK-SH | Brake Linkage - Short |
| 9 | 2 | B-X-BRAKE-LINK-LG | Brake Linkage - Long |
| 10 | 4 | B-X-PBUSHING-BRAKE | Brake Shaft Bushing |
| 11 | 4 | B-X-PBUSHING-HILO | Hi-Lo Bushing |
| 12 | 4 | B-X-PBUSHING-CASTARM | Caster Arm Bushing |
| 13 | 4 | B-X-LOADCELL-250 | Load Cell |
| 14 | 1 | B-X-LOADCELL-BOX | LINAK QLCl Interface |

Accessories List

| Accessories Image | Description and Part Number | How to Use |
|---|--|--|
|  | Foldable I.V. Pole B-FOLDIV | <p>To Use</p> <ul style="list-style-type: none"> • Lift the I.V. pole from the folded position behind the headboard. • Allow the pole to drop into its base support. This will lock the pole in the upright position. • Raise the pole by grasping the telescopic section with one hand and loosening the coupler with the other hand. • Once the desired height is reached, tighten the coupler and the pole is ready to use. <p>To Store:</p> <ul style="list-style-type: none"> • Grasp the telescopic section with one hand and loosen the coupler with the other hand. • Lower the telescopic section until fully collapsed, then tighten the coupler. • Pull the pole upwards to lift it out of the base support. • Rotate the pole down to the folded position behind the headboard. • The pole should come to a rest in the I.V. pole support mounted on the frame. <p>⚠ CAUTION: Do not exceed the 30 lb. max. weight capacity.</p> |
|  | Patient hand pendant B-X-HANDESET-02 | <p>A - Head Section(Fowler)UP/DOWN B - Knee Section UP/DOWN C - Bed Height UP/DOWN D - Nurse Call E - Toggle Underbed Light ON/OFF</p> |
|  | Mattress Please contact Amico Beds for more information | <p>⚠ WARNING: Mattress dimensions must not be smaller than 84" long x 36" wide x 6" thick. Failure to adhere to these dimensions may result in non-compliance to entrapment guidelines as outlined by IEC 60601-2-38, thus increasing the risk of patient injury or death.</p> |
|  | Removable I.V. Pole (optional) S-X-IVPOLE-R | <p>To Install</p> <ul style="list-style-type: none"> • Locate the I.V. pole plastic insert at any of the 4 corners of the bed. • Insert the base of the pole into the hole. <p>To Use</p> <ul style="list-style-type: none"> • Raise the pole by grasping the telescopic section with one hand and loosening the knob with the other hand. • Once the desired height is reached, tighten the knob and the flip down the hooks. <p>To Remove</p> <ul style="list-style-type: none"> • Flip up all of the hooks and lower the telescopic section. • Grasp the main body of the I.V. pole and pull up to remove the entire pole. <p>⚠ CAUTION: Do not exceed the 15 lb. max. weight capacity.</p> |

NOTE: The accessories above are only for use with the Apollo MS bed. It is NOT recommended to use accessories that are not designed for the Apollo MS bed. Failure to comply could result in personal injury or equipment damage, and may void the product's warranty.

Replacement Parts List

| Part Image | Part Description | Part Number |
|---|-----------------------------|----------------------|
|  | Roller Bumper | B-X-BUMPER-ROLLER |
|  | ETS Plastic Bushing | B-X-PBUSHING-ETS |
|  | IV Pole Plastic Insert | S-X-PBUSHING-IVPOLE |
|  | FB Plastic Insert | B-X-PBUSHING-FB |
|  | FB Plastic Insert - Slotted | B-X-PBUSHING-FB-SL |
|  | Footboard PCB Support | B-X-SUPPCB-FOOT-VER3 |
|  | Foot Extender Seam Cover | B-X-SEAMCOVER |
|  | Control Unit Cover | B-X-CTRBOXCVR |
|  | Base Cover - Foot | B-X-BASECVR-FOOT |

Replacement Parts List

| Part Image | Part Description | Part Number |
|---|-------------------------------|----------------------|
|  | Base Cover - Head | B-X-BASECVR-HEAD |
|  | Base Cover - Right Side | B-X-BASECVR-RIGHT |
|  | Base Cover - Left Side | B-X-BASECVR-LEFT |
|  | Caster Arm Bushing | B-X-PBUSHING-CASTARM |
|  | Lower Long Arm Cover - Top | B-PCOVER-LARMS-001 |
|  | Lower Long Arm Cover - Bottom | B-PCOVER-LARMS-002 |
|  | Upper Long Arm Cover - Left | B-PCOVER-UARMS-001 |
|  | Upper Long Arm Cover - Right | B-PCOVER-UARMS-002 |
|  | Siderails - Head Left | B-4000-SRAIL-LHEAD |
|  | Siderails - Foot Left | B-4000-SRAIL-LFOOT |

Replacement Parts List



| Part Image | Part Description | Part Number |
|---|--|--------------------|
|  | Siderails - Head Right | B-4000-SRAIL-RHEAD |
|  | Siderails - Foot Right | B-4000-SRAIL-RFOOT |
|  | Tente© Caster 5" Total Lock Unidirectional | B-CAS-UNI-05B1 |
|  | Tente© Caster 5" Total Lock Directional | B-CAS-DIR-05B1 |
|  | Brake Pedal | S-X-BRAKE-PEDALP |
|  | Foot Roller | B-X-FOOT-ROLLER |
|  | Footboard | B-FOOTBOARD |
|  | CPR Release Cable | B-CPR-CABLEASSY |
|  | Head End Cover | B-X-ENDCVR-HEAD |
|  | Foot End Cover | B-X-ENDCVR-FOOT |

Replacement Parts List

| Part Image | Part Description | Part Number |
|---|--------------------------------|---------------------|
|  | Fowler Gas Spring | B-X-GASSPRING-400 |
|  | Siderail Plate Cover | |
|  | Siderail Middle Linkage Covers | |
|  | Footboard Connector | B-X-CABLE-FOOTBOARD |
|  | LINAK DC Actuator – Fowler | B-X-ACT-01-FOWLER |
|  | LINAK DC Actuator – Knee | B-X-ACT-01-KNEE |
|  | LINAK DC Actuator – Hi-Lo | B-X-ACT-01-HILO |

NOTE: If you require a part that does not appear in the “Replacement Parts List” please contact your Amico Sales Executive for assistance.

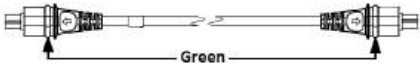
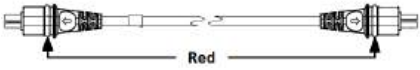
Cables

| Cable Image | Cable Description | Part Number |
|---|--|-----------------------|
|  | LINAK – Footboard Cable | B-X-CABLE-HB |
|  | LINAK – Extension Cable – Green O-Ring | B-X-CABLE-EXTENSION-G |
|  | LINAK – Extension Cable – Red O-Ring | B-X-CABLE-EXTENSION-R |
|  | Power Supply Cord (120V) 126" long cord w/12" pigtail for Grounding | H-X-PCORD-10-NA |
|  | 37-pin Nurse Call Connector 72" long | B-X-CBL-37PIN-06 |



WARNING: It is NOT recommended to use cables that are not designed for the B-AM1-400X bed. Failure to comply could result in personal injury or equipment damage, and may void the product's warranty.

Electromagnetic Compatibility

This product conforms to the EMC standard IEC 60601-1-2 (3rd Edition).

NOTE:

- This product needs special precautions regarding EMC and needs to be installed and put into service according to the EMC information provided below.
- Mobile RF communications equipment can affect the product.
- The use of accessories and cables other than those supplied with the product as replacement parts, with exception for cables sold by Amico Beds Corporation, may result in increased emission or decreased immunity of the product.
- This product should not be used adjacent to or stacked with other equipment. If adjacent or stacked use is necessary, the product should be observed to verify normal operation in the configuration in which it will be used.

Table A.1 – Electromagnetic Emissions

| The Apollo Bed (B-AM1-400X) is intended for use in the electromagnetic environment specified below. The customer or user of B-AM1-400X should assure that it is only used in such an environment. | | |
|---|----------------|---|
| Emission Test | Compliance | Electromagnetic Environment – Guidance |
| RF Emissions CISPR11 | Group 1 | The Apollo Bed (B-AM1-400X) uses RF energy only for its internal function. Therefore, its RF emissions are very low and are not likely to cause any interference in nearby electronic equipment. |
| RF Emissions CISPR11 | Class A | The Apollo Bed (B-AM1-400X) is suitable for use in all establishments other than domestic and those directly connected to public low voltage power supply network that supplies buildings used for domestic purposes. |
| Harmonic Emission IEC 61000-3-2 | Not Applicable | |
| Voltage Fluctuation/Flicker Emission IEC 61000-3-3 | Not Applicable | |

Electromagnetic Compatibility

Table A.2 – Electromagnetic Immunity

| The Apollo Bed (B-AM1-400X) is intended for use in the electromagnetic environment specified below. The customer or user of B-AM1-400X should assure that it is only used in such an environment. | | | |
|---|---|---|--|
| Immunity Test | IEC 60601 Test Level | Compliance Level | Electromagnetic Environment – Guidance |
| Electrostatic Discharge (ESD) IEC 61000-4-2 | ± 6 kV contact ± 8 kV air | ± 6 kV contact ± 8 kV air | Floors should be wood, concrete or ceramic tile. If floors are covered with synthetic material, the relative humidity should be at least 30%. |
| Electrical fast transient/burst IEC 61000-4-4 | ± 2 kV for power supply lines ± 1 kV for input/output lines | ± 2 kV for power supply lines ± 1 kV for input/output lines | Main power quality should be that of a typical commercial or hospital environment. |
| Surge IEC 61000-4-5 | ± 1 kV line(s) to line(s) ± 2 kV line(s) to earth | ± 1 kV differential mode ± 2 kV common mode | Main power quality should be that of a typical commercial or hospital environment. |
| Voltage dips, short interruptions and voltage variations on power supply input lines IEC 61000-4-11 | <5% U_T (>95% dip in U_T) for 0.5 cycle 40% U_T (60% dip in U_T) for 5 cycle 70% U_T (30% dip in U_T) for 25 cycle <5% U_T (>95% dip in U_T) for 5 s | <5% U_T (>95% dip in U_T) for 0.5 cycle 40% U_T (60% dip in U_T) for 5 cycle 70% U_T (30% dip in U_T) for 25 cycle <5% U_T (>95% dip in U_T) for 5 s | Main power quality should be that of a typical commercial or hospital environment. If the user of the Apollo Bed (B-AM1-400X) requires continued operation during main power interruptions, it is recommended that the Apollo Bed (B-AM1-400X) be powered from an uninterruptible power supply or a battery. |
| Magnetic field at power frequency IEC 61000-4-8 | 3 A/m | 3 A/m | Power frequency magnetic fields should be at levels characteristic of a typical location in a typical commercial or hospital environment. |
| NOTE: U_T is the A.C. main voltage prior to application of the test level. | | | |

NOTE: This medical device is a patient support and handling device with an electro-mechanical system, able to achieve various heights and positions for the litter sections as required per the end user. The device meets this essential performance at the above compliance levels.

Electromagnetic Compatibility

Table A.3 – Electromagnetic Immunity

The Apollo Bed (B-AM1-400X) is intended for use in the electromagnetic environment specified below. The customer or user of B-AM1-400X should assure that it is only used in such an environment.

| Immunity Test | IEC 60601 Test Level | Compliance Level | Electromagnetic Environment – Guidance |
|-------------------------------|------------------------------------|------------------|--|
| Conducted RF IEC 61000-4-6 | 3 Vrms (from 150 kHz to 80 MHz) | 3 Vrms | <p>Portable and mobile RF equipment should be used no closer to any part of the B-AM1-400X (including cables) than the recommended separation distance calculated from the equation applicable to the frequency of the transmitter. Recommended separation distance:</p> <p>$d = 1.2 \times \sqrt{P}$ from 150 kHz to 80 MHz</p> <p>$d = 1.2\sqrt{P}$ (for 80MHz to 800 MHz)</p> <p>$d = 2.3\sqrt{P}$ (for 800 MHz to 2.5 GHz)</p> <p><i>P</i> is the maximum output power rating of the transmitter in watts (W) according to the transmitter manufacturer and <i>d</i> is the recommended separation distance in metres (m)^b.</p> <p>Field strengths from fixed RF transmitters, as determined by an electromagnetic Site survey^a, should be less than the compliance level in each frequency range^b.</p> <p>Interference may occur in the vicinity of equipment marked with the following symbol:</p>  |
| Radiated RF IEC 61000-4-3 | 3 V/m (from 80 kHz to 2.5 GHz) | 3 V/m | |

NOTE 1: At 80 MHz and 800 MHz, the higher frequency range applies.

NOTE 2: These guidelines may not apply in all situations. Electromagnetic propagation is affected by absorption and reflection from structures, objects, and people.

^a: Field strengths from fixed transmitters such as base stations for radio (cellular/cordless) telephones and land mobile radios, amateur radio, AM and FM radio broadcast and TV broadcast cannot be predicted theoretically with accuracy. To assess the electromagnetic environment due to fixed RF transmitters, an electromagnetic site survey should be considered. If the measured field strength in the location in which the Apollo Bed (B-AM1-400X) is used exceeds the applicable RF compliance level above, the Apollo Bed (B-AM1-400X) should be observed to verify normal operation. If abnormal performance is observed, additional measures may be necessary, such as re-orienting or relocating the Apollo Bed (B-AM1-400X).

^b: Over the frequency range 150 kHz to 80 MHz, field strengths should be less than 3 V/m.

Electromagnetic Compatibility

Table A.4 – Recommended Separation Distances

| Recommended separation distances between portable and mobile RF communications equipment and the Apollo Bed (B-AM1-400X). | | | |
|--|---|--|---|
| The Apollo Bed (B-AM1-400X) is intended for use in the electromagnetic in which radiated RF disturbances are controlled. The customer or user of the Apollo Bed (B-AM1-400X) can help prevent electromagnetic interference by maintaining a minimum distance between portable and mobile RF communications equipment (transmitters) and the Apollo Bed (B-AM1-400X) as recommended below, according to the maximum output power of the communications equipment. | | | |
| Rated Maximum Output Power of Transmitter (W) | Separation Distance According to the Frequency of Transmitter (m) | | |
| | from 150kHz to 80MHz $d= 1.2 \times \sqrt{P}$ | from 80MHz to 800MHz $d= 1.2 \times \sqrt{P}$ | from 800MHz to 2,5GHz $d= 2.3 \times \sqrt{P}$ |
| 0.01 | 0.12 | 0.12 | 0.23 |
| 0.1 | 0.38 | 0.38 | 0.73 |
| 1 | 1.2 | 1.2 | 2.3 |
| 10 | 3.8 | 3.8 | 7.3 |
| 100 | 12 | 12 | 23 |
| For the transmitters rated at a maximum output power not listed above, the recommended separation distance d in meters (m) can be estimated using the equation applicable to the frequency of the transmitter, where P is the maximum output power rating of the transmitter in Watts (W) according to the transmitter manufacturer. | | | |
| NOTE 1: At 80 MHz and 800 MHz, the separation distance for the higher frequency range applies. | | | |
| NOTE 2: These guidelines may not apply in all situations. Electromagnetic propagation is affected by absorption and reflection from structures, objects and people. | | | |

EMI Information (FCC)

This device complies with Part 15 of the FCC Rules. Operation is subject to the following two conditions:

(1) this device may not cause harmful interference, and (2) this device must accept any interference received, including interference that may cause undesired operation.

NOTE: This equipment has been tested and found to comply with the limits for a Class A digital device, pursuant to Part 15 of the FCC Rules. These limits are designed to provide reasonable protection against harmful interference when the equipment is operated in a commercial environment. This equipment generates, uses and can radiate radio frequency energy and, if not installed and used in accordance with the instruction manual, may cause harmful interference to radio communications. Operation of this equipment in a residential area is likely to cause harmful interference in which case the user will be required to correct the interference at his own expense.



WARNING: Changes or modifications not expressly approved by Amico Beds Corporation could void the user's authority to operate the equipment.



Warranty Policy - Beds and Stretchers

Amico Beds Corporation warrants its Patient Equipment to be free from defects in material and workmanship for a period of twelve (12) months from the date of shipment. Within this period Amico Beds Corporation will provide the parts for repair or replacement of defective parts at Amico Beds Corporation cost.

Shipping and Installation costs after the first twelve (12) months will be borne by the Customer.

This warranty is valid only when the product has been properly installed according to Amico Beds Corporation specifications, used in a normal manner and serviced according to factory recommendations. It does not cover failures due to damage which occurs in shipments or failures which result from accidents, misuse, abuse, neglect, mishandling, alteration, misapplication or damage that may be attributable to acts of God.

Amico Beds Corporation shall not be liable for incidental or consequential damages resulting from the use of the equipment.

Notas

Notas

www.amico.com

Amico Beds Corporation | 85 Fulton Way, Richmond Hill, ON L4B 2N4, Canada
Toll Free Tel: 1.877.462.6426 | Tel: 905.764.0800 | Fax: 905.764.0862
Email: info@amico.com | www.amico.com