

Infa Warmer

Radiant Warmer



To Save a Tiny Baby Life

From Delivery Room to NICU

Meets wide needs with substantial functions and features.
Through add-on unit, two kinds of resuscitation unit are available depending on user's demand.



Infa Warmer *i*



Ease of Use



Temperature Control



Safety Function



Resuscitation Function



Ease of Use

Surgical operations can be performed safely in the NICU.



*Drawer is optional



Touch panel type display with excellent operability and functionality.

- The screen can be switched smoothly by intuitive operation.
- Visibility of weight measurement and alarm indication has improved.
- The pre-heat function can keep the mattress warm before use.



X-ray cassette tray accessible from 3 directions.

- X-ray cassette can be taken in and out from 3 directions, which does not interfere with the arrangement of peripheral devices.



Temperature Control

The infant's skin temperature can be prevented from falling.



Convenient preheating function to warm the mattress sufficiently in an emergency.

- Postnatal care can be given on pre-heated warm mattress.

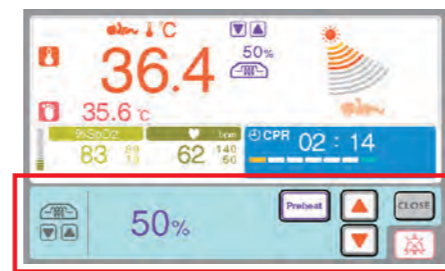

Far infrared heater warms the mattress surface uniformly.

- The heater reflector improves the warming performance which leads to stable body temperature control.



The canopy can be tilted independently.

- The examination light always illuminates the treatment space according to the inclination of canopy, temperature control.

Safety Function

Long-term management with less stress to the infant.



Detachable baby guard enables easy complete cleaning.

- The baby guard taking measures against blood invasion can be easily detached without tools and it reduces troubles of cleaning and maintenance.

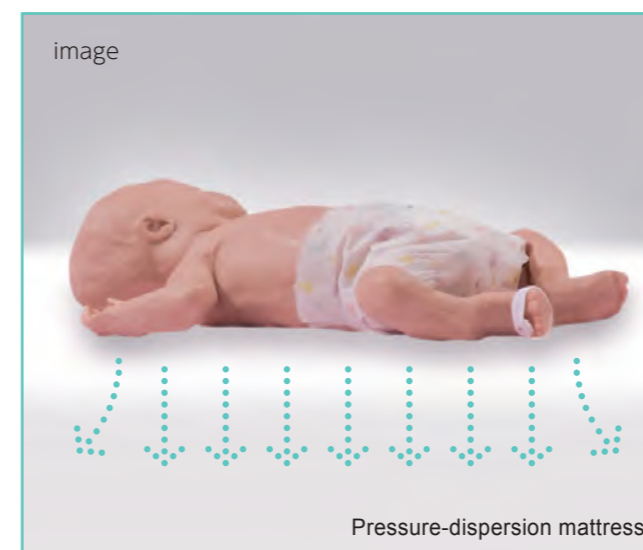

Pressure-dispersion mattress to provide stable and comfortable resting and sleeping surface.

- The pressure-dispersion mattress reduces the infant's stress by minimizing bedsores.



Baby Guard

- Thanks to rotary damper, the baby guard can be opened very silently without touching.

Resuscitation
Function

Support smooth neonatal resuscitation



Supports safe artificial ventilation.
(Blender Unit 105) <Add-on unit>

- Built-in oxygen blender and manometer supports manual ventilation, such as during replacement of breathing circuit.



Simple operation supports resuscitation.
(Resuscitation Unit 104) <Add-on unit>

- By placing a face mask on the newborn, the user has the ability to control the inspiratory time by placing a finger on T Flow Valve.

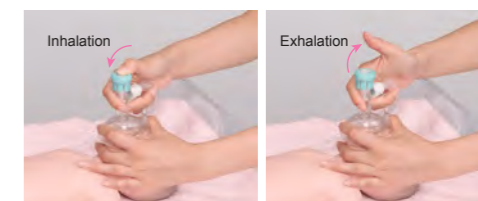

Simple operation with a thumb

The pulse oximeter is available as user's demand. <Add-on unit>

- The pulse oximeter makes administration of oxygen easy and safe.

CPR Timer

- Inform the timing to assess the health condition of newborn every 30 seconds.



Useful weight measurement with display operation. <Add-on unit>

- The infant's weight can be simply measured by laying the infant on mattress following to the guide on the display, which reduces infant's stress caused by handling.



Options



atom's code 61580
Power Pack i AC120V
atom's code 61581
Power Pack i AC230V



atom's code 60988
Drawer w/mounting bracket

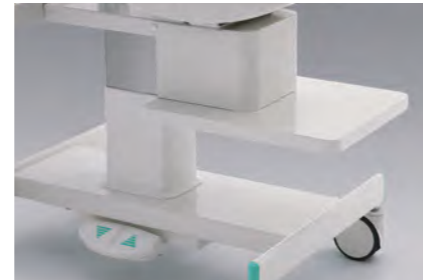

atom's code 61627
Open Rack



atom's code 23629
Gastroschisis support arm w/Bracket

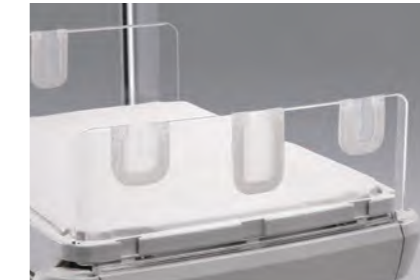

atom's code 23623
Baby Guard w/Inlet Packing



atom's code 23628
Handle
(Mattress Platform Mounting Type)



atom's code 61617
Tray Set for F-Rail
atom's code 61618
Tray Set (S) for F-Rail



atom's code 60216
Infa Lite AC100-240V



atom's code 61642
Drainage Hanger (2 pcs/pkg)



atom's code 60895
Cylinder Rack for F-Rail (1 pce)



atom's code 23624
Inner Panel 3 pcs/set



atom's code 60899
Handle for F-Rail (2 pcs/set)



atom's code 60894
Basket w/arm for F-Rail



atom's code 23719
Multi Holder (Baby guard mounting type)



atom's code 61071
Cord Holder for F-Rail (5 pcs/pkg)



atom's code 60349
Monitor Table for F-Rail



atom's code 60350
Monitor Table
for Philips monitor for F-Rail

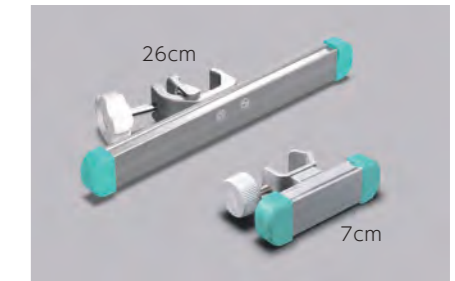

atom's code 60306
MF-Rail, 7cm Pole mounting type
atom's code 60367
MF-Rail, 26cm Pole mounting type



atom's code 61616
MF-Rail for F-Rail (Left & Right)



atom's code 23627
Tube Holder
(Mattress Platform Mounting Type)
atom's code 60871
Tube Holder
(Baby guard Mounting Type)



atom's code 60893
I.V Pole for F-Rail

Product Lineup

Infa Warmer *i* Atom Infant Warmer 103

Main Unit	
Atom's code	Power requirements
61633	AC120V ± 10%
61634	AC230V ± 10%

Add-on Unit	
Atom's code	Description
61663	SpO ₂ Unit (Masimo)
61664	SpO ₂ Unit (Nellcor)
61650	Resuscitation Unit P type*1
61651	Resuscitation Unit E type*2
61652	Blender Unit P type*3
61653	Blender Unit E type*4
23631	Weight Monitor Unit

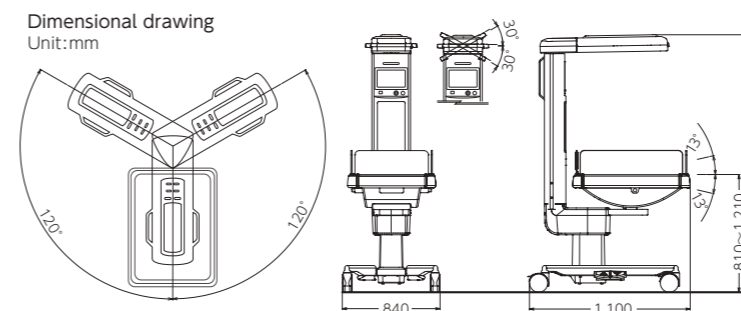

- <Note>**
- *1:T-Piece Resuscitation Unit with Blender and Suction Unit (connect to central piping system)
 - *2:T-Piece Resuscitation Unit with Blender and Suction Unit of ejector type to make suction operation possible where no suction piping is available
 - *3:O₂ Blender Unit and Suction Unit (connect to central piping system)
 - *4:O₂ Blender Unit and Suction Unit of ejector type to make suction operation possible where no suction piping is available

Specifications

Power requirements	Customer specified	Heater output setting range	0~100% (in 5% increments)
Power consumption	700VA	Heater output indication	In 10 levels
Type/Degree of protection	Class I/Type BF applied part	Skin temp. setting range	34.0~38.0°C / 93.2~100.4°F (in 0.1°C/°F increments)
Display	Type : Liquid crystal (TFT-LCD) Dot formation : 800×480dots Number of colors : 256colors	Skin temp. display range	30.0~42.0°C / 86.0~107.6°F (in 0.1°C/°F increments)
Heater capacity	500W	Skin temp. display accuracy	±0.3°C / ±0.5°F
Dimensions	Main body : 840(W)x1100(D)x1790~2190(H) mm Mattress : 500(W)x700(D)x25(H) mm	Timer	0~60 minutes 00 second (in one second increments) Apgar mode / CPR mode selectable
Mattress surface	810~1210 mm	Mattress platform tilting	Longitudinal tilt of ±13°(freely adjustable)
Weight	Approx. 105Kg	Canopy mobility range	Horizontal rotation : 240°(120°both sides) Radiation angle : ±30°
Accessories	Skin temp. probe 1 Mattress sheet 1 Dust cover 1 Cover baby 3 Pressure dispersion mattress 1 Cord holder 2 Power cord 1 Operation Manual 1	Lighting	LED lighting, intensity adjustable, 0~1200Lx
		Preheat	Available
		Alarms	Set temp., Baby check, Power failure, System failure, Skin temp. probe, Canopy tilt

Specifications (Add-on Unit)

SpO₂ Unit [Masimo/Nellcor]

SpO ₂	Display range:1~100% Accuracy (in 70-100%)±3digits Alarm function setting range:Upper limit 50~99%, OFF Lower limit 45~95%, OFF
Pulse rate	Display range:25~240bpm Accuracy (in 25-240bpm)±3digits Alarm function setting range:Upper limit 80~240bpm, OFF Lower limit 35~180bpm, OFF
Mode (Masimo) (Nellcor)	Averaging time:4,6,8,10,12,14,16sec. Sensitivity setting:APOD, Normal, Max FastSat:ON, OFF SatSeconds:10,25,50,100, OFF Response:Normal, Fast

Resuscitation Unit 104

General	Pressure indication: -2~8kPa (-20~80cmH ₂ O)
Suction unit	Suction pressure control range:0~26.7kPa (0~200mmHg)
Oxygen blender / flow meter unit	Oxygen concentration range:21~100% Flow rate range:0~15L/min
Resusci Flow unit	Maximum pressure limit (PMAX) setting range:2.0~5.9kPa (20~60cmH ₂ O) Default setting:3.9kPa (40cmH ₂ O)
Accessories	Patient Circuit 1 Test Bag, 50mL 1 Piping Connecting Hose for Air 1 Piping Connecting Hose for Oxygen ... 1 Outlet Connecting Hose for Air/Oxygen ... 1 Oxygen Supply Hose 1 Face Mask for Neonatal 1 Face Mask for Infant 1 Oxygen Humidifier Jar Holder 1 Humidifier Bottle OX-230 1 Outlet Connecting Hose for Suction 1 Piping Connecting Hose for Suction ... 1 Suction Jar Holder 1 Suction Canister, 500mL 1 Dispo Liner, 500mL 1 Suction Hose 1 Silencer (for E-type)..... 1 Operation Manual 1

Blender Unit 105

General	Pressure indication: -2~8kPa (-20~80cmH ₂ O)
Suction unit	Suction pressure control range:0~26.7kPa (0~200mmHg)
Oxygen blender / flow meter unit	Oxygen concentration range:21~100% Flow rate range:0~15L/min
Accessories	Piping Connecting Hose for Air ... 1 Piping Connecting Hose for Oxygen ... 1 Outlet Connecting Hose for Air / Oxygen ... 1 Oxygen Supply Hose 1 Tube for Pressure Measurement 1 Oxygen Humidifier Jar Holder 1 Humidifier Bottle OX-230 1 Outlet Connecting Hose for Suction ... 1 Piping Connecting Hose for Suction 1 Suction Jar Holder 1 Suction Canister, 500mL 1 Dispo Liner, 500mL 1 Suction Hose 1 Silencer (for E-type)..... 1 Operation Manual 1

Weight Monitor

Weighing range	300~7000g
Scale interval	1g (weight monitor without official verification) 5g (weight monitor with official verification)



Atom Medical products are produced under strict production control in Japan.
We provide value and trust of the highest quality for the tiny baby lives in the world.

Manufacturer: ATOM MEDICAL CORPORATION

18-15, Hongo 3-chome, Bunkyo-ku, Tokyo, 113-0033 JAPAN
<http://www.atomed.co.jp>

Exporter: ATOM MEDICAL INTERNATIONAL, INC.

SWT Bldg., 15-9 Hongo 3-chome, Bunkyo-ku, Tokyo, 113-0033 JAPAN
Phone: + 81 3 3815 2941 Fax: + 81 3 3812 9670/4080