



# Equipping Medical & Rescue Professionals

PRODUCT  
CATALOG  
2021

**PREMIUM  
EMS BACKPACK  
WITH CLEAR POCKETS**  
Item# 10-115-RED-CLR  
See pg. 12



**NEW**  
Clear Hip Pack with mesh drain  
Item# 10-103-CLR  
See pg. 43



**NEW**  
50" Mesh Rescue Tube  
Item# 10-201-RED-MESH  
See pg. 59



## Serving EMS, Lifeguard & Swim Industries

**NEW**  
Medical Supply Packs  
for EMS Bags  
See pg. 18



**NEW**  
Wood TG Spineboard  
Item# 10-981  
See pg. 30



80% Gray Wool Blanket  
Item# 10-606  
See pg. 6



BRAVERY  
**HEROES**  
Nurses **Thank You** **COURAGEOUS**  
COURAGE  
Doctors  
Frontline Workers Farmers  
DEDICATION Healthcare Workers  
COMMITMENT **Thank You** Hospitals  
**Thank You**  
Emergency Medical Services  
Police **COMPASSION** Military  
Fire Fighters Truck Drivers  
Paramedics Maintenance  
**SELFLESS**  
Cleaners  
GRIT

- Kemp USA Team



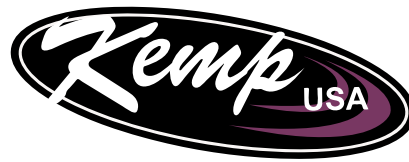

Dear Customer,

Kemp USA is recognized in the EMS, Lifeguard, and Swimming industry for our exceptional customer service and high quality safety products. Our company began manufacturing 14 years ago, catering to dealers and distributors. Over that short time, guided improvements on our superior products have evolved and expanded the Kemp USA brand - thanks to you, our customer. By responding to your changing wants and needs, we've been able to offer only the best products that really work for you. The team here at Kemp USA is committed to our dealers and distributors, always striving to go above and beyond industry standards and expectations. At Kemp USA, we are always looking for ways to streamline order processing, fulfillment, and efficient shipping methods. We are EDI compliant and have deep discounted shipping rates with our carriers. We can also dropship your orders directly to your customer. Be sure to check our website for further detailed information about new product releases at [www.KempUSA.com](http://www.KempUSA.com).

Eddie H. Gulbenkian, III  
Chief Executive Officer  
Kemp USA



Kemp USA Headquarters  
Charlotte, NC, USA



**Over 50,000  
square feet  
of inventory  
in stock and  
ready to ship.**



# Authorized Dealers



Bound Tree



MDSupplies





Serving EMS, Lifeguard, and Swim Industries

# TABLE OF CONTENTS

## Emergency Medical Services

**Blankets** .....6  
Emergency, Disaster, Fleece, Mylar, Wool

**CPR** ..... 7-9  
CPR, Resuscitation, Training, Masks

**EMS Gear Bags** .....10-22  
Premium Line EMS Bags ..... 10-13  
EMS Gear Bags Continued ..... 14-16  
Specialty Bags (Intubation, Firefighter, Fire Blanket, Drug Pouch) ..... 17  
Medical Supply Packs for EMS Bags ..... 18-22

**First Aid** ..... 23-27  
Bleeding Control, Bloodborne Pathogen & PPE Kits..... 23  
First Aid Kits, NJ Approved Kits..... 24  
First Aid Supplies & Virus Protection..... 25-27

**Patient Immobilization** ..... 28-36  
Immobilizers..... 28-29  
Spineboards & Stretchers..... 30-34  
Spineboard Straps..... 35-36  
Speedboard Bag, Collar Bags, Mounting Bracket ..... 36

## Lifeguard & Swim

**Water Rescue** ..... 37-41  
Rescue Tubes & Rescue Cans ..... 37-39  
Ring Buoys ..... 39-40  
Throwlines ..... 40  
Life Vests ..... 41

**Guard Gear & Apparel** .....42-48  
Hip Packs ..... 42-43  
Megaphones ..... 44  
Umbrellas ..... 44-45  
Whistles & Lanyards ..... 45-46  
Guard Apparel ..... 47-48

**Swim & Aquatics** .....48-52  
Diving Brick, Bungee Cords, Backstroke Flags ..... 48-49  
Swim Caps, Kickboards, Swim Aids ..... 50-51  
Water Aerobic Exercise ..... 51  
Pool Floats ..... 52

## Other

**New Items** ..... 53-59  
**Index** ..... 60-66  
**Terms & Conditions**.....67

## EMERGENCY BLANKET

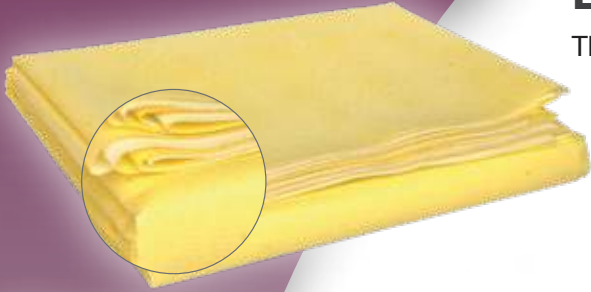

The emergency blanket has a soft inner-tissue lining, great for body warmth maintenance, and a water-resistant shell for protection during emergencies. It can also double as a shelter, poncho/raincoat, snowmobile accessory, S.O.S.beacon or flag. Travel friendly, compact, and lightweight.

Item # 10-602	Color: Yellow	Dimensions: 60" x 72"
Shipping: 9.25" x 3"	Weight: 1 lb	

## KEMP USA WOOL BLANKET



The Kemp USA wool blanket is a great multipurpose blanket. As a few examples, this blanket has been spotted in action for disaster relief, humanitarian aid, in hospitals, for military use, as hotel standbys, and donation blankets.

30% Wool Item # 10-604	75% & 100% Wool Available	
50% Wool Item # 10-605		
80% Wool Item # 10-606		
Color: Gray	Dimensions: 60" x 84"	Shipping: 9.25" x 3"
Weight: 30% - 3 lbs, 50% - 4 lbs, 80% - 5 lbs		

Most Popular!



## KEMP USA GRAY RELIEF BLANKET

The Kemp USA relief blanket is a great multipurpose blanket. Made of 100% synthetic fibers (cotton, acrylic and polyester). For Emergency Disasters Preparedness: EMS Professional - Ambulance Supply - Earthquakes - Hurricanes - Floods - Tornadoes - Blizzards - Emergency Medical. A great blanket at a great price.

Item # 10-600	Color: Gray	Dimensions: 60" x 84"
Shipping: 13" x 18" x 13"	Weight: 3 lbs	

## KEMP USA MYLAR BLANKET



The Kemp USA foil blanket is a lightweight multipurpose first aid blanket for body warmth maintenance, emergency shelter, protection from weather, or reflective distress signal. The aluminized, non-stretch polyester reflects body heat back to the user and stays flexible in freezing temperatures. It's extremely lightweight and compact, and fits easily into first aid kits, hip packs, pockets, bags, and glove compartments. It's windproof and waterproof and will not rot or mildew. High volume quantities available.

Item # 10-601	Color: Silver Foil	Dimensions: 60" x 72"
Shipping: 9.25" x 7" x 3"	Weight: 1 lb	



## KEMP USA FLEECE BLANKET

The Kemp USA fleece blanket is 100% polyester; features trim with matching whipstitch, and is machine washable and dryable. Makes a great gift.

Item # 10-608	Color: Maroon, Navy Blue	Dimensions: 60" x 84"
Shipping: 17.5" x 6.5" x 11.5"	Weight: 3 lbs	



Kemp USA has a great variety of CPR equipment for training and the frontlines. We carry high quality products that are proven to save lives, such as CPR Masks, Manikins, Training Valves, and more. Check out our First Aid section as well on page 23-27. Our stock supplies are readily available to be shipped.

### RAPID SEAL RESUSCITATION MASK

This mask is a must for in-water resuscitation. Comes pre-inflated and delivers a perfect seal with the patient every time. Made of a durable high-density plastic and has a comfortable grip. This mask is good for adults or children and is FDA registered.

Item # 10-527	Color: Clear	Dimensions: 7" x 4.5" x 4.5"
Shipping: 10" x 7" x 3"	Weight: 1 lb	

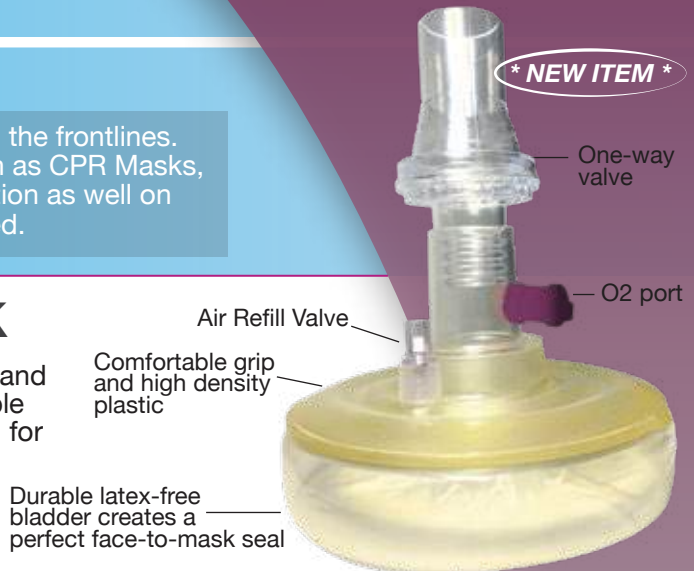

### KEMP USA HEPA FILTER FOR CPR

The Kemp USA HEPA filter can be used on any of our CPR masks or BVMs. It adds an extra layer of protection against the spread of viruses. This filter has bi-directional airflow and is disposable for single patient use only.

Item # 10-543	Color: Blue	Dimensions: 3.5" x 3" x 2"
Shipping: 9" x 6" x 4"	Weight: 0.1 lbs	



### KEMP USA CPR BOARD

The Kemp USA CPR Board is ideal for CPR training and CPR administration by providing a firm surface that helps to properly position a patient. It also helps to ensure a constant open airway. The head cup maintains proper alignment of a patient's head, while the contoured sides make lifting the patient easier.

Item # 10-518	Color: Orange	Dimensions: 23.75" x 16.25" x 2.75"
Shipping: 17" x 24" x 3"	Weight: 3.3 lbs	Case Qty: 6



### AMBU BAG VALVE MASKS (BVM)

The AMBU line of BVMs is the only resuscitator that is made from a SEBS material instead of PVC. The AMBU BVM provides users with exceptional tactile and visual feedback during resuscitation. The bag is highly responsive, with minimal mechanical resistance-some even says it's a natural extension of the hand. The convenient handle makes it easier to hold the unit and to ventilate a patient with just one hand, if necessary. The characteristic design provides optimum stroke volume with perfect recoil, yet is smaller and lighter than most other disposable units. We also have the HEPA filter option.

Adult Item # 10-507	
HEPA Adult Item # 10-507-HEPA	
Infant Item # 10-508	
Pediatric Item # 10-509	
Color: Clear	Dimensions: 24" x 17" x 3"
Shipping: 12.5" x 12.5" x 8.25"	Weight: 2 lb





## KEMP USA ROYAL BLUE TRAINING VALVE

Single use training valves are an economical alternative to replacement valves when teaching with rescue masks. This valve fits adult, child, and infant rescue masks and has a unique filter to mimic the breath needed to give mouth to mouth. Valves are individually wrapped and sold in packs of 10. For training use only.

<b>Item # 10-528-ROY</b>		
<b>Dimensions:</b> 4.25" x 2.75" x 4.25" (Pack of 10)		
<b>Shipping:</b> 9" x 7.5"	<b>Weight:</b> 0.50 lb	<b>Sold in packs of 10 units.</b>



## ONE WAY VALVE & FILTER FOR CPR MASKS

This is the replacement valve for the Kemp USA 10-501 CPR mask. This also works with the Ambu masks as well. Includes a filter and is intended for single use.

<b>Item # 10-510</b>	<b>Color:</b> Clear
<b>Shipping:</b> 10" x 7" x 3"	<b>Weight:</b> 1 lbs



## CPR PROMPT 7-PACK MANIKINS

These professional training manikins are designed to teach CPR and lifesaving skills. These manikins make it affordable for instructors to provide a one-student-to-one-manikin ratio; the equivalent of 10,000 student usages. Its soft foam-based construction makes the manikin extremely lightweight. The 7-pack kit includes 5 adult and 2 infant manikins, 150 lungs bags, and carrying case.

<b>7-Pack Manikins</b> Item # 10-519	
<b>Replacement Lung Bags</b> Item # 10-520 (Adult) #10-521 (Infant)	
<b>Dimensions:</b> 28.5" x 13.5" x 9.5" (Manikins)	
<b>Shipping:</b> 29" x 16" x 20"	<b>Weight:</b> 33 lbs



## KEMP USA COMPETITION MANIKIN

The Kemp USA Competition manikin is the only manikin made in North America that complies with (ILS) International Lifesaving Federations specifications. This also is one of just five manikins in the world approved for use in ILS sanctioned competitions. No other manikin in North America is approved. This manikin features non-fade, non-chip paint. Spin welded one size fittings prevent water leakage. Secured non-removable weight to eliminate risk of loss. New location of middle plug allows you to fill and drain manikin to the precise location. No more guessing, shaking or time delays in event setups.

<b>Item # 10-297</b>	<b>Color:</b> Orange	<b>Dimensions:</b> 18.5" x 9" x 40.25"
<b>Shipping:</b> 19" x 9" x 41"		<b>Weight:</b> 17 lbs



## KEMP USA TRAINING MANIKIN

The Kemp USA Training Manikin is an easy to fill and drain lifesaving rescue training manikin. It's ideal for lifesaving courses, lifeguard training, employer screenings and lifesaving sport athletes. This manikin is open at the bottom and fills with water easily and submerges to simulate an unconscious victim. It's virtually indestructible, light weight and portable.

<b>Item # 10-298</b>	<b>Color:</b> Orange	<b>Dimensions:</b> 18.5" x 9" x 40.25"
<b>Shipping:</b> 19" x 9" x 41"		<b>Weight:</b> 17 lbs



### KEMP USA CPR MASK WITH O2 INLET

The Kemp USA CPR Mask is packaged in a compact, hard shell, pocket-sized carrying case and features a one-way valve with filter. It has a contoured soft vinyl cuff that shapes easily to adult, child, and infant facial contours, preventing mouth-to-mouth contact with the victim. Its transparent dome allows the rescuer to check the victim's mouth for lip color and secretions. The mask is ready to use with no need to assemble valve and filter. We can private label them with customer's logo for an extra fee. Please call for private label pricing.

<b>Hard Case Item # 10-501</b>		
<b>Soft Case Pouch Item # 10-514</b>		
<b>Color: White or Red</b>	<b>Dimensions: 6" x 4.5" x 1.75"</b>	
<b>Shipping: 10" x 7" x 3"</b>	<b>Weight: .25 lb</b>	<b>Case Qty: 100</b>



### AMBU CPR MASK WITH OR WITHOUT O2 INLET

The AMBU CPR Mask features an optional patented one-way valve with filter. This mask prevents mouth-to-mouth contact with the victim's face. Its transparent dome allows the rescuer to check the victim's mouth for lip color and secretions. The mask is ready to use with no need to assemble valve and filter, which saves valuable time in emergencies.

<b>With O2 Inlet Hard Case Item # 10-502</b>		
<b>With O2 Inlet Soft Case Pouch Item# 10-517</b>		
<b>Color: Red</b>	<b>Dimensions: 6" x 4.5" x 1.75"</b>	
<b>Shipping: 10" x 7" x 3"</b>	<b>Weight: .25 lb</b>	<b>Case Qty: 80</b>



### AMBU CPR MASK COMBO ADULT & CHILD

This AMBU mask comes in a soft pouch with the child adapter which is proper for giving CPR to small faces. It also includes an O2 inlet.

<b>Item # 10-523</b>	<b>Color: Red</b>	<b>Dimensions: 6" x 4.5" x 1.75"</b>
<b>Shipping: 10" x 7" x 3"</b>		<b>Weight: .25 lb</b>



### KEMP USA CPR MASK COMBO ADULT & CHILD

The Kemp USA Adult and Child Combo CPR Mask comes with our standard 10-501 CPR Mask and includes the child adapter cuff which is proper for giving CPR to small faces. This kit includes nitrile gloves and wipes. The case can be customized with your company logo in volume.

<b>Hard Case Item # 10-525</b>		
<b>Soft Case Pouch Item # 10-526</b>		
<b>Dimensions: 6" x 4.5" x 2"</b>		
<b>Shipping: 10" x 7" x 3"</b>	<b>Weight: .25 lb</b>	<b>Case Qty: 50</b>



### PRIVATE LABEL

We private label in house and it is available on the 10-501 and 10-525 hard case. Private labeling allows for corporate branding and easy identification.



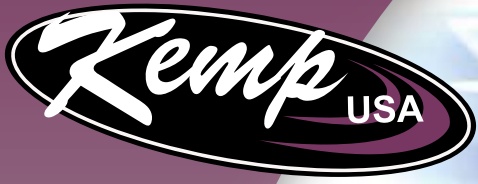

# PREMIUM EMS BAGS

Kemp USA is proud to offer this NEW line of Premium EMS Bags. These bags are built to last, holding up to 150 lbs. Constructed with features such as a durable 1680 denier nylon material, over-sized pull zippers, black nickel hardware, and bar-tacking reinforcement at stress points. We also have a washable Tarpaulin line available. These bags are designed with the user in mind. Kemp USA offers the best stock availability in the industry.

**Premium Professional Trauma Bag**  
Item# 10-104-NVY-PRE  
See Pg. 12



All metal black nickel hardware



Over-sized pull zippers



1680 Denier Nylon

Gel foam shoulder strap cushion

Molded feet on bottom for protection

Pull-out kneel pad

## “Designed with the user in mind”

**Fluid Resistant Ultimate EMS Backpack**  
Item# 10-115-RED-TPN  
See Pg. 12

Bar-tacking at all stress points to reinforce stitching

**Kemp USA now offers the option to outfit all of our EMS bags with Medical Supply Packs.**

Highly visible reflective trim

**Everything you need to be ready on the field and frontlines!**

Washable Tarpaulin material

See itemized medical supply packs on pages 18-22.



## Innovative designs

**Large Responder Bag**  
Fluid resistant with medication pouches.  
Item# 10-125  
See Pg. 14

**Rescue & Tactical Backpack**  
Compact and versatile.  
Item# 10-122  
See Pg. 13

**Ultimate EMS Suitcase**  
Carry-on size with wheels.  
Item# 10-120  
See Pg. 13



## LARGE PROFESSIONAL TRAUMA BAG

The Kemp USA Premium Professional Trauma Bag has been adapted from the best selling, standard professional trauma bag for those seeking an ultra durable bag that will stand up to heavy use. Made with 1680 Denier Nylon, Kemp USA's Premium line of EMS bags are extremely durable and water resistant. High stress points have been cross stitched and bar tacked to increase strength when the bag is fully loaded. High visibility, reflective pull tabs give the rescuer easy access to the compartments, even at night. The tuck away backpack harness allows for multiple carrying options and a gel foam padded shoulder strap for increased comfort. In addition to the standard features, this premium bag features a pull out kneeling pad for the rescuer to use while working on a patient as well as a replaceable bottom. Other features include: Metal black nickel hardware all around. Front pocket with elastic loops and pouches. External, easy-access top pocket, two external side pockets. Internal compartment with removable dividers and zippered see-through pouch. Available in Navy or Red. Washable tarpaulin material also available.



Supply Packs  
Now  
Available

**Premium Red** Item # 10-104-RED-PRE

**Tarpaulin Red** Item # 10-104-RED-TPN

**Premium Navy Blue** Item # 10-104-NVY-PRE

\* Navy Bag  
featured on pg. 10

**Dimensions:** 17.5" x 13" x 10" | **Shipping:** 18" x 12" x 12" | **Weight:** 5 lbs

**Supply Pack Options:** A, B, C, D, E, F - See pages 18-22

10-115-RED-PRE

## ULTIMATE EMS BACKPACK

The Kemp USA Premium Ultimate EMS Backpack is made with 1680 Denier Nylon, the newly designed EMS Backpack is one of the most versatile and affordable EMS backpacks of this quality on the market. The bag features two large front pockets that measure 10" x 13" x 3" and a lower pocket that features elastic loops on the inside. The upper pocket comes with a zippered pouch on the outside. It also has two side pockets 19" x 7" x 4"; the one on the right comes with dividers and the pocket on the left comes with 4 standard size removable pouches, three large utility pouches and one extra-large utility pouch. Includes two hook and loop straps to hold a D Tank Cylinder. Available in Navy or Red. Washable tarpaulin material also available.

**Premium Red** Item # 10-115-RED-PRE

**Clear Pockets Red** Item # 10-115-RED-CLR

**Tarpaulin Red** Item # 10-115-RED-TPN

**Premium Navy Blue** Item # 10-115-NVY-PRE

\* Tarpaulin Bag  
featured on pg. 11

**Dimensions:** 13" x 16" x 13" | **Shipping:** 20" x 17" x 10" | **Weight:** 10 lbs

**Supply Pack Options:** A, B, C, D, E, F, G, H - See pages 18-22

10-115-RED-CLR

\* Featured On Cover

10-115-NVY-PRE



## RESCUE & TACTICAL BACKPACK

As a part of Kemp USA's Premium line of EMS and Trauma bags, the Rescue and Tactical Backpack is constructed with extremely durable 1680 Denier Nylon, is cross stitched and bar tacked in high wear areas, and has heavy duty, oversized hardware. The main compartment opens completely from top to bottom for easy access to the numerous removable pouches, while MOLLE webbing placed on both the inside and outside can accommodate additional pouches or gear. Two large zippered compartments on the outside of the bag are useful for quick access items. The backpack style shoulder straps are ideal for carrying large amounts of first aid supplies over longer distances. Mesh padded shoulder straps & back area as well as a side and front compression strap system make this bag very comfortable and easy to carry. Additionally, the hip belt helps to distribute weight evenly. The bag has red removable pouches in varying sizes.



Supply Packs available for this bag.



Premium <b>Red</b> Item # 10-122-RED-PRE
Tarpaulin <b>Red</b> Item # 10-122-RED-TPN
Dimensions: 11" x 20" x 14"   Shipping: 18" x 12" x 13"   Weight: 11 lbs
Supply Pack Options: A, B, C, D, E, F - See pages 18-22

## ULTIMATE EMS SUITCASE

The Premium Ultimate Suitcase is offered in the new Premium Blue Line of Bags, by Kemp USA. The carry-on sized suitcase is constructed using 1680 Denier Nylon for maximum durability. High stress points have been reinforced with bartack and cross stitched. The suitcase is equipped with a telescoping handle, a top and side handle for carry, tuck-away padded shoulder straps for backpack carry, double wheels on each side for more floor contact and more control while pulling, and high visibility reflective trim and pull tabs on zippers.

Premium <b>Navy Blue</b> Item # 10-120-NVY-PRE
Dimensions: 15" x 20" x 7"   Shipping: 17" x 21" x 10"   Weight: 9 lbs
Supply Pack Options: A, B, C, D, E, F - See pages 18-22



Medical Supply Packs Available.



## PREMIUM OXYGEN CYLINDER BAG



The Kemp USA Premium Blue Line Oxygen Cylinder Bag is a durable oxygen duffel bag with a side pocket, and it is completely padded inside with closed cell foam. It has two interior straps to secure the tank. This was created to hold and protect a D tank and regulator. It features 8 interior mesh pockets and extended side pocket to hold supplies and accessories. The clamshell design with full zipper gives quick access to the tank. It comes with handheld duffel straps and a removable shoulder strap, both constructed of tough water resistant nylon. If you need to get the tank out in a hurry, the entire inner padded lining is removable.

Premium <b>Navy Blue</b> Item # 10-109-NVY-PRE
Dimensions: 22" x 11" x 9"   Shipping: 13" x 20" x 17"   Weight: 7 lbs



## KEMP USA FLUID RESISTANT LARGE RESPONDER BAG WITH MEDICATION POUCHES

Fluid Resistant Large Responder Bag with 4 removable inside pouches. All pouches have handles for easy transport. This bag also has reflective stripes on the sides and zipper pulls. Extremely durable and all pouches are fluid resistant and can hold medication. Fill this bag with a Medical Supply Pack. (pg.18)

Item # 10-125
Color: Red and black w/ reflective stripes
Dimensions: 16" x 18" x 13"
Shipping: 13" x 20" x 17"   Weight: 7 lbs
Supply Pack Options: A, B, C, D, E, F- See pg. 18-22

## KEMP USA ULTRA EMS BAG

This bag has 8 compartments, extra pockets and strapping, assuring all of your supplies and equipment are secured and organized. Also included is an additional pocket on each end for extra storage. Two removable zippered pouches with transparent windows are attached to the top flap with hook and loop. This bag is made of 600D durable nylon with a reflective yellow stripe all the way around the bag for high visibility at night. The bottom has feet to protect from wear and tear, and it comes with padded nylon duffel handles and an adjustable shoulder strap. Kemp USA now offers supply kits for all EMS bags. The water-resistant nylon is easy to clean.



Item # 10-110-RED
Color: Red   Dimensions: 23" x 12" x 23"
Shipping: 13" x 20" x 14"   Weight: 8 lbs
Supply Pack Options: A, B, C, D, E, F, G, H - See pg. 18-22



## MAXI TRAUMA EMS BAG

The Kemp USA Maxi Trauma Bag is bigger than our first responder bag with more room for a larger assortment of first aid supplies. The padded interior compartment is customizable for fit, regardless of what you're putting in it. This bag is made with 600D nylon. Kemp USA Trauma Bags incorporate the latest technology and design to help you organize your BLS and advanced medical equipment. It comes with an adjustable shoulder strap for easier transport and has elastic loops on the top flap that can accommodate oral airways and small equipment. It has a removable fully adjustable padded center compartment and two large zippered end pockets with bright reflective trim.



Supply Packs are available for this bag.

<b>Navy</b> Item # 10-107-NVY
<b>Orange</b> Item # 10-107-ORG
<b>Red</b> Item # 10-107-RED
<b>Dimensions:</b> 18" x 13" x 10"   <b>Shipping:</b> 18" x 12" x 14"   <b>Weight:</b> 4 lbs
<b>Supply Pack Options:</b> A, B, C, D, E, F - See packs on pages 18-22

## FIRST RESPONDER BAG

The Kemp USA First Responder Bag is geared for the first on the scene. It holds tools, instruments and supplies to treat patients rapidly. Made of a durable nylon material, this kit will stand up to the toughest applications. Numerous pockets and elastic loops to hold a variety of first aid items.



<b>Navy</b> Item # 10-108-NVY
<b>Orange</b> Item # 10-108-ORG
<b>Pink</b> Item # 10-108-PNK
<b>Dimensions:</b> 15" x 10" x 8"
<b>Shipping:</b> 12" x 8" x 8"   <b>Weight:</b> 2 lbs
<b>Supply Pack Options:</b> A, B, C, D, E, F- See pgs.18-22

## GENERAL PURPOSE FIRST AID BAG

The Kemp USA General Purpose First Aid Bag is a great all around bag to carry your medical supplies. This bag has elastic loops to store product on the opening. This bag comes with molded feet on the bottom for extra protection and a shoulder strap. This bag also has a large storage pouch on the outside. It is slightly bigger than the Kemp USA First Responder Bag.



<b>Item #</b> 10-111-ROY
<b>Color:</b> Royal Blue   <b>Dimensions:</b> 14" x 15" x 7"
<b>Shipping:</b> 15" x 21" x 8"   <b>Weight:</b> 5 lbs
<b>Supply Pack Options:</b> A, B, C, D, E, F - See pg. 18-22

## EMS MEDICAL FIELD KIT BAG

The Kemp USA EMS Medical Field Kit Bag is made of durable nylon and comes with four pockets to hold everything you need. We also offer this bag filled with Lifeguard first aid essentials This waist pack is extremely durable and is water resistant. It's very compact and comes with a waistband that expands to 55".



<b>Bag Only</b> Item # 10-113-ROY
<b>Bag with Supply Kit</b> Item# 10-113-ROY-S1
<b>Color:</b> Blue   <b>Dimensions:</b> 13" x 8" x 7"
<b>Shipping:</b> 13" x 11" x 3"   <b>Weight:</b> 2 lbs

## LARGE PROFESSIONAL TRAUMA BAG

Kemp USA's first and most popular bag with the following features: replaceable bottoms, dual-density structural foam and strong 600D nylon construction for the highest quality and longest life. Optimum organization accommodates the most modern supplies used by emergency professionals: a front pocket organized with elastic loops and pouches; an external, easy-access top pocket; and an internal pouch. Includes highly visible reflective pull tabs and trim, all metal black nickel hardware, tuck-away backpack harness, as well as a padded shoulder strap. High stress points have been reinforced with bartack and cross stitched.



<b>Royal Blue</b> Item # 10-104-ROY
<b>Red</b> Item # 10-104-RED
<b>Dimensions:</b> 17.5" x 13" x 10"
<b>Shipping:</b> 18" x 12" x 12"   <b>Weight:</b> 4 lbs
<b>Supply Pack Options:</b> A, B, C, D, E, F - See pg.18-22

**KEMP USA Medical Supply Packs include all the essentials.**

## ULTIMATE EMS BACKPACK

This backpack by Kemp USA has two large frontal pockets that measure 10"x13"x3" and the lower pocket has elastic loops on the inside. The upper pocket comes with a zippered pouch on the outside. On the sides it features two pockets measuring 19"x7"x4". The pocket on the right comes with dividers and the pocket on the left includes 4 standard size removable pouches (as seen in the photo). Upon opening the main compartment of the backpack you will see three large utility pouches and one extra large utility pouch. The lower section of the bag has two hook and loop straps to hold a D tank Cylinder. This bag comes with molded feet on the bottom for extra protection and handles for carrying if desired.



**Get this bag filled and ready to go with our Medical Supply Packs!**

<b>Item #</b> 10-115-RED
<b>Color:</b> Red   <b>Dimensions:</b> 13" x 16" x 13"
<b>Shipping:</b> 20" x 17" x 10"   <b>Weight:</b> 10 lbs
<b>Supply Pack Options:</b> A, B, C, D, E, F, G, H - See pg. 18-22

## KEMP USA PEDIATRIC PACK

The Kemp USA Pediatric Airway Pack is an easy to carry, durable medium sized bag with ample storage. This bag features seven (7) removable, color coordinated zippered pouches (Kelly Green, Orange, Purple, Red, Royal Blue, White and Yellow) with clear windows, and four storage pockets on the outside for easy access to important tools. It also includes a removable adjustable shoulder strap and fixed D-rings for backpack carry. This bag is marked with reflective stripes for easy identification in night time situations.



<b>Item #</b> 10-118-ROY
<b>Color:</b> Blue   <b>Dimensions:</b> 21" x 20" x 11"
<b>Shipping:</b> 13" x 20" x 17"   <b>Weight:</b> 7 lbs



## INTUBATION BAG

The Kemp USA Intubation Bag is designed specifically to help organize supplies required to do a successful intubation in the field. It has enough space to hold ET tubes, a full set of airways and laryngoscope with its blades. This EMS Intubation Bag is equipped with numerous elastic loops in various sizes and lengths for optimal storage and easy organization. The black nylon webbing handles are strong and durable; they have the ability to withstand large forces of pressure. This intubation bag is equipped with two large hook and loop strips on the back to make attaching and transporting the Intubation Bag easy and convenient.



Item # 10-116-ROY	
Color: Blue	Dimensions: 14" x 11" x 3"
Shipping: 13" x 11" x 3"	Weight: 2 lbs

## EMS DRUG POUCH

The Kemp USA drug pouch is a smaller sized EMS bag that is used to hold and secure a large variety of oral and IV medications and tools for basic to advanced medical care. Easy organization and quick access to a variety of all necessary medications. Includes reflective front and back panels along with clear and durable pockets which allow for easy viewing of contents. Interior hook and loop as well as zippers make for optimal organization and quick access to a variety of all necessary medications. This bag is made of durable water-resistant nylon and features highly visible reflective trim.

Item # 10-128	
Color: Red	Dimensions: 10" x 8" x 5"
Shipping: 8.5" x 11" x 6"	Weight: 2 lbs

Top view of bag.



## FIREFIGHTER GEAR BAG

The Kemp USA Firefighter Gear Bag is an over-sized bag designed specifically to hold all of the gear and equipment that a firefighter needs. The Firefighter Gear Bag is made of durable water-resistant nylon for durability and features highly visible reflective trim. The large main compartment is large enough to fit all of your turnout gear, with two large exterior zippered pockets and three exterior pouches to hold additional items such as extra clothes, radios, flashlights, etc. A removable, adjustable carry strap is included for more carrying options. Maltese Cross logo on the front.



Item # 10-123-Red	
Color: Red	Dimensions: 26" x 18" x 33"
Shipping: 15" x 18" x 6"	Weight: 6 lbs

## KEMP USA FIRE & FIRST AID BLANKET

Nylon bag with fast-stick closures for your fire or first aid blanket storage. Highly visible and printed with "Fire First Aid Blanket" for quick identification. Essential for first aid rooms, areas where stretchers are stored and in emergency/rescue vehicles. This blanket bag is easily accessible, lightweight and wall mountable. Blanket sold separately.



Item # 10-127	
Bag with 80% Wool Blanket Item # 10-127-BLA	
Color: Orange	Dimensions: 17" x 12.5" x 4.5"
Shipping: 10" x 3" x 7"	Weight: 1 lb (6 lbs w/ blanket)

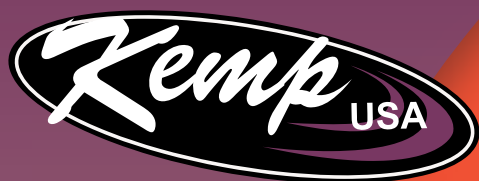

# Medical Supply Packs

Medical Supply Packs are made for Emergency Personnel Bags. They include essential medical supplies and equipment for emergency situations. They can be purchased with a Kemp USA EMS bag or as a separate supply pack. Supply Pack contents vary in quantities or specific first aid instruments and each supply pack has a recommended EMS Bag. See itemized lists on pages 19-22.

## Medical Supply Pack H

See full itemized list on page 22



First Responder Bag  
Item# 10-108-ORG  
filled with Medical  
Supply Pack A.



Large Trauma Bag  
Item# 10-104-RED-PRE  
filled with Medical  
Supply Pack D.



**SUPPLY PACK A** Item # 10-160-A

Recommended EMS Bag: First Responder (10-108)

#	Description	Qty
1	Alcohol Prep Pads	10
2	Ammonia Inhalants	10
3	Bandage, Stretch Gauze Roll 2"	3
4	Bandage, Stretch Gauze Roll 3"	3
5	Bandage, 3" Self-Adherent	1
6	Bandage, Elastic 2" x 5 yd	1
7	Bandage, Elastic 6" x 5 yd	1
8	Bandages, Sheer Plastic Adhesive 1 x 3"	100
9	Bandages, Triangular	1
10	BZK Towelettes	12
11	Combine Pad/Abdominal Pad 5 x 7"	2
12	Combine Pad/Abdominal Pad 8 x 10"	2
13	CPR Mask	1
14	Eye Pad, Oval	2
15	Eye Wash 1 oz	1
16	Finger Splint	1
17	First Aid Book	1
18	First Aid Spray	1
19	Forceps, Kelly Straight	1
20	Gauze Dressing, Petroleum	2
21	Gauze Pads 3" x 3" 8 ply	10
22	Gauze Pads 4" x 4" 8 ply	10
23	Gloves, Nitrile (pair)	2
24	Glucose Gel	1
25	Ice Packs	2
26	Life Saver Hammer	1
27	Mylar Blanket	2
28	Oral Airways 6 pk	1
29	Penlight with Pupil Gauge	1
30	Povidone Iodine Prep Pad	10
31	Safety Pins	2
32	Scissors, Lister Bandage 7.5"	1
33	Shears Utility Black Handle	1
34	Sphygmomanometer/Blood Pressure Cuff	1
35	Stethoscope	1
36	Sting Bite Pads	10
37	Tape, Cloth Surgical 1" x 10 yd	1
38	Tape, Cloth Surgical 2" x 10 yd	1
39	Tape, Waterproof Adhesive 1" x 5 yd	1
40	Trauma Dressing	1
41	Triple Antibiotic Ointment 0.9 g	10
42	Tweezers, Blunt Tip 4"	1
43	Xero Burn Gel 3.5 g packet	2

**SUPPLY PACK B** Item # 10-160-B

Recommended EMS Bag: Maxi Trauma (10-107)

#	Description	Qty
1	Alcohol Prep Pads	10
2	Ammonia Inhalants	10
3	Bandage, Stretch Gauze Roll 2"	3
4	Bandage, Stretch Gauze Roll 3"	3
5	Bandage, Stretch Gauze Roll 4"	3
6	Bandage, 3" Self-Adherent	1
7	Bandage, Elastic 2" x 5 yd	2
8	Bandage, Elastic 6" x 5 yd	1
9	Bandage, Fluff Roll	1
10	Bandages, Sheer Plastic Adhesive 1 x 3"	100
11	Bandages, Triangular	1
12	Burn Sheets 60x90"	1
13	BZK Towelettes	12
14	Combine Pad/Abdominal Pad 5 x 7"	2
15	Combine Pad/Abdominal Pad 8 x 10"	2
16	CPR Mask	1
17	Eye Pad, Oval	4
18	Eye Wash 1 oz	2
19	Finger Splint	1
20	First Aid Book	1
21	First Aid Spray	1
22	Forceps, Kelly Straight	1
23	Gauze Dressing, Petroleum	3
24	Gauze Pads 2" x 2" 8 ply	10
25	Gauze Pads 3" x 3" 8 ply	16
26	Gauze Pads 4" x 4" 8 ply	16
27	Gloves, Nitrile (pair)	3
28	Glucose Gel	1
29	Hot Packs	2
30	Ice Packs	2
31	Life Saver Hammer	1
32	Mylar Blanket	1
33	Oral Airways 6 pk	1
34	Penlight with Pupil Gauge	1
35	Povidone Iodine Prep Pad	10
36	Pulse Oximeter	1
37	Safety Pins	2
38	Scissors, Lister Bandage 7.5"	1
39	Shears Utility Black Handle	1
40	Sphygmomanometer/Blood Pressure Cuff	1
41	Splint Roll 36"	1
42	Stethoscope	1
43	Sting Bite Pads	10
44	Tape, Cloth Surgical 1" x 10 yd	1
45	Tape, Cloth Surgical 2" x 10 yd	1
46	Tape, Waterproof Adhesive 1" x 5 yd	1
47	Tongue Depressor, Sterile	5
48	CAT Tourniquet	1
49	Trauma Dressing	1
50	Triple Antibiotic Ointment 0.9 g	10
51	Tweezers, Blunt Tip 4"	1
52	Xero Burn Gel 3.5 g packet	2

## SUPPLY PACK C Item # 10-160-C

Recommended EMS Bag: Large Responder (10-125)

#	Description	Qty
1	Alcohol Prep Pads	10
2	Ammonia Inhalants	5
3	Bandage, Stretch Gauze Roll 2"	3
4	Bandage, Stretch Gauze Roll 3"	3
5	Bandage, 3" Self-Adherent	1
6	Bandage, Elastic 2" x 5 yd	2
7	Bandage, Elastic 6" x 5 yd	1
8	Bandage, Fluff Roll	1
9	Bandages, Sheer Plastic Adhesive 1 x 3"	100
10	Bandages, Triangular	1
11	Burn Sheets 60x90"	1
12	Burn Spray	1
13	BZK Towelettes	12
14	Combine Pad/Abdominal Pad 5 x 7"	2
15	Combine Pad/Abdominal Pad 8 x 10"	2
16	CPR Mask	1
17	Eye Pad, Oval	2
18	Eye Wash 1 oz	1
19	Finger Splint	1
20	First Aid Book	1
21	First Aid Spray	1
22	Forceps, Kelly Straight	1
23	Gauze Dressing, Petroleum	2
24	Gauze Pads 3" x 3" 8 ply	16
25	Gauze Pads 4" x 4" 8 ply	16
26	Gloves, Nitrile (pair)	3
27	Glucose Gel	2
28	Ice Packs	2
29	Life Saver Hammer	1
30	Mylar Blanket	1
31	Oral Airways 6 pk	1
32	Penlight with Pupil Gauge	1
33	Povidone Iodine Prep Pad	10
34	QuikClot®	1
35	Safety Pins	2
36	Scissors, Lister Bandage 7.5"	1
37	Shears Utility Black Handle	1
38	Sphygmomanometer/Blood Pressure Cuff	1
39	Splint Roll 36"	1
40	Sterile Water for Irrigation 500 ml	1
41	Stethoscope	1
42	Sting Bite Pads	10
43	Tape, Cloth Surgical 1" x 10 yd	1
44	Tape, Cloth Surgical 2" x 10 yd	1
45	Tape, Waterproof Adhesive 1" x 5 yd	1
46	Tongue Depressor, Sterile	5
47	Trauma Dressing	1
48	Triple Antibiotic Ointment 0.9 g	10
49	Tweezers, Blunt Tip 4"	1
50	Xero Burn Gel 3.5 g packet	2

## SUPPLY PACK D Item # 10-160-D

Recommended EMS Bag: Large Trauma (10-104)

#	Description	Qty
1	Alcohol Prep Pads	10
2	Ammonia Inhalants	5
3	Bandage, Stretch Gauze Roll 2"	3
4	Bandage, Stretch Gauze Roll 3"	3
5	Bandage, 3" Self-Adherent	1
6	Bandage, Elastic 2" x 5 yd	2
7	Bandage, Elastic 6" x 5 yd	1
8	Bandage, Fluff Roll	1
9	Bandages, Sheer Plastic Adhesive 1 x 3"	100
10	Bandages, Triangular	1
11	Burn Sheets 60x90"	1
12	Burn Spray	1
13	BZK Towelettes	12
14	Combine Pad/Abdominal Pad 5 x 7"	2
15	Combine Pad/Abdominal Pad 8 x 10"	2
16	CPR Mask	1
17	Eye Pad, Oval	2
18	Eye Wash 1 oz	1
19	Finger Splint	1
20	First Aid Book	1
21	First Aid Spray	1
22	Forceps, Kelly Straight	1
23	Gauze Dressing, Petroleum	2
24	Gauze Pads 3" x 3" 8 ply	16
25	Gauze Pads 4" x 4" 8 ply	16
26	Gloves, Nitrile (pair)	3
27	Glucose Gel	2
28	Ice Packs	2
29	Life Saver Hammer	1
30	Mylar Blanket	1
31	Oral Airways 6 pk	1
32	Penlight with Pupil Gauge	1
33	Povidone Iodine Prep Pad	10
34	QuikClot®	1
35	Safety Pins	2
36	Scissors, Lister Bandage 7.5"	1
37	Shears Utility Black Handle	1
38	Sphygmomanometer/Blood Pressure Cuff	1
39	Splint Roll 36"	1
40	Sterile Water for Irrigation 500 ml	1
41	Stethoscope	1
42	Sting Bite Pads	10
43	Tape, Cloth Surgical 1" x 10 yd	1
44	Tape, Cloth Surgical 2" x 10 yd	1
45	Tape, Waterproof Adhesive 1" x 5 yd	1
46	Tongue Depressor, Sterile	5
47	CAT Tourniquet	1
48	Trauma Dressing	1
49	Triple Antibiotic Ointment 0.9 g	10
50	Tweezers, Blunt Tip 4"	1
51	Xero Burn Gel 3.5 g packet	2

**SUPPLY PACK E Item # 10-160-E**

Recommended EMS Bag: EMS Suitcase (10-120)

#	Description	Qty
1	Alcohol Prep Pads	10
2	Ammonia Inhalants	5
3	Bag Valve Mask, Adult	1
4	Bandage, Stretch Gauze Roll 2"	3
5	Bandage, Stretch Gauze Roll 3"	3
6	Bandage, 3" Self-Adherent	1
7	Bandage, Elastic 2" x 5 yd	2
8	Bandage, Elastic 6" x 5 yd	1
9	Bandage, Fluff Roll	1
10	Bandages, Sheer Plastic Adhesive 1 x 3"	100
11	Bandages, Triangular	1
12	Burn Sheets 60x90"	1
13	Burn Spray	1
14	BZK Towelettes	12
15	Combine Pad/Abdominal Pad 5 x 7"	2
16	Combine Pad/Abdominal Pad 8 x 10"	2
17	CPR Mask	1
18	Eye Pad, Oval	2
19	Eye Wash 1 oz	1
20	Finger Splint	1
21	First Aid Book	1
22	First Aid Spray	1
23	Forceps, Kelly Straight	1
24	Gauze Dressing, Petroleum	2
25	Gauze Pads 3" x 3" 8 ply	16
26	Gauze Pads 4" x 4" 8 ply	16
27	Gloves, Nitrile (pair)	3
28	Glucose Gel	2
29	Ice Packs	2
30	Life Saver Hammer	1
31	Mylar Blanket	1
32	Oral Airways 6 pk	1
33	Penlight with Pupil Gauge	1
34	Povidone Iodine Prep Pad	10
35	QuikClot®	1
36	Safety Pins	2
37	Scissors, Lister Bandage 7.5"	1
38	Shears Utility Black Handle	1
39	Sphygmomanometer/Blood Pressure Cuff	1
40	Splint Roll 36"	1
41	Sterile Water for Irrigation 500 ml	1
42	Stethoscope	1
43	Sting Bite Pads	10
44	Tape, Cloth Surgical 1" x 10 yd	1
45	Tape, Cloth Surgical 2" x 10 yd	1
46	Tape, Waterproof Adhesive 1" x 5 yd	1
47	Tongue Depressor, Sterile	5
48	Trauma Dressing	1
49	Triple Antibiotic Ointment 0.9 g	10
50	Tweezers, Blunt Tip 4"	1
51	Xero Burn Gel 3.5 g packet	2

**SUPPLY PACK F Item # 10-160-F**

Recommended EMS Bag: Rescue & Tactical (10-122)

#	Description	Qty
1	Alcohol Prep Pads	10
2	Ammonia Inhalants	5
3	Bandage, 3" Self-Adherent	2
4	Bandage, Elastic 2" x 5 yd	2
5	Bandage, Elastic 6" x 5 yd	1
6	Bandage, Fluff Roll	1
7	Bandages, Sheer Plastic Adhesive 1 x 3"	100
8	Bandages, Triangular	1
9	Burn Sheets 60x90"	1
10	Burn Spray	1
11	BZK Towelettes	12
12	Combine Pad/Abdominal Pad 5 x 7"	2
13	Combine Pad/Abdominal Pad 8 x 10"	2
14	CPR Mask	1
15	Digital Thermometer	1
16	Eye Pad, Oval	4
17	Eye Wash 1 oz	1
18	First Aid Spray	1
19	Forceps, Kelly Straight	1
20	Gauze Dressing, Petroleum	3
21	Gauze Pads 2" x 2" 8 ply	16
22	Gauze Pads 3" x 3" 8 ply	16
23	Gauze Pads 4" x 4" 8 ply	16
24	Gloves, Nitrile (pair)	3
25	Glucose Gel	2
26	Hot Packs	2
27	Ice Packs	2
28	Life Saver Hammer	1
29	Mylar Blanket	1
30	Oral Airways 6 pk	1
31	Penlight with Pupil Gauge	1
32	Perfit Ace Adjustable C-Collar	1
33	Pulse Oximeter	1
34	QuikClot®	1
35	Safety Pins	2
36	Scissors, Lister Bandage 7.5"	1
37	Shears Utility Black Handle	1
38	Sphygmomanometer/Blood Pressure Cuff	1
39	Splint Roll 36"	1
40	Sterile Water for Irrigation 500 ml	1
41	Stethoscope	1
42	Sting Bite Pads	10
43	Tape, Cloth Surgical 1" x 10 yd	1
44	Tape, Cloth Surgical 2" x 10 yd	1
45	Tape, Waterproof Adhesive 1" x 5 yd	1
46	Tongue Depressor, Sterile	5
47	CAT Tourniquet	1
48	Trauma Dressing	1
49	Triple Antibiotic Ointment 0.9 g	10
50	Tweezers, Blunt Tip 4"	1
51	Vent Chest Seal	1
52	Xero Burn Gel 3.5 g packet	2

## SUPPLY PACK G Item # 10-160-G

Recommended EMS Bag: Ultra EMS Bag (10-110)

#	Description	Qty
1	Alcohol Prep Pads	20
2	Ammonia Inhalants	5
3	Bag Valve Mask, Adult	1
4	Bandage, Stretch Gauze Roll 2"	3
5	Bandage, Stretch Gauze Roll 3"	3
6	Bandage, 3" Self-Adherent	2
7	Bandage, Elastic 2" x 5 yd	2
8	Bandage, Elastic 3" x 5 yd	2
9	Bandage, Elastic 6" x 5 yd	1
10	Bandage, Fluff Roll	1
11	Bandages, Sheer Plastic Adhesive 1 x 3"	100
12	Bandages, Triangular	2
13	Burn Sheets 60x90"	1
14	Burn Spray	1
15	BZK Towelettes	12
16	Combine Pad/Abdominal Pad 5 x 7"	2
17	Combine Pad/Abdominal Pad 8 x 10"	2
18	CPR Mask	1
19	D Cylinder Tank	1
20	Digital Thermometer	1
21	Eye Pad, Oval	5
22	Eye Wash 1 oz	2
23	Face Mask, Surgical	1
24	Finger Splint	1
25	First Aid Book	1
26	First Aid Spray	1
27	Forceps, Kelly Straight	1
28	Gauze Dressing, Petroleum	5
29	Gauze Pads 2" x 2" 8 ply	30
30	Gauze Pads 3" x 3" 8 ply	30
31	Gauze Pads 4" x 4" 8 ply	30
32	Gloves, Nitrile (pair)	5
33	Glucose Gel	1
34	Hot Packs	2
35	Ice Packs	2
36	Life Saver Hammer	1
37	Mylar Blanket	2
38	Nasal Cannulas Tubing	3
39	Oral Airways 6 pk	1
40	Oxygen Regulator	1
41	Penlight with Pupil Gauge	1
42	Perfit Ace Adjustable C-Collar	1
43	Povidone Iodine Prep Pad	10
44	Pulse Oximeter	1
45	QuikClot®	1
46	Safety Pins	2
47	Scissors, Lister Bandage 7.5"	1
48	Shears Utility Black Handle	1
49	Sphygmomanometer/Blood Pressure Cuff	1
50	Splint Roll 36"	1
51	Sterile Water for Irrigation 500 ml	1
52	Stethoscope	1
53	Sting Bite Pads	10
54	Tape, Cloth Surgical 1" x 10 yd	2
55	Tape, Cloth Surgical 2" x 10 yd	1
56	Tape, Waterproof Adhesive 1" x 5 yd	2
57	Tongue Depressor, Sterile	5
58	CAT Tourniquet	1
59	Trauma Dressing	1
60	Triple Antibiotic Ointment 1 oz	1
61	Tweezers, Blunt Tip 4"	1
62	Vent Chest Seal	1
63	Xero Burn Gel 3.5 g packet	5

## SUPPLY PACK H Item # 10-160-H

Recommended EMS Bag: Ultra EMS Backpack (10-115)

#	Description	Qty
1	Alcohol Prep Pads	30
2	Ambu ResCue Pump®	1
3	Ammonia Inhalants	10
4	Bag Valve Mask, Adult	1
5	Bandage, Stretch Gauze Roll 2"	6
6	Bandage, Stretch Gauze Roll 3"	6
7	Bandage, Stretch Gauze Roll 4"	6
8	Bandage, 3" Self-Adherent	2
9	Bandage, Elastic 2" x 5 yd	2
10	Bandage, Elastic 6" x 5 yd	1
11	Bandage, Fluff Roll	2
12	Bandages, Sheer Plastic Adhesive 1 x 3"	100
13	Bandages, Triangular	2
14	Burn Sheets 60x90"	1
15	Burn Spray	1
16	BZK Towelettes	24
17	Combine Pad/Abdominal Pad 5 x 7"	2
18	Combine Pad/Abdominal Pad 8 x 10"	2
19	CPR Mask	1
20	D Cylinder Tank	1
21	Digital Thermometer	1
22	Eye Pad, Oval	10
23	Eye Wash 1 oz	2
24	Face Mask, Surgical	2
25	Finger Splint	1
26	First Aid Book	1
27	First Aid Spray	1
28	Forceps, Kelly Straight	1
29	Gauze Dressing, Petroleum	10
30	Gauze Pads 2" x 2" 8 ply	50
31	Gauze Pads 3" x 3" 8 ply	50
32	Gauze Pads 4" x 4" 8 ply	50
33	Gloves, Nitrile (pair)	10
34	Glucose Gel	2
35	Hot Packs	2
36	Ice Packs	2
37	Life Saver Hammer	1
38	Mylar Blanket	2
39	Nasal Cannulas Tubing	3
40	Oral Airways 6 pk	1
41	Oxygen Regulator	1
42	Penlight with Pupil Gauge	1
43	Perfit Ace Adjustable C-Collar	1
44	Povidone Iodine Prep Pad	20
45	Pulse Oximeter	1
46	QuikClot®	1
47	Safety Pins	2
48	Scissors, Lister Bandage 7.5"	1
49	Shears Utility Black Handle	1
50	Sphygmomanometer/Blood Pressure Cuff	1
51	Splint Roll 36"	1
52	Sterile Water for Irrigation 500 ml	1
53	Stethoscope	1
54	Sting Bite Pads	10
55	Tape, Cloth Surgical 1" x 10 yd	2
56	Tape, Cloth Surgical 2" x 10 yd	1
57	Tape, Waterproof Adhesive 1" x 5 yd	2
58	Tongue Depressor, Sterile	10
59	CAT Tourniquet	1
60	Trauma Dressing	2
61	Triple Antibiotic Ointment 1 oz	1
62	Tweezers, Blunt Tip 4"	1
63	Vent Chest Seal	1
64	Xero Burn Gel 3.5 g packet	5

## BLEEDING CONTROL KIT

Kemp USA's Bleeding Control Kit has all the necessary supplies to aid in putting a stop to life threatening bleeding. This kit includes simple, trouble-free tools that are proven to help to save lives. Designed for the easy use of the public in an emergency situation.

**Contents Include:**

- 2 Individually Packaged Compressed Gauze
- 2 Pairs of Nitrile Gloves
- 1 Israeli Bandage
- 1 CAT Tourniquet
- 1 Kemp USA Mylar Blanket
- 1 Pair of Bandage Scissors

<b>Item # 10-168</b>
<b>Shipping: 12" x 8" x 8"   Weight: 5 lbs</b>



## PERSONAL PROTECTIVE EQUIPMENT KIT

Kemp USA's PPE Kit was designed to assist in providing the essentials needed in today's world to help protect yourself. Perfect for sporting events, meetings and family gatherings. Also useful for schools, healthcare facilities and workers, offices, etc. Compact and Convenient.

**Contents Include:**

- 3 Disposable Blue Face Masks
- 3 Packets of Instant Hand Sanitizer
- 9 Antiseptic Wipes
- 1 Pair of Nitrile Gloves

<b>Item # 10-169</b>
<b>Shipping: 10" x 7" x 3"   Weight: 1 lb</b>



## BLOODBORNE KIT

Mandated by many state agencies and ideal for pool areas or where bloodborne pathogens need to be cleaned. Our bloodborne pathogen kits help you stay compliant with OSHA Bloodborne Pathogens Standard (1910.1030) by safely and effectively cleaning up blood and bodily fluid spills. Can be made with different contents to fit your needs. This kit can be customized with your company logo and information.

<b>Hard Case Item # 10-597</b>
<b>Plastic Bag Item # 10-599</b>
<b>Dimensions: 10" x 3.25" x 5"</b>
<b>Shipping: 10" x 7" x 3"   Weight: 2 lbs</b>



## RESPONSE KIT

This is a convenient Response Kit which includes a CPR Mask with O2 outlet, Paramedic Shears, BZK Antiseptic Towelette, and Gallant Disposable Prep Razor, all in a red pouch labeled RESPONSE KIT. This kit can be customized.

<b>Item # 10-129</b>
<b>Color: Red   Dimensions: 6" x 4" x 3"</b>
<b>Shipping: 9" x 7" x 6"   Weight: 2 lbs</b>



## FIRST AID KITS

Great First Aid kit for small, medium, and large pools and settings. Meets ANSI and OSHA Codes. These First Aid Kits come stocked with all the necessities, such as adhesive strips, tape, first aid cream, gauze, gloves, ice packs, compresses, iodine swabs, eye dressing, etc. Comes in a sturdy white plastic box complete with a living hinge.



10 UNIT  
10-703



24 UNIT  
10-705



36 UNIT  
10-706

See customization options on pg. 27



<b>10 Unit 10 Person (82 pcs)</b> Item # 10-703
Dimensions: 8.5" x 5.75" x 3"
Shipping: 10" x 7" x 3"   Weight: 2 lbs

<b>24 Unit 25 Person (188 pcs)</b> Item # 10-705
Dimensions: 13" x 11" x 3"
Shipping: 14" x 12" x 3"   Weight: 3 lbs

<b>36 Unit 50 Person (257 pcs)</b> Item # 10-706
Dimensions: 14.25" x 10" x 3"
Shipping: 15" x 11" x 3"   Weight: 5 lbs



< 2,000 Sq Ft  
10-710



> 5,000 Sq Ft  
10-712

## STATE OF NJ POOL FIRST AID KITS

This kit is the complete mandated State of NJ First Aid Kit for pools of various sizes. It includes all items required by the NJ Board of Health and is packed in a sturdy plastic box complete with a living hinge.

<b>Pools less than 2,000 SqFt</b> Item # 10-710
Dimensions: 8.5" x 5.75" x 3"
Shipping: 10" x 7" x 3"   Weight: 2 lbs

<b>Pools 2,000 - 5,000 SqFt</b> Item # 10-711
Dimensions: 13" x 11" x 3"
Shipping: 14" x 12" x 3"   Weight: 3 lbs

<b>Pools over 5,000 SqFt</b> Item # 10-712
Dimensions: 14.25" x 10" x 3"
Shipping: 15" x 11" x 3"   Weight: 5 lbs

## PLASTIC BOX WITH GASKET (EMPTY)

This white plastic box is durable and features a living hinge. It has strong closing clasps and has a weather-resistant gasket. The case is mountable and is available in four different sizes.

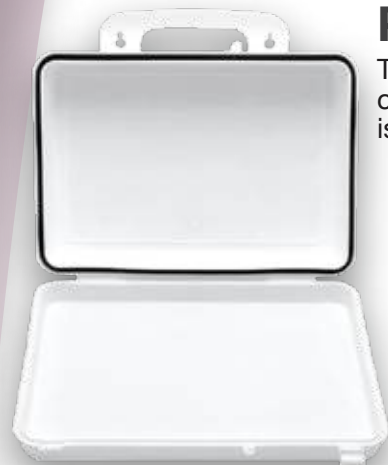

Metal First Aid Cases Also Available

<b>10 Unit</b> Item # 10-714
Dimensions: 8.5" x 5.75" x 3"
Shipping: 10" x 7" x 3"   Weight: 1 lbs

<b>16 Unit</b> Item # 10-717
Dimensions: 9" x 4" x 6"
Shipping: 10" x 7" x 3"   Weight: 1 lbs

<b>24 Unit</b> Item # 10-715
Dimensions: 13" x 11" x 3"
Shipping: 14" x 12" x 3"   Weight: 2 lbs

<b>36 Unit</b> Item # 10-716
Dimensions: 14.25" x 10" x 3"
Shipping: 15" x 11" x 3"   Weight: 2 lbs



**FIRST AID SUPPLIES**

Kemp USA offers a large variety of first aid items. We have great volume pricing with vendors and are able to pass down the savings to our dealers. Please contact us for a quote.

Item #	Description	Case Qty
10-530	KEMP USA NAVY BLUE KNEE PAD	1
10-531	PHILLIPS AED	1
10-532	DISPOSABLE CPR SHIELD	100
10-533	INDIRECT VENT GOGGLES	240
10-534-25	KN95 MASK 25 PACK BOX	25
10-535	BLUE DISPOSABLE FACE MASKS 3-PLY NON-MEDICAL	50
10-536	INFRARED NO TOUCH FOREHEAD THERMOMETER	50
10-537	FULL LENGTH CLEAR PLASTIC FACE SHIELD 5 PACK	180
10-541	SURGICAL FACE MASKS WITH EAR LOOPS & PLASTIC SHIELD	50
10-542	VIROMAX VIRAL & BACTERIAL FILTER	1
10-543	HEPA FILTER FOR BVM OR CPR MASK	1
10-551	VINYL NON-POWDERED GLOVES 50 PAIR PER BOX	10
10-552	NITRILE GLOVES 50 PAIR PER BOX	10



10-531

10-534-25



10-535



10-541



10-542



10-536



10-537



10-533



10-530



\*Brands Subject to Change

10-552

**WE MAKE CUSTOM FIRST AID KITS!**



10-551

## FIRST AID SUPPLIES CONTINUED

**\*Brands Subject to Change**

**\* For First Aid items we can break a full case and sell just the inner packs for a 15% surcharge.**



Item #	Description	Case Qty
11-001	3/4" X 3" PLASTIC BANDAGES (24 boxes of 100 pcs)	2400
11-002	1" X 3" PLASTIC BANDAGES (24 boxes of 100 pcs)	2400
11-003	INSECT BITE SWABS (bulk packaging of 3000 pcs)	3000
11-005	BZK ANTISEPTIC TOWELETTES (10 boxes of 100 pcs)	1000
11-007	TRIANGULAR BANDAGE (bulk packaging)	240
11-008-2	2X2 GAUZE PADS (24 boxes of 100 pcs)	2400
11-008-3	3X3 GAUZE PADS (24 boxes of 100 pcs)	2400
11-008-4	4X4 GAUZE PADS (12 boxes of 100 pcs)	1200
11-011-2	GAUZE BANDAGES SINGLE ROLL 2" X 5 YDS (8 boxes of 12pcs)	96
11-011-3	GAUZE BANDAGES SINGLE ROLL 3" X 5 YDS (8 boxes of 12pcs)	96
11-011-4	GAUZE BANDAGES SINGLE ROLL 4" X 5 YDS (8 boxes of 12pcs)	96
11-012	WATERPROOF TAPE 1/2" X 2 1/2 YDS (bulk packaging of 500 pcs)	500
11-014	BUTTERFLY CLOSURES (24 boxes of 100 pcs)	2400
11-020	ADHESIVE BANDAGES, PLASTIC 2" X 4.5" X-Large (24 boxes of 50 pcs)	1200
11-024	1" X 5 YDS WATERPROOF ADHESIVE TAPE IN CASE	48
11-025-3.5	3.5" ORANGE BANDAGE SHEARS	100
11-025-BLK-7.25	7.5" BLACK BANDAGE SHEARS	1
11-026	4" STAINLESS STEEL TWEEZERS	1
11-028-4OZ	4 OZ LIQUID HAND SANITIZER ( 4 boxes of 24 pieces)	96
11-031	BLUE PE FLUID RESISTANT GOWN (bulk packaging)	100
11-032	PLASTIC JUNIOR BANDAGES 3/8" X 1.5" (36 boxes of 100 pieces)	3600
11-033	FABRIC KNUCKLE BANDAGE 1.5" X 3" (24 boxes of 100 pcs)	2400
11-045-5X9	COMBINE/ABD PADS STERILE 5 X 9 (20 boxes of 20 pcs)	400
11-045-8X10	COMBINE/ABD PADS STERILE 8 X 10 (15 boxes of 24 pcs)	360
11-047-2	ELASTIC BANDAGE WITH SELF CLOSURE 2" X 5 YDS (5 boxes of 10 pcs)	50
11-047-3	ELASTIC BANDAGE WITH SELF CLOSURE 3" X 5 YDS (5 boxes of 10 pcs)	50
11-047-6	ELASTIC BANDAGE WITH SELF CLOSURE 6" X 5 YDS (5 boxes of 10 pcs)	50
11-048	STERILE ALCOHOL PREP PADS (10 boxes of 200 pcs)	2000
11-049	POVIDONE IODINE PREP PAD MEDIUM (10 boxes of 100 pcs)	1000
11-050	TRIPLE ANTIBIOTIC OINTMENT 0.9G FOIL PACKET (12 boxes of 144 pcs)	1728
11-051	NON ADHERENT PAD STERILE 2" X 3" (12 boxes of 100 pcs)	1200
11-052	INSTANT HAND SANITIZER 9 GRAM PACKETS (12 boxes of 144 pcs)	1728
11-053	AMMONIA INHALANTS .33CC (1 BOX 10 PCS)	10
11-151	EMERGENCY BURN GEL 3.5G PACKET (12 boxes of 144 pcs)	1728
11-153	OVAL EYE PAD (bulk packaging of 1000 pcs)	1000
11-154	MULTI TRAUMA DRESSING STERILE 10" X 30" (1 box of 50 pcs)	50
11-155	SPHYGMOMANOMETER ADULT MEDIUM ARM (1 box of 10 pcs)	10
11-156	PETROLEUM GAUZE DRESSING 3" X 9" (4 boxes of 50 pcs)	200
11-157-1	POROUS TAPE 1"X 10 YDS (12 boxes of 12 pcs)	144
11-157-2	POROUS TAPE 2"X 10 YDS (6 boxes of 12 pcs)	72
11-157-3	POROUS TAPE 3"X 10 YDS (4 boxes of 12 pcs)	48

## FIRST AID SUPPLIES CONTINUED

Item #	Description	Case Qty
11-159-DISP	LED DISPOSABLE PENLIGHT (PUPIL GAUGE) (1 box of 6 pcs)	6
11-159-REUSE	LED REUSABLE PENLIGHT (PUPIL GAUGE)	6
11-160	DUAL HEAD STETHOSCOPE	20
11-161	ORAL AIRWAYS 6 PACK	1
11-162	STERILE WATER FOR IRRIGATION 500 ML	18
11-163	SALJET TOPICAL STERILE SALINE 1 OZ/30ML	240
11-164	LISTER BANDAGE SCISSORS, 7 1/2"	1
11-165	KELLY FORCEPS, STRAIGHT, 5 1/2"	1
11-166	4" NON STERILE FLUFF GAUZE BANDAGE ROLL	100
11-167	BURN SHEET 60" X 90" (bulk packaging of 12 pcs)	12
11-168	SELF ADHERENT WRAP 2" X 5 YDS (bulk packaging of 36 pcs)	36
11-174	DISPOSABLE APRON (bulk packaging 1000 pcs)	1000
11-178	COMBAT APPLICATION TOURNIQUET (C_A_T) (sold individually)	1
11-179	SHARP BLUNT SCISSORS 5.5"	1
11-183-FIN	KEMP USA FINGER SPLINT 10 PCS (sold in packs of 10)	1
11-183-ROLL	KEMP USA 36" ROLL SPLINT (sold individually)	50
11-612-SML	ICE PACKS SMALL 4" X 6" (1 box of 50 pcs)	50
11-612-LRG	ICE PACKS LARGE 5" X 9" (1 box of 24 pcs)	24
11-613-SML	HOT PACKS SMALL 4" X 6" (1 box of 50 pcs)	50
11-613-LRG	HOT PACKS LARGE 5" X 9" (1 box of 24 pcs)	24
11-615	KEMP USA HAND SANITIZER DISPENSER (soap sold separately)	6
11-616	KEMP USA HAND SANITIZER FOR DISPENSER	10



## KEMP USA PERSONAL FIRST AID KITS

At Kemp USA, we have the ability to customize any First Aid Kit or Medical Supply Pack. You can mix and match any of our items to meet your specific needs. All of our kit assembly is done in-house here in Charlotte, NC. Contact us today! Below we have four examples of small first aid kits for various situations, needs, and settings.

**NEW - Make your own first aid kit!**

**ALL PURPOSE FIRST AID KIT - 25 ITEMS (160 pcs)**

Adhesive Bandage, Alcohol Wipes, Burn Relief, Butterfly Closures, Antiseptic Towelletes, Gauze Roll, Cotton Applicator, Mylar Blanket, Fabric Bandage, First Aid Guide, Gauze Dressing Pads, Ice Pack, Insect Sting Relief, Junior Bandage, Knuckle Bandage, Nitrile Gloves, Plastic Tweezers, Scissors, Eye Pad, Tongue Depressor, Trauma Pad, Triple Antibiotic Ointment, Waterproof Tape.

**MINI FIRST AID KIT - 16 ITEMS (70 pcs)**

Adhesive Bandage, Alcohol Wipes, Butterfly Closures, Antiseptic Towelletes, Gauze Roll, Mylar Blanket, First Aid Guide, Gauze Dressing Pads, Insect Sting Relief, Fingertip & Knuckle Bandage, Nitrile Gloves, Plastic Tweezers, Scissors, Triple Antibiotic Ointment, Waterproof Tape.

**FAMILY FIRST AID KIT - 24 ITEMS (153 pcs)**

Adhesive Bandage, Alcohol Wipes, Butterfly Closures, CPR One-Way Face Shield, Digital Thermometer, Antiseptic Towelletes, Gauze Roll, Mylar Blanket, Fabric Bandage, First Aid Guide, Gauze Dressing Pads, Hand Sanitizer, Ice Pack, Junior Bandage, Knuckle and Fingertip Bandage, Nitrile Gloves, Plastic Tweezers, Scissors, Eye Pad, Tongue Depressor, Trauma Pad, Triangular Bandages, Triple Antibiotic Ointment, Waterproof Tape.

**PERSONAL FIRST AID KIT - 17 ITEMS (47 pcs)**

Adhesive Bandage, Alcohol Wipes, Butterfly Closures, Antiseptic Towelletes, Gauze Roll, Mylar Blanket, First Aid Guide, Gauze Dressing Pads, Insect Sting Relief, Fingertip & Knuckle Bandage, Nitrile Gloves, Plastic Tweezers, Scissors, Trauma Pad, Triple Antibiotic Ointment, Waterproof Tape.

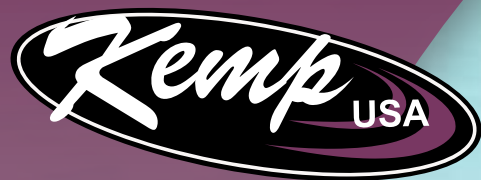

# Patient Immobilization

Kemp USA has an extensive selection of Patient Immobilization items. We carry immobilizers, spineboards, stretchers, straps, extrication devices, and more. The best part is that we have the best inventory supply on hand in the industry, ready to ship.



## KEMP USA HEAD IMMOBILIZER

This Head Immobilizer is easy to use and is compatible with all spineboards on the market, except for EG and TG boards. Our immobilizers feature side blocks with wide fast-stick closures for a snug fit and up to 50% more support surface. The Kemp USA Head Immobilizer has two large circular ear holes to monitor bleeding and fluid drainage. It also comes with 2 head/chin straps and a base plate that adheres easily to the board. The Kemp USA Head Immobilizer has no metal components and can be used during x-rays, MRI and CT scan procedures. It's waterproof and buoyant, so it works great for water rescues. Can easily be cleaned and disinfected for reuse. When purchasing head immobilizers, keep in mind all that head immobilizers are not equal. Constructed of only the highest grade of foam and a unique dipping process, these immobilizers are made to last. Can be made with your logo or in custom colors. Call for minimums and pricing.

### HEAD IMMOBILIZER SET

<b>Black</b>	Item # 10-001-BLK
<b>Orange</b>	Item # 10-001-ORG
<b>Red</b>	Item # 10-001-RED
<b>Royal Blue</b>	Item # 10-001-ROY
<b>Yellow</b>	Item # 10-001-YEL
Dimensions: 7" x 10" x 16"	
Shipping: 6" x 12" x 18"   Weight: 3 lbs	

Pillows  
Item# 10-011

Base  
Item# 10-020

Straps  
Item# 10-004

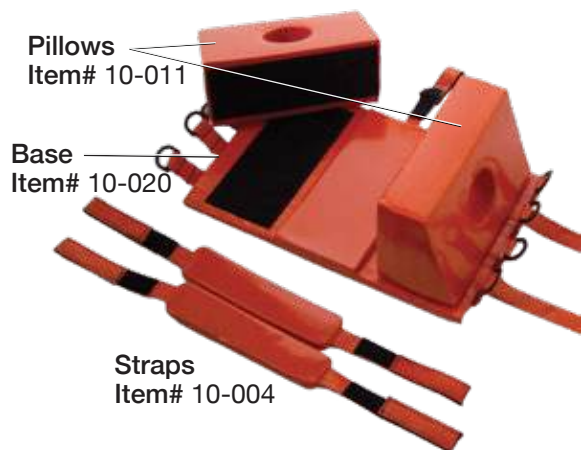

### REPLACEMENT BASE

<b>Orange</b>	Item # 10-020-ORG
<b>Red</b>	Item # 10-020-RED
<b>Royal Blue</b>	Item # 10-020-ROY
<b>Yellow</b>	Item # 10-020-YEL
Dimensions: 16.75" x 10" x 1"	
Shipping: 18" x 12" x 6"   Weight: 2 lbs	

### REPLACEMENT PILLOWS (PAIR)

<b>Orange</b>	Item # 10-011-ORG
<b>Red</b>	Item # 10-011-RED
<b>Royal Blue</b>	Item # 10-011-ROY
<b>Yellow</b>	Item # 10-011-YEL
Dimensions: 6.5" x 5.75" x 9.5"	
Shipping: 10" x 7" x 3"   Weight: 2 lbs	

### REPLACEMENT STRAPS (PAIR)

<b>Orange</b>	Item # 10-004-ORG
<b>Red</b>	Item # 10-004-RED
<b>Royal Blue</b>	Item # 10-004-ROY
<b>Yellow</b>	Item # 10-004-YEL
Dimensions: 10" x 2" x 2.5"	
Shipping: 9.25" x 7" x 3"   Weight: 1 lb	

## PEDIATRIC HEAD IMMOBILIZER

Kemp USA pediatric head immobilizer fits most pediatric spineboards. It comes with two reusable straps for the head and chin to hold the head securely and attaches conveniently to spineboards with hook and loop strapping. Specifically designed with children in mind. Firm support and easy to clean surface. X-Ray translucent and MRI/CT scanning safe.



<b>Complete Set</b> Item # 10-008-ROY	
<b>Head Blocks Only (Pair)</b> Item# 10-006	
<b>Color:</b> Blue	<b>Dimensions:</b> 7" x 10" x 14.75"
<b>Shipping:</b> 6" x 12" x 17"	<b>Weight:</b> 3 lbs

## SCOOP STRETCHER HEAD IMMOBILIZER

The Kemp USA Scoop Stretcher Head Immobilizer is designed for immobilization on scoop stretchers only. This item is a must-have and compatible with all scoop stretchers. Not to be used with the Kemp USA Spineboard, item # 10-993.



<b>Item #</b> 10-010-ORG	
<b>Color:</b> Orange	<b>Dimensions:</b> 16" x 10" x 7"
<b>Shipping:</b> 18" x 12" x 6"	<b>Weight:</b> 3 lbs

## KEMP USA LEG IMMOBILIZER

This piece of equipment is essential for all spineboards and does what common straps cannot. This immobilizer secures the legs with superior comfort to straps by providing padding between the legs and the spineboard. We recommend one with each board purchase. This item is compatible with almost all boards in the industry. Straps sold separately.

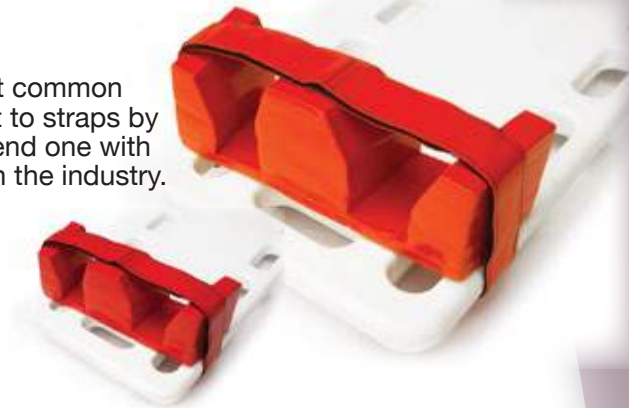

<b>Orange</b>	<b>Item #</b> 10-012-ORG
<b>Red</b>	<b>Item#</b> 10-012-RED
<b>Dimensions:</b> 14.5" x 4.5" x 3.5"	
<b>Shipping:</b> 18" x 12" x 6"	<b>Weight:</b> 2 lbs

## KEMP USA BLOCKS FOR EG AQUATIC BOARD (PAIR)

These head blocks are preferred to other blocks in the industry, extremely durable and will not damage if the board is dropped. Just one pair of blocks will last numerous seasons without needing to be replaced. They are compatible with the Aquatic EG Spine Board (Item # 10-982) or the Wood TG Spine Board (Item # 10-981) and are sold in pairs with the chin strap included.

<b>Item #</b> 10-992	
<b>Color:</b> Black	<b>Dimensions:</b> 6.5" x 6" x 6"
<b>Shipping:</b> 12" x 8.25" x 8.5"	<b>Weight:</b> 3 lbs



Kemp USA Aquatic Board  
Item# 10-982  
See pg. 30

### KEMP USA WOOD TG SPINEBOARD

Kemp USA TG Spineboard is a wooden spine board used by many aquatic facilities. This board is used for extrications or spinal immobilizations and is a standard piece of equipment lifeguards count on. This backboard is made of marine grade okoume plywood with capped hard wood runners and polyurethane bumpers for added protection against wear and tear. Four nylon hook and loop body straps ensure that the victim's body is secured safely and two padded head blocks with hook and loop straps secure the head ensuring patient stabilization.

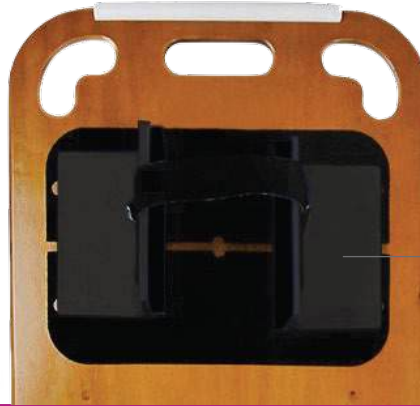

<b>Item # 10-981</b>		
<b>Color:</b> Wood	<b>Dimensions:</b> 78" x 20" x 3"	
<b>Shipping:</b> 80" x 20" x 4"	<b>Weight:</b> 30 lbs	

Equipped with head block system.  
Item listed on bottom of pg. 29

### AQUATIC EG PLASTIC SPINEBOARD KIT

The Kemp USA Aquatic EG Plastic Spineboard comes complete with easy to use hook & loop straps and an extremely durable head block system (Item # 10-992). Buoyancy is customizable by adjusting the polyethylene rods in the back of the spineboard. No metal parts makes the spineboard X-ray translucent.

<b>Item # 10-982</b>		
<b>Color:</b> Orange	<b>Dimensions:</b> 79" x 20" x 1.5"	
<b>Shipping:</b> 79" x 20" x 2.5"	<b>Weight:</b> 26 lbs	



10-982

### ADULT / CHILD SPINEBOARD COMBO

Made of durable polyethylene, this adult/child spineboard combo is a great space saver and decreases stock volume. It is X-ray compatible and its hand grips on all sides makes patient transport easy. Compatible with most head immobilization devices and strap mechanisms. Load capacity: 380 lbs.

<b>Item # 10-984</b>		
<b>Color:</b> Black / Yellow	<b>Dimensions:</b> 72" x 18" x 3"	
<b>Shipping:</b> 73" x 19" x 4"	<b>Weight:</b> 23 lbs	

10-984

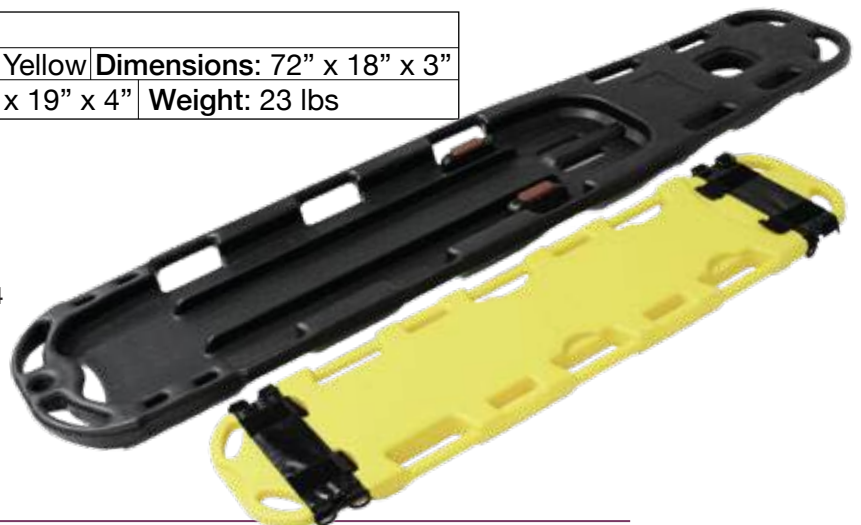

## KEMP USA ADULT 18" SPINEBOARD

The Kemp USA AB Spineboard is an economical yet extremely solid board. Constructed of durable polyethylene and filled with high density foam, it is great for water rescue and has excellent buoyancy. The shell of the board is heavy duty, x-ray translucent and waterproof. This board has 21 handholds and 8 pins for your strapping needs. The weight capacity of this board is 700lbs. Large volume, pallet quantities are available to ship.

<b>Orange</b>	Item # 10-993-ORG
<b>Red</b>	Item # 10-993-RED
<b>Royal Blue</b>	Item # 10-993-ROY
<b>Yellow</b>	Item # 10-993-YEL
<b>White</b>	Item # 10-993-WHI
<b>Dimensions:</b> 17.75" x 72.75" x 2.5"	
<b>Shipping:</b> 19" x 74" x 3"	<b>Weight:</b> 19 lbs

Durable polyethylene  
Large handholds  
Pins for strapping

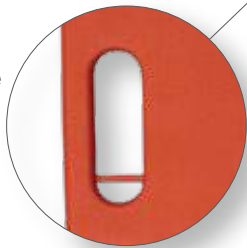

**Mounting Bracket for spineboard storage**  
available on page 36.

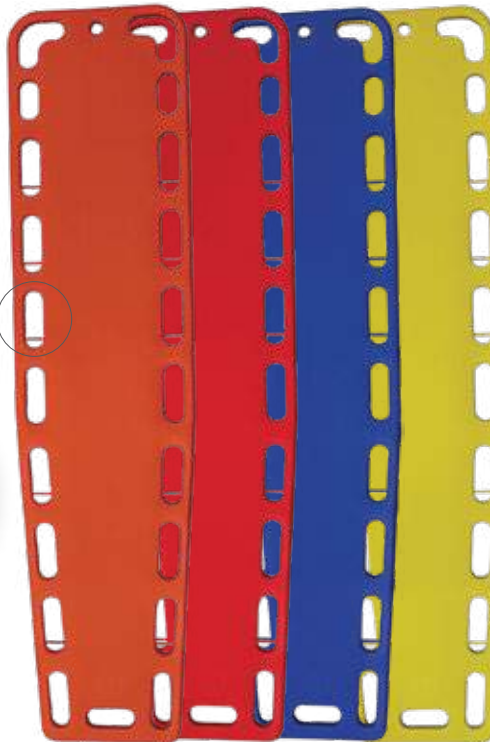

## MCI MASS CASUALTY BOARD - NO FOAM

Manufactured with mass casualty situations in mind, although it can be used in everyday emergency situations as well. Strong, yet economical choice and similar to our Kemp USA AB Spineboard (Item #10-993). It has 10 pins for strapping and 21 large hand holes to make carrying easy.

<b>Blue</b>	Item # 10-998-BLU
<b>Yellow</b>	Item # 10-998-YEL
<b>Dimensions:</b> 18" x 72" x 3"	
<b>Shipping:</b> 19" x 74" x 3"	<b>Weight:</b> 21 lbs

**Not recommended for water usage.**



10-993-WHI

### KEMP USA FOLDING SPINEBOARD

This space-saving Kemp USA Folding Spineboard is ideal for search and rescue. It does not reflect extreme temperatures therefore, the patient is always comfortable. Made of durable high-density polyethylene. Easy to clean and disinfect.

Item # 10-995-ORG			
Color: Orange	Dimensions: 72" x 19.5" x 1.5"		
Shipping: 6.5" x 22" x 39"	Weight: 20 lbs		



### KEMP USA USA PEDIATRIC SPINEBOARD

The Kemp USA Pediatric spine board is 100% X-Ray Translucent. This pediatric spine board is sized specifically for safe, effective transport of children. This item is ideal for youth camps and schools.

Item # 10-996-ORG			
Color: Orange	Dimensions: 43.5" x 14.75" x 2.5"		
Shipping: 54" x 15" x 3"	Weight: 11 lbs		

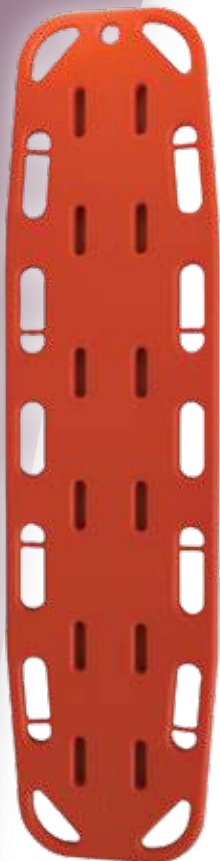

10-996-ORG

### KEMP USA FOLDING POLE STRETCHER

Kemp USA orange folding pole stretcher is a lightweight, more compact alternative to a traditional stretcher. This fold-able stretcher is a versatile option in a wide range of emergency situations. Frequently used for fast and safe patient removal and transport in hospitals, sports fields, gymnasiums, ambulance, and battlefields. Can be folded together both lengthwise and crosswise to fit into minimum storage space. Weight capacity is 350 lbs.

Item # 10-991-ORG			
Color: Orange	Dimensions: 85" x 21" x 6"		
Shipping: 42" x 8" x 4"	Weight: 12 lbs		

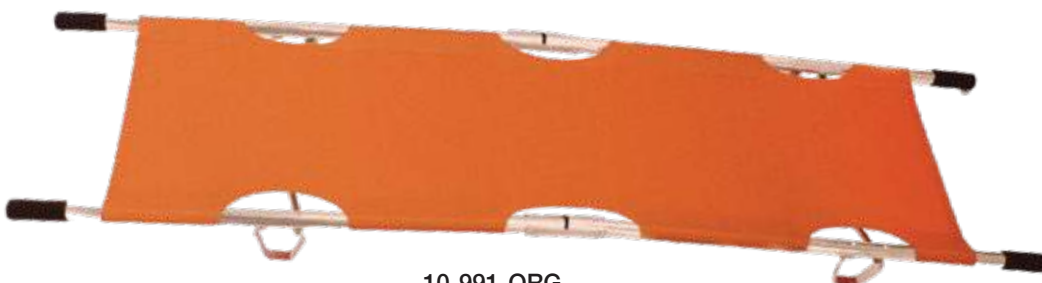

10-991-ORG



## KEMP USA CHAIR STRETCHER

Designed to efficiently transfer patients through cramped areas and on stairs. Complete with three quick-release restraints along with front and rear handles to safely secure and lift the patient, making transport simple and easy. The seat is made of a soft, easy to clean vinyl. Equipped with a wide belt, this chair stretcher can also be easily folded for storage or quickly unfolded for emergency use. Holds up to 350 lbs.

Item # 10-990-ORG	
Color: Orange	Dimensions: 36" x 36" x 20"
Shipping: 39" x 22" x 6.5"	Weight: 23 lbs



## ALUMINUM METAL SCOOP STRETCHER

This Kemp USA Aluminum Metal Scoop Stretcher is used specifically for moving injured people. Design decreases movement to the cervical spine and reduces the risk of additional injuries. Length of the scoop stretcher can be adjusted to the patient's height. Includes patient restraints. Weight capacity is 350 lbs.

Item # 10-989	
Color: Aluminum	Dimensions: 72" 18" x 2.5"
Shipping: 65" x 19" x 3"	Weight: 20 lbs



## KEMP USA YELLOW SCOOP STRETCHER

This Kemp USA Scoop Stretcher is a heavy duty, durable plastic scoop stretcher used specifically for moving injured people. It is most commonly used to lift victims who may have a potential spinal cord injury from the ground, or in order to reduce the chance of undesirable movement of injured areas during the transfer of a patient. Has a structure that separates into two vertical parts that go on either side of the victim. The two parts can then be brought together underneath the patient and then secured using the clips at the top and bottom of the device. Includes patient restraints. Weight capacity is 350 lbs.

Item # 10-988-YEL	
Color: Yellow	Dimensions: 72" 18" x 2.5"
Shipping: 65" x 19" x 3"	Weight: 24 lbs

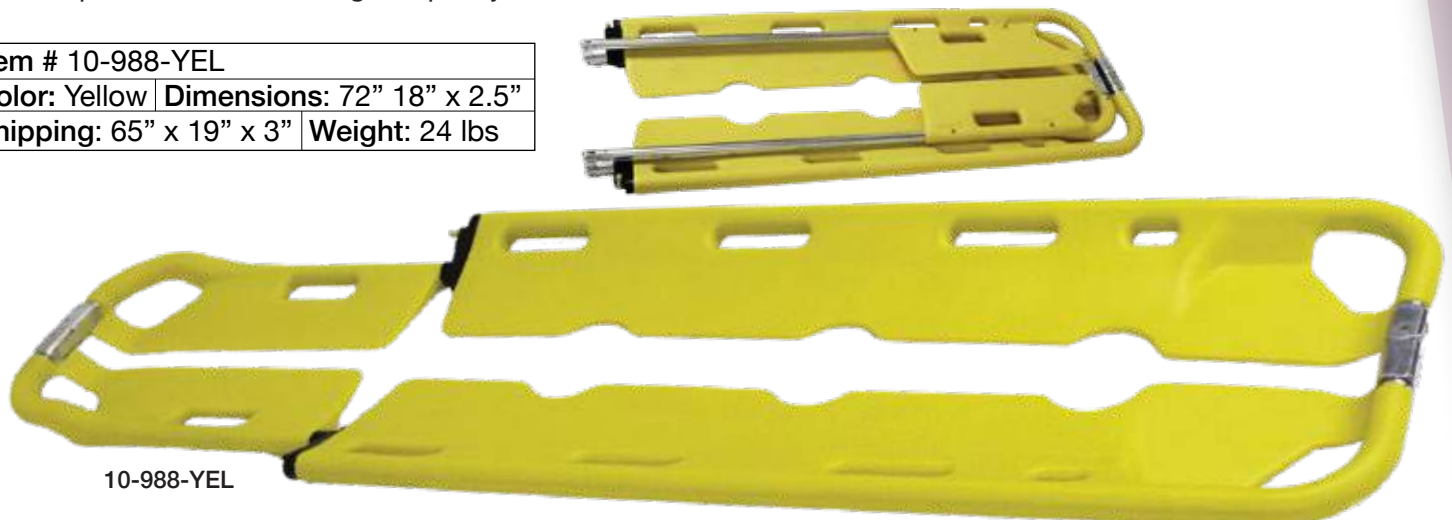

## CAMP MILITARY FOLDING COT WITH CARRYING CASE



The Kemp USA Aluminum Military Folding Cot has an aluminum frame to reduce rust and has X-leg assembly to strengthen the cot and provide stability. Solid structure, good hardness and comfortable use. Space-saving and easy to use. Maximum weight is 250 lbs.

Item # 10-983	
Color: Green	Dimensions: 18" x 74" x 25"
Shipping: 41" x 7" x 9"	Weight: 14 lbs

## PREMIUM PATIENT CARRY SHEET WITH CARRYING CASE

The Kemp USA Patient Carry Sheet is vital in the evacuation of non-ambulant patients from hazardous situations. It allows the patient to be transferred on and off stretchers and is capable of carrying a large person by evenly distributing weight. A great tool for use in confined spaces. Constructed of durable nylon and has a weight capacity of 600 lbs.



Item # 10-986-BLK	
Color: Black	Dimensions: 72" x 38"
Shipping: 6" x 12" x 18"	Weight: 6 lbs

## KEMP USA EXTRICATION DEVICE WITH CARRYING CASE

The Kemp USA extrication device is equipped with two head straps, three torso straps, and two legs straps which accurately and sufficiently secure the victim to the device. This extrication device uses bamboo bars in a nylon jacket, allowing the responders to immobilize the neck and upper spine and safely remove the victim from the vehicle or other confined space. This device does not interfere with anti-shock treatment. If used with proper padding, the device can also successfully immobilize an infant or child. Straps are color coded for ease of use. Set includes wrap-around vest, adjustable neck roll, 2 head straps & carrying case.



Item # 10-987	
Color: Green	Dimensions: 34" x 32.5" x 2.5"
Shipping: 24" x 19" x 7"	Weight: 8 lbs

## ONE PIECE SPINEBOARD STRAP

The Kemp USA one piece spineboard strap is our economical strap. Made of high quality nylon with extremely durable plastic clips. It is used for fast, firm immobilization on all types of spineboards. Can be purchased individually.

Item # 10-301-BLK	
Color: Black	Dimensions: 72" x 2"
Shipping: 9" x 4" x 3"	Weight: 1 lb



## TWO PIECE SPINEBOARD STRAP

The Kemp USA two piece spineboard strap is our most popular strap. Made of high quality nylon with extremely durable plastic clips. This two-piece strap has loop ends to attach itself to the spineboard handles. It's very user friendly and durable with plastic clips.

Item # 10-302-BLK	
Color: Black	Dimensions: 72" x 2"
Shipping: 10" x 7" x 3"	Weight: 1 lb



## TWO PIECE SPINEBOARD STRAP SEAT BELT BUCKLE WITH METAL CLIP ENDS

Kemp's USA two piece spineboard straps are made of strong nylon webbing. They come with a quick-release push button buckle (automobile-type) and metal swivel speed clip. This two-piece strap is far superior to other straps on the market and can only be used with spineboards with pins. Very user friendly.

Item # 10-304-ROY	
Color: Blue	Dimensions: 72" x 2"
Shipping: 7" x 5" x 4"	Weight: 1 lb



## KEMP USA THREE PIECE HOOK & LOOP SPINEBOARD STRAP

This Kemp USA three piece hook & loop spineboard straps are made of durable nylon webbing covered with an easy to remove fast-stick lining, enabling the user to accomplish fast and firm immobilization. This strap is for use with all spineboards. Comes in a set of 3.

Item # 10-305-ORG	
Color: Orange	Dimensions: 72" x 2"
Shipping: 9" x 6" x 3"	Weight: 1 lb



## KEMP USA REFLECTIVE 10-PT STRAPS

The Kemp USA Reflective 10 Point Straps are a favorite among EMS professionals for their functionality. Easy to use single piece straps are made of heavy duty nylon and fasten with hook and loop straps. Comes with a highly visible carrying case for easy storage. The reflective strips along the middle of the straps great for use in dark areas.



Item # 10-307
Color: Black   Dimensions: 16" x 10" x 2.5"
Shipping: 17" x 11" x 3"   Weight: 2 lbs

## COLOR-CODED 10-PT STRAPS

The Kemp USA color-coded 10-pt straps are made of heavy duty nylon and fasten with a hook and loop. A favorite among EMS professionals for their functionality. Color coded for easier use. Holds patient securely and comfortably to spineboard.



10-308

Item # 10-308
Color: Multi   Dimensions: 6" x 19" x 6"
Shipping: 19" x 6" x 6"   Weight: 3 lb

## SPINEBOARD MOUNTING BRACKET

The Kemp USA Spineboard mounting bracket is a great space saver and helps to keep spineboards from falling over in windy conditions. The arms that hold the spineboards are 8" apart, making it universal for all spineboards. Includes mounting hardware for fast and easy installation. Good for indoor or outdoor use.



Item # 10-994
Color: Black   Dimensions: 14.75" x 4" x 2"
Shipping: 15.5" x 3" x 5"   Weight: 3 lbs

## COLLAR BAGS

The Kemp USA Collar Bag conveniently stores your cervical collars. It features two zippers at both ends making it easy to access your collars. Rugged construction with a reflective trim to prevent being left behind at a night scene.



10-102-NVY

<b>Kemp USA Navy</b> Item # 10-102-NVY
<b>Rapid Deployment Orange</b> Item# 10-102-PRO-ORG
Dimensions: 25.5" x 12" x 5.25"
Shipping: 13" x 11" x 3"   Weight: 2 lbs

## PRO-LITE SPEEDBOARD CARRYING CASE

Made with 600D durable nylon with a reflective white stripe all the way around for high visibility at night. The double pull zipper opens up to reveal 2 large interior pockets. The bag can be toted with the comfortable webbing handles.



Item # 10-112-PRO
Color: Blue   Dimensions: 25.4" x 12" x 5.25"
Shipping: 13" x 11" x 3"   Weight: 1 lbs

# Water Rescue

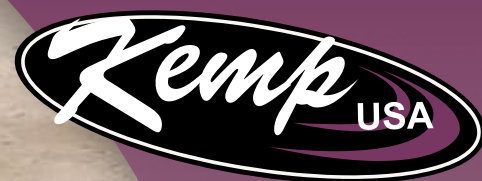

Kemp USA has everything you need to be equipped for water rescue. We have a great selection of Ring Buoys, Rescue Tubes, Rescue Cans, Throw Lines, Life Vests and more. We can fulfill large volume orders to outfit your entire rescue team and quickly ship from our warehouse facility in Charlotte, NC.



## KEMP USA 50" RESCUE TUBE

The 50" tube is the preferred choice of the American Red Cross and the standard rescue tube used by guard training agencies. All Kemp USA Rescue Tubes are made of the highest quality closed cell foam to resist erosion. They are individually hand dipped three times instead of the customary two to ensure proper adhering of the vinyl coating and extend the useful life of the equipment dramatically. Our adjustable shoulder strap and tow line consists of durable nylon webbing and runs through the entire tube. Special pricing for case quantities available.

### 50" RESCUE TUBES

<b>Navy Blue</b>	Item # 10-201-NVY
<b>Orange</b>	Item # 10-201-ORG
<b>Red</b>	Item # 10-201-RED
<b>No Logo Red</b>	Item # 10-201-RED-NL
<b>Yellow</b>	Item # 10-201-YEL
Dimensions: 49.5" x 6" x 3"	
Shipping: 51" x 6" x 6"   Weight: 4 lbs	

### Kemp USA Rescue Tube Construction

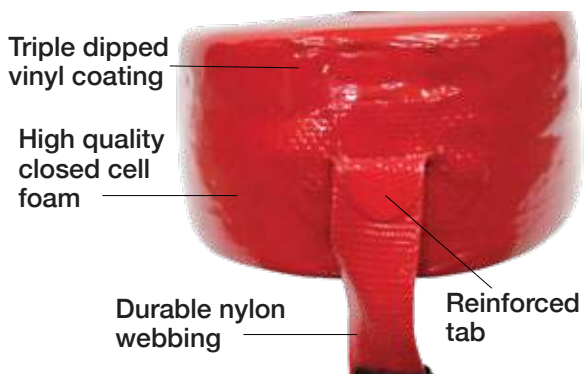

Best for pools, water parks, oceans, and training.

### KEMP USA 40" RESCUE TUBE

We carry a few different tube styles in the 40" size, however only in red. This rescue tube has the same durable quality construction as the 50" rescue tube. The 40" tube is best used for pools or lakefronts. Not recommended for oceans or water parks.



Plastic Clips  
Item# 10-202-RED

Brass Clips  
Item# 10-203-RED

YMCA w/ CPR Mask Holder  
Item# 10-207-YMCA

Brass Clips

Special Pricing  
for Case Quantities!

CPR Mask Holder

<b>Plastic Clips Red</b> Item # 10-202-RED	
<b>Brass Clips Red</b> Item # 10-203-RED	
<b>YMCA CPR Mask Holder</b> Item # 10-207-YMCA	
<b>Guard CPR Mask Holder</b> Item # 10-207-GUARD	
Dimensions: 39.5" x 6" x 3"	
Shipping: 41" x 6" x 6"	Weight: 4 lbs



GUARD w/ CPR Mask Holder  
Item# 10-207-GUARD

### 53" CUT-A-WAY RESCUE TUBE

The cut-a-way rescue tube has unique hand grips to ensure that people with smaller hands can grasp the rescue tube easily. Slightly narrower & longer than our standard rescue tube. Constructed of the same high quality as all of our rescue tubes.



Item # 10-204-RED	
Color: Red	Dimensions: 52.5" x 6" x 3"
Shipping: 51" x 6" x 6"	Weight: 4 lbs

### SPLASH 50" RESCUE TUBES

The 50" tube is the preferred choice of the American Red Cross and the standard rescue tube used by guard training agencies. These Splash Rescue Tubes features a unique design with splashing that adds life to your solid colored rescue tubes. It has all the same features and construction quality as our #10-201-RED. These are typically used as a great incentive for Guards.



<b>Guard Of The Week</b> Item # 10-212	
<b>Navy Blue / White</b>	Item # 10-213-NVY/WHT
<b>Red / Black</b>	Item # 10-213-RED/BLK
<b>Royal Blue / White</b>	Item # 10-213-ROY / WHT
<b>Yellow / Black</b>	Item # 10-213-YEL/BLK
Dimensions: 49.5" x 6" x 3"	
Shipping: 51" x 6" x 6"	Weight: 4 lbs

10-212

## KEMP USA RESCUE TUBE COVERS

This very popular Rescue Tube Cover fits all 40" and 50" rescue tubes. " Extends the life of the tube by protecting it from lifeguard activity. This is a wise investment and should be purchased with every rescue tube ordered.

<b>Orange</b> Item # 10-401-ORG
<b>Red</b> Item # 10-401-RED
<b>Royal Blue</b> Item # 10-401-ROY
<b>Rapid Seal Mask Holder</b> Item # 10-402-RED
<b>Dimensions:</b> 27.75" x 8.75" x 0.5"
<b>Shipping:</b> 10" x 7" x 3"   <b>Weight:</b> 1 lbs

Rapid Seal Mask Storage (see mask on pg. 7)



Red Tube Cover w/ Rapid Seal Mask Holder Item# 10-402-RED



## KEMP USA RESCUE CANS

Produced with thick cross linked polyethylene walls, a heavy duty 2" strap, and 10 feet of 11/32" tow line. Features pebble-grained hand grips to reduce slippage during water rescue. Ideal for open water rescue at beaches. The 28" rescue can supports single-victim rescue. The 34" rescue can supports multi-victim rescue.

<b>28" Rescue Can</b> Item # 10-220
<b>Dimensions:</b> 28" x 10" x 5"
<b>Shipping:</b> 28" x 8" x 8"   <b>Weight:</b> 4 lbs
<b>34" Rescue Can</b> Item # 10-221
<b>Dimensions:</b> 35" x 10" x 5"
<b>Shipping:</b> 35" x 8" x 5"   <b>Weight:</b> 6 lbs



## COAST GUARD APPROVED RING BUOYS

Kemp USA offers USCG Approved buoys in three different sizes; 20", 24", and 30". USCG approval number is 160.050/147/0 and is classified as a PFD type 4. These buoys feature solid closed cell foam throughout and are soft and resilient to the touch. They resist weather and temperature extremes and, most importantly, will not rot or mildew. Bulk quantity discounts and free freight minimums available. Lead time for free freight is 30 days. Available in orange or white.

<b>20" Ring Buoy</b> Item # 10-206
<b>Dimensions:</b> 20" x 20" x 3"
<b>Shipping:</b> 21" x 21" x 5"   <b>Weight:</b> 6 lbs
<b>24" Ring Buoy</b> Item # 10-205
<b>Dimensions:</b> 24" x 24" x 3"
<b>Shipping:</b> 24" x 24" x 4"   <b>Weight:</b> 6 lbs
<b>30" Ring Buoy</b> Item # 10-233
<b>Dimensions:</b> 30" x 30" x 3"
<b>Shipping:</b> 30" x 30" x 4"   <b>Weight:</b> 6 lbs



### LIFESTYLE RING BUOYS

Kemp USA lifestyle ring buoy is a decorative non USCG approved ring buoy. Produced with a polyfoam body, braided polyethylene perimeter rope and blue rope straps. Ideal for residential pools for decorative purposes only. Not recommended as a lifesaving device.

<b>19" Ring Buoy Item # 10-226</b>	
<b>Dimensions:</b> 19" x 19" x 3"	
<b>Shipping:</b> 21" x 21" x 5"	<b>Weight:</b> 2 lbs
<b>24" Ring Buoy Item # 10-227</b>	
<b>Dimensions:</b> 24" x 24" x 3"	
<b>Shipping:</b> 24" x 24" x 4"	<b>Weight:</b> 3 lbs

### RING BUOY J -HOOK MOUNT BRACKET

This Kemp USA aluminum J-Hook mount bracket is a great way to hang Ring Buoys so that they are visible and easily accessible. Also has a hook to hang the throw rope. A must for every ring buoy purchase.

<b>Item # 10-224</b>	
<b>Dimensions:</b> 10" x 9" x 3"	
<b>Shipping:</b> 11" x 10" x 4"	<b>Weight:</b> 2 lbs

### THROW ROPE WITH FLOAT & RING BUOY HOLDER

Kemp USA's Throw Line and Buoy Ball features a heavy duty polypropylene rope and an attached durable foam float. It includes an aluminum ring buoy holder that you can attach to most surfaces to conveniently hold the throw line as well as the Kemp USA Ring Buoy. We recommended the purchase of this product with every ring buoy purchase. This item is mandated by many state codes. Comes in three convenient lengths; 30', 60', and 75'.

<b>Item # 10-222 (30', 60', 75')</b>	
<b>Dimensions:</b> 12.25" x 8.25" x 9"	
<b>Shipping:</b> 12" x 9" x 9"	<b>Weight:</b> 2 lbs

### 60' ECONOMY THROW LINE WITH BALL

Constructed using a strong polypropylene white rope, complete with a floating float. This durable throw line is a reliable and economical option for use with your Kemp USA Ring Buoy. A throw line is a must with every ring buoy purchase. Has brightly visible orange float.

<b>Item # 10-225</b>	
<b>Dimensions:</b> 10" x 7" x 3"	
<b>Shipping:</b> 13" x 8" x 3"	<b>Weight:</b> 1 lb

### THROW BAG WITH ROPE AND WHISTLE

The Kemp USA Throw Bag features red nylon construction for durability and reflective strap for high visibility in the water. The rope is made from braided polypropylene for long-lasting strength. The throw bag is self draining so it stays afloat. This product comes with a Bengal whistle for added safety.

<b>Item # 10-228 (50', 75', 100')</b>	
<b>Dimensions:</b> 13" x 8" x 6"	
<b>Shipping:</b> 12" x 9" x 9"	<b>Weight:</b> 5 lbs

We can customize the rope length.



## THROWABLE FOAM CUSHION

Keep your boat legal and passengers safe with the Kemp USA throwable foam cushion. Convenient webbing straps for easy carry and throwing in emergency situation. Lightweight, flotation foam construction with durable nylon fabric. U.S. Coast Guard approved.

<b>Item #</b> 10-229
<b>Dimensions:</b> 16" x 5" x 4"
<b>Shipping:</b> 17" x 16" x 5"   <b>Weight:</b> 3 lbs



## KEMP USA TYPE II LIFE JACKET

Keep boaters safe with these lightweight and affordable life jackets. Designed for less bulk and greater comfort. This is a basic flotation device. U.S. Coast Guard Approved Type II Life Jacket/Personal Flotation Device (PFD). Bulk Pricing Available.

<b>Adult Oversized Item #</b> 20-001-ADULT-OVR
<b>Adult &gt; 90 lbs Item #</b> 20-001-ADULT
<b>Youth 50-90 lbs Item #</b> 20-001-YOUTH
<b>Child &lt; 50 lbs Item #</b> 20-001-CHILD
<b>Dimensions:</b> 20" x 13" x 4" (Adult)
<b>Shipping:</b> 20" x 20" x 5"   <b>Weight:</b> 3 lbs

4-Pack available with convenient carry case.



## UNIVERSAL LIFE VEST

The Kemp USA Universal Life Vest provides safety and comfort for a wide range of water activities. Adjustable belts and chest strap. 200 denier nylon and 150 denier poly-twill. Lightweight and durable flotation foam and open-sided styling. Available in blue or red.

<b>Adult Oversized Item #</b> 20-002 ADULT-RED-OVR
<b>Adult Item #</b> 20-002-ADULT
<b>Youth Item #</b> 20-002-YOUTH
<b>Child Item #</b> 20-002-CHILD
<b>Infant Item #</b> 20-002-INFANT
<b>Dimensions:</b> 20" x 13" x 4" (Adult)
<b>Shipping:</b> 20" x 20" x 5"   <b>Weight:</b> 3 lbs

Blue or Red Available.

4-Pack available with convenient carry case.



## COMMERCIAL WORK VEST USGC APPROVED

The Kemp USA Commercial Work Vest is a durable, highly visible USCG approved Type V work vest. Opening in back to accommodate most fall harnesses. Adjustable shoulders and sides. Contrasting stitching on belts and straps for more efficient vessel checks.

<b>Item #</b> 20-004
<b>Color:</b> Orange   <b>Dimensions:</b> 40" x 20" x 2.5"
<b>Shipping:</b> 20" x 14" x 5"   <b>Weight:</b> 4 lbs



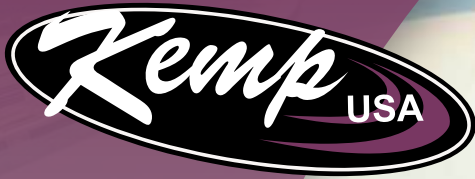

## Guard Gear & Apparel

For over a decade Kemp USA has been supplying and outfitting Lifeguard professionals around the world. From commercial umbrellas to megaphones to first aid hip packs and guard apparel, Kemp USA has a great selection of high quality supplies to keep your teams equipped.



### KEMP USA HIP PACK

Kemp USA carries a variety of Hip Pack styles. The Kemp USA Hip Packs are made to withstand the rigorous use of EMS professionals and Guards in the field. They are made of durable, tear-resistant nylon construction. The hip packs comes with three water-resistant zipper pockets. Includes a heavy duty adjustable 45" waist strap. Available in an assortment of colors and with the GUARD logo or blank with no logo.



<b>Black</b>	Item # 10-103-BLK
<b>Navy Blue</b>	Item # 10-103-NVY
<b>Red</b>	Item # 10-103-RED
<b>Royal Blue</b>	Item # 10-103-ROY
<b>Dimensions:</b> 3" x 7.5" x 5"	
<b>Shipping:</b> 10" x 7" x 3"	<b>Weight:</b> 0.5 lb

Hip packs can be filled and ready to go with our supply packs.

See next pg (43)



## KEMP USA PREMIUM HIP PACK

The Premium Hip Pack is constructed from a 1680 Denier Nylon material for a much more durable hip pack. This hip pack includes over-sized, reflective pull tabs for easy access to all three compartments. Includes a heavy duty adjustable 45" waist strap.



<b>Item # 10-103-RED-PRE</b>	
<b>Color: Red</b>	<b>Dimensions: 3" x 7.5" x 5"</b>
<b>Shipping: 10" x 7" x 3"</b>	<b>Weight: 0.5 lb</b>

## HIP PACK WITH MESH DRAIN

The Kemp USA Hip Pack with Mesh Drain is just like our 10-103 hip pack, but made with mesh drain holes on the bottom of the hip pack for easy drainage and faster drying. It is available in tear-resistant nylon or durable PVC clear plastic. The waist strap adjusts to 45". The hip packs comes with three water-resistant zipper pockets.



<b>Red No Logo Item # 10-124-RED</b>
<b>Clear Guard Logo Item # 10-103-CLR</b>
<b>Dimensions: 3" x 7.5" x 5"</b>
<b>Shipping: 10" x 7" x 3"   Weight: 0.5 lb</b>

## HIP PACK WITH FAST-STICK STRAPS

This is the same great hip pack as our 10-103, but it has the convenient two fast-stick straps at the top to hold a water bottle or towel.

<b>Item # 10-119-RED</b>	
<b>Color: Red</b>	<b>Dimensions: 3" x 7.5" x 5"</b>
<b>Shipping: 10" x 7" x 3"</b>	<b>Weight: 0.5 lb</b>



## KEMP USA SUPPLY PACKS FOR HIP PACKS

These Kemp USA Supply packs are designed to be ordered with our Hip Packs. They are sized just right to conveniently fit inside the hip packs. We can also customize any supply pack.

### PERSONAL PROTECTIVE EQUIPMENT SUPPLY PACK (S3)

**Contents Include:**

- (1) Kemp USA CPR Mask
- (1) Foil Blanket
- (1) Bengal 60 Whistle
- (1) Break-a-way Safety Lanyard
- (1) Pair Nitrile Gloves
- (1) Hand Sanitizer 4 oz
- (1) Face Mask Disposable



### GUARD ESSENTIALS SUPPLY PACK (S2)

**Contents include:**

- (1) Kemp USA CPR Mask
- (1) Foil Blanket
- (1) Bengal 60 Whistle
- (1) Break-a-way Safety Lanyard
- (1) Gloves (pair)



### FIRST AID SUPPLY PACK (S1)

**Contents include:**

- (1) Kemp USA CPR Mask
- (12) BZK Antiseptic Wipes
- (5) Butterfly Bandages
- (4) Sting & Bite Relief Pads
- (1) Triangular Bandage w/Pins
- (10) Adhesive Bandages 3/4"x3"
- (2) Plastic Bandages 2"x4.5"
- (6) Pair Vinyl Gloves
- (4) Gauze Pads 3"x3"
- (1) Gauze Tape Roll
- (1) Instant Ice Pack





## KEMP USA MEGAPHONE

Constructed of tough ABS plastic, the Kemp USA Megaphone is a durable battery-operated megaphone with a siren. Recommended at locations where an emergency can strike or amplified directions need to be given. Available in three different strengths: 6 Watt, 10 Watt, and 25 Watt. Sound can travel 175 yd, 300 yd, and 600 yd respectively. Batteries not included. 6 Watt requires 6x AA, 10 Watt requires 8x AA and 25 Watt, 8x C batteries.

<b>6 Watt, 175 yd</b>	Item # 10-431
<b>Dimensions:</b> 9.5" x 9.5" x 6"	
<b>Shipping:</b> 9" x 12" x 9"	<b>Weight:</b> 3 lbs

<b>10 Watt, 300 yd</b>	Item # 10-432
<b>Dimensions:</b> 13" x 13" x 7"	
<b>Shipping:</b> 9" x 12" x 9"	<b>Weight:</b> 5 lbs

<b>25 Watt, 600 yd</b>	Item # 10-433
<b>Dimensions:</b> 15" x 15" x 9"	
<b>Shipping:</b> 18" x 12" x 10"	<b>Weight:</b> 5 lbs



## KEMP USA 5.5 OZ AIR HORN

This air horn is ideal for coaches, sports officials, camp counselors, lifeguards and referees while also meeting the needs of sports enthusiasts. Features a removable trumpet for easy transport and storage. 100% ozone safe and meets USCG requirements for boating safety.

<b>Item #</b> 10-425
<b>Dimensions:</b> 8.25" x 12.25" x 8.25"
<b>Shipping:</b> 10" x 7" x 3"   <b>Weight:</b> 2 lbs

## KEMP USA 6' UMBRELLAS

The Kemp USA Umbrella is made of durable weather-resistant nylon with a vinyl laminate covering to protect it against the elements. Diameter of the umbrella spans 6 ft. Height is 7 1/2 ft. aluminum pole with push button tilting device. Diameter of umbrella pole is 1 3/8".

<b>Pine Green / White</b>	Item # 12-002-GRN/WHI
<b>Navy Blue / White</b>	Item # 12-002-NVY/WHI
<b>Red / White</b>	Item # 12-002-RED/WHI
<b>Royal Blue / White</b>	Item # 12-002-ROY/WHI
<b>Red with LIFE GUARD</b>	Item # 12-004-RED
<b>Royal Blue with LIFE GUARD</b>	Item # 12-004-ROY
<b>Dimensions:</b> 5" x 5" x 52"	
<b>Shipping:</b> 5" x 5" x 52"	<b>Weight:</b> 9 lbs



12-002



12-004

## KEMP USA WIND UMBRELLA

The Wind Warrior is ideal for windy areas due to the superior venting at the top of the umbrella. This heavy duty, lightweight umbrella features a tilting mechanism, closure strap, and a carry bag. The signature silver top keeps the user cool and shaded by reflecting the sunlight. Diameter of the umbrella spans 67 inches. Height is 7ft. aluminum pole with push button tilting device.

<b>Red Guard</b> Item # 12-003-RED-GRD
<b>Pine Green</b> Item # 12-003-S-PG
<b>Pacific Blue</b> Item # 12-003-S-PB
<b>Dimensions:</b> 4" x 4" x 44"
<b>Shipping:</b> 4" x 4" x 44" <b>Weight:</b> 5 lbs



12-003-RED-GRD



12-003-S-PB

## UMBRELLA STORAGE BAG

Affordable and convenient solution to storing your umbrellas during the winter months. This waterproof vinyl bag prevents mold, keeping your umbrella secure and safe during storage. An essential for all umbrella users

<b>Item #</b> 12-007
<b>Color:</b> Yellow <b>Dimensions:</b> 56" x 9" x 2"
<b>Shipping:</b> 9" x 9" x 3" <b>Weight:</b> 1 lb



## KEMP USA BENGAL 60 WHISTLE

The Bengal 60 whistle is similar to other high dollar pea-less whistles, without the high cost. Designed to be heard above ambient noise, the roar of engines, breaking waves and thundering gale-force winds. The chambers are designed to self-clear when submerged in water. There are no moving parts to freeze, jam or deteriorate. Comes in nine (9) different colors: Black, Green, Orange, Pink, Purple, Red, Royal Blue, Yellow, and Silver.

We can print your logo on the whistle!



<b>Item #</b> 10-426
<b>Dimensions:</b> 2" x 1" x 1"
<b>Shipping:</b> 10" x 7" x 3" <b>Weight:</b> 0.5 lb

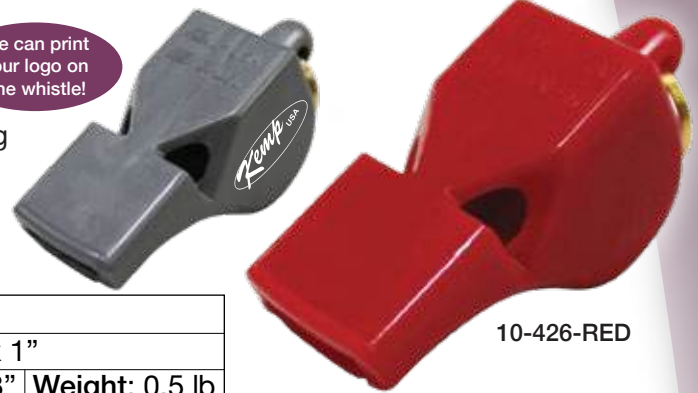

10-426-RED

## FOX 40® WHISTLE

The Fox 40® Classic® is the standard choice referees and coaches at all levels, rescue professionals and general safety worldwide. Flawless, consistent and reliable. The chambers are designed to self-clear when submerged in water. There are no moving parts to freeze, jam or deteriorate.



<b>Item #</b> 10-421
<b>Dimensions:</b> 2" x 1" x 1"
<b>Shipping:</b> 10" x 7" x 3" <b>Weight:</b> 0.5 lb



10-421-BLK



## KEMP USA PEA WHISTLE

This is a high-quality whistle. This whistle has injection-molded plastic whistle similar to Acme 660. This item can only be ordered by the dozen. Available in white or black.

Item # 10-423	
Dimensions: 2" x 1" x 1"	
Shipping: 10" x 7" x 3"	Weight: 0.5 lb



## KEMP USA METAL PEA WHISTLE

This is a brass whistle with nickel plating. Comes with a tapered mouthpiece and similar to the Acme 60 1/2. Manufactured to exacting specifications, with selected natural cork balls, to deliver shrill piercing sound with less effort.

Item # 10-424	
Dimensions: 2" x 1" x 1"	
Shipping: 10" x 7" x 3"	Weight: 0.5 lb



## KEMP USA PREMIUM ROPE LANYARD

This lanyard is the choice of safety patrols and lifeguards worldwide. Made of soft nylon that is 19" long. It is woven to a six warp thickness, which is thicker than a standard lanyard. Comes with swivel J-hooks for easy attachment.



Item # 10-429 (BLK, RED, ROY)	
Dimensions: 20" x 0.5"	
Shipping: 8" x 11" x 1"	Weight: 0.5 lb



## KEMP USA ECONOMY ROPE LANYARD

This lanyard is a great economical choice. Made of soft nylon that is 19" long. Comes with swivel J-hooks for easy attachment. This item can only be ordered by the dozen. Available in Black, Red, or Royal Blue.

Item # 10-429-ECO (BLK, RED, ROY)	
Dimensions: 20" x 0.5"	
Shipping: 8" x 11" x 1"	Weight: 0.5 lb



## KEMP USA BREAK-A-WAY ROPE LANYARD

This Break-a-way Lanyard can help keep the lifeguard out of a dangerous situation during a rescue. Break-a-way feature allows the lanyard to snap off to prevent the guard from choking during water rescue. This lanyard can hold name badges, whistles and keys. This lanyard is extremely popular with lifeguards in water parks.

Item # 10-430 (BLK, RED, ROY)	
Dimensions: 20" x 0.5"	
Shipping: 8" x 11" x 1"	Weight: 0.5 lb

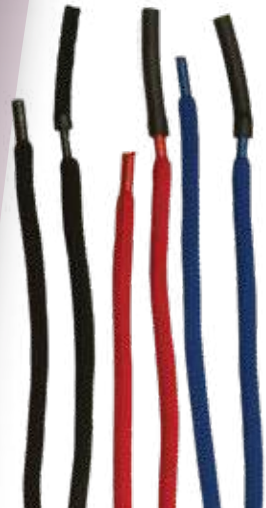
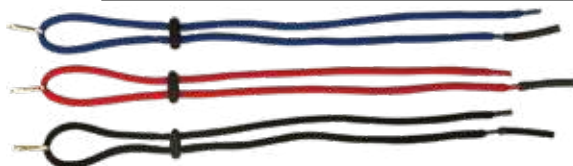

## KEMP USA KEYCHAIN RESCUE TUBE

Great accessory and incentive for guards. This is also an excellent way to promote your company. Keychain floats in water with keys. Available with the Guard logo, or blank. Can also be customized.

<b>Item #</b> 10-210
<b>Dimensions:</b> 4" x 1.25" x 0.75"
<b>Shipping:</b> 8" x 11" x 1"   <b>Weight:</b> 0.5 lb



## KEMP USA LIP MOISTURIZER SPF 15

Kemp USA Lip balm is a Petroleum based lip protectant and moisturizer. This flavorful lip balm is SPF 15. Inscribed with the word "LIFEGUARD." Comes in Cherry Flavor & Bubblegum Flavor.

<b>Item #</b> 10-699
<b>Dimensions:</b> 1" x 0.25" x 0.5"
<b>Shipping:</b> 6" x 9" x 1"   <b>Weight:</b> 0.5 lb

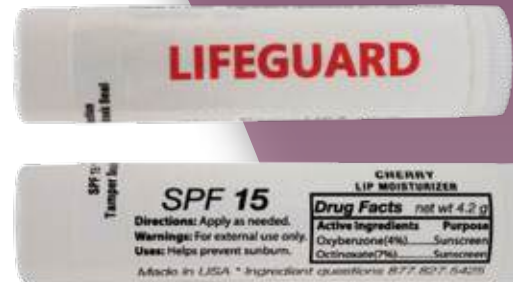

## T-SHIRT WITH GUARD LOGO

The Kemp USA Guard Shirts are 100% cotton for a lifeguard's comfort. Printed GUARD logo on the front and back. This item can also be custom imprinted with your organization's logo in small quantities. Multiple colors and custom logos also available. Shirt sizes are in Small (S), Medium (M), Large (L), Extra Large (XL), Double Extra Large (XXL).

<b>White</b> Item # 18-001 (S,M,L,XL,XXL)
<b>Neon Green</b> Item # 18-006 (S,M,L,XL,XXL)
<b>Dimensions:</b> 30" x 22" (Large)
<b>Shipping:</b> 6" x 9" x 1"   <b>Weight:</b> 1 lb



## TANK TOP WITH GUARD LOGO

The Kemp USA Guard Tank Tops are 100% cotton for a lifeguard's comfort. Printed GUARD logo on the front and back. This item can also be custom imprinted with your organization's logo in small quantities. Multiple color custom logos also available. Available in Small (S), Medium (M), Large (L), Extra Large (XL), Double Extra Large (XXL).

<b>Item #</b> 18-002 (S,M,L,XL,XXL)
<b>Color:</b> White   <b>Dimensions:</b> 30" x 22" (Large)
<b>Shipping:</b> 6" x 9" x 1"   <b>Weight:</b> 1 lb



## SWEAT SHIRT WITH GUARD

The Kemp USA Guard Sweat Shirt is 100% cotton for a lifeguard's comfort. This is an extremely heavy weighted sweatshirt for warmth. Multiple colors and personalization available. We can personalize these and also do other colors. Available in Small (S), Medium (M), Large (L), Extra Large (XL), Double Extra Large (XXL).

<b>Item #</b> 18-007 (S,M,L,XL,XXL)
<b>Color:</b> Red   <b>Dimensions:</b> 30" x 24" (L)
<b>Shipping:</b> 10" x 7" x 3"   <b>Weight:</b> 2 lbs





**LOW PROFILE LIFEGUARD CAP**

The Kemp USA Lifeguard Cap is low-profile, fitted cap with sewn eyelets. It has 6 panels and an adjustable hook and loop strap in back for the perfect fit. Lifeguard and Cross logo embroidered on front. Available in three (3) colors; Navy, Red, and White.



<b>Item # 18-004 (NVY, RED, WHI)</b>	
<b>Dimensions: 5" x 9" x 11"</b>	
<b>Shipping: 6" x 10" x 12"</b>	<b>Weight: 1 lb</b>



**KEMP USA VISOR WITH LIFEGUARD**

Kemp USA Visor has a soft terry cloth lining. Adjustable hook and loop strap on the back to fit all sizes. Lifeguard and Cross logo embroidered on front. Available in three (3) colors; Navy, Red, and White.



<b>Item # 18-005 (NVY, RED, WHI)</b>	
<b>Dimensions: 3" x 9" x 11"</b>	
<b>Shipping: 6" x 10" x 12"</b>	<b>Weight: 1 lb</b>



**Swim & Aquatics**

Kemp USA has its roots in outfitting and supplying high quality products to swim and water recreation entities around the world. We carry a vast variety of items to equip swim teams, water aerobics exercise classes, and water parks.



**KEMP USA RUBBER DIVING BRICK**

This is an inexpensive rescue training tool for guards and emergency rescuers. Great for strength training and rescue training. The rubber diving brick will not harm pool bottom or sides due to its rubber composition. This brick is practically indestructible. These bricks should only be dropped carefully in the pool and should never be thrown.

<b>Item # 10-299</b>	
<b>Dimensions: 8.75" x 3.5" x 3.5"</b>	
<b>Shipping: 10" x 7" x 3"</b>	<b>Weight: 11 lb</b>





## KEMP USA SWIMMING GOGGLES

Kemp USA offers swimming goggles for Adults and Children. The Adult goggles are ideal for performance and competitive swimming. They are equipped with a low-profile design for a sleek look and fit. Featuring a drag-resistant lens for ultimate speed and oversized, curved lens for a wide field of vision. They have a flexible, soft gasket for long lasting comfort. The mirrored coating reduces glare.

The Childrens goggles have a small frame to accommodate various facial types. They are soft and flexible for a comfortable, secure fit. Lenses have UV protection and are Anti-fog. The silicone strap provides premium comfort.

<b>Adult Style 1</b> Item # 18-101
<b>Adult Style 2</b> Item # 18-102
<b>Children Blue / Yellow</b> Item # 18-202-BLUE/YEL
<b>Children Pink / Purple</b> Item # 18-201-PNK/PUR
Shipping: 10" x 7" x 3"   Weight: 0.5 lb



## KEMP USA BUNGEE CORDS

These are great, long-lasting goggle strap replacements, durable, especially in chlorinated water. Resist breaking or stretching and will fit most goggles without slipping. The cord features an easy to adjust toggle to ensure a tight fit. The Bungee cords stand out because of their two-color design. Available in six (6) different color patterns; Black, Royal Blue, Green, Yellow, Red, and Pink.

Item # 14-004 (BLK, ROY, GRN, YEL, RED, PNK)
Dimensions: 21.5" x 0.25" x 0.25"
Shipping: 6" x 9" x 1"   Weight: 1 lb

Bungee Tips



## KEMP USA VINYL BACKSTROKE FLAGS

These Backstroke Flags are made from heavy weight boat-top vinyl. Includes polypro line with an additional 5' at each end for tie off (additional line is available). Please specify pool width when ordering. Flags are sold individually and shipped unassembled. Available in 11 different solid colors; Black, Blue, Green, Maroon, Navy, Orange, Purple, Red, Royal Blue, Yellow, and White.

<b>Backstroke Flags</b> Item # 14-015
<b>Backstroke Flag Hook</b> Item # 14-017
Dimensions: 18" x 12"
Shipping: 18" x 12" x 1"   Weight: 0.5 lb

**\* Please specify pool width when ordering.**



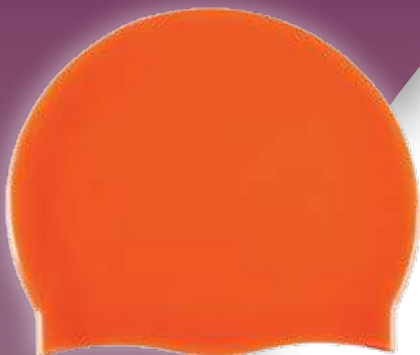

## SILICONE SWIMMING CAP

The Kemp USA Silicone swimming caps are invulnerable to UV rays, making them extremely long lasting and durable. Hydro-dynamically shaped for better fit. May be used for both competitive and recreational use. Nontoxic and non-allergenic. Highly elastic texture. Available in 10 different solid colors.

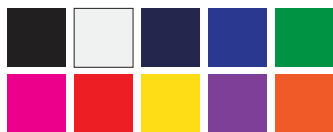

<b>Item # 18-008</b>	
<b>Dimensions: 8" x 7.25"</b>	
<b>Shipping: 6" x 9" x 1"</b>	<b>Weight: 0.5 lb</b>



## KEMP USA KICKBOARDS

Kemp USA Kickboards aids the swimmer in flotation support while helping to improve their kick. Constructed using firm, durable EVA foam they will not chip, break, or absorb water. Highly recommended for swim teams and recreational swimmers. Will withstand long term, repeated use.

14-001



14-011

<b>Large Kickboard Item # 14-001(PUR, RED, ROY, YEL)</b>		
<b>Dimensions: 18.75" x 10.5" x 1.25"</b>		
<b>Shipping: 20" x 11" x 3"</b>	<b>Weight: 1 lb</b>	<b>Case Qty: 20</b>
<b>Small Kickboard Item # 14-011(RED, ROY, YEL)</b>		
<b>Dimensions: 15.25" x 9.75" x 1.25"</b>		
<b>Shipping: 20" x 11" x 3"</b>	<b>Weight: 1 lb</b>	<b>Case Qty: 20</b>
<b>Contour Easy Grip Kickboard Item # 14-007</b>		
<b>Dimensions: 16.5" x 12.5" x 1.5"</b>		
<b>Shipping: 20" x 11" x 3"</b>	<b>Weight: 2 lbs</b>	<b>Case Qty: 20</b>



## KEMP USA PULL BUOYS

Excellent training device for developing endurance and upper body strength. Neutralizes the kicking motion, allowing the swimmer to concentrate on developing proper form and arm stroke technique. Constructed from durable, long lasting EVA foam. Easy to pack due to its small size. Comes in two versions, a solid buoy, and an adjustable buoy for larger body types.



14-002

14-005

<b>Solid Pull Buoy Item # 14-002</b>	
<b>Dimensions: 8.75" x 4.75" x 3.75"</b>	
<b>Shipping: 10" x 7" x 3"</b>	<b>Weight: 1 lb</b>
<b>Adjustable Pull Buoy Item # 14-005</b>	
<b>Dimensions: 8" x 3.75" x 3.75"</b>	
<b>Shipping: 10" x 7" x 3"</b>	<b>Weight: 1 lb</b>



## BACKFLOAT SWIM AID

The Kemp USA Progressive 4-part Back Float Swim Aid is made from soft, comfortable closed cell EVA foam that will not absorb water or chip. Features a split float design that allows adjustment as the swimmer progresses. Easily buckles in the back, freeing arms for proper motion. This swim aid is useful when teaching young children to swim.

<b>Item # 14-014</b>	
<b>Dimensions: 6" x 4" x 5"</b>	
<b>Shipping: 7" x 5" x 6"</b>	<b>Weight: 1 lb</b>

## LEARN 2 SWIM FLOAT BELT FOR CHILDREN

Kemp USA Learn 2 Swim Float Belt for Children makes teaching young children to swim easy. The belt comes with three re-positionable foam blocks that can be removed as the swimmer progresses. Young children can easily buckle the swim float. Must be used with adult supervision.

<b>Item #</b> 14-016
<b>Dimensions:</b> 7" x 6" x 5"
<b>Shipping:</b> 8" x 6" x 5"   <b>Weight:</b> 1 lb



## WATER AEROBIC BELTS

The Kemp USA Water Aerobic Belt is manufactured out of special EVA foam designed to withstand chlorinated water. Reinforced nylon belt attachments with plastic couplings. This belt is specially contoured to fit below the ribcage and above the hips for easy motion and breathing. Provides lumbar support and vertical balance. Available in two (2) different varieties and four (4) different sizes.

<b>Blue Water Aerobic Belt</b> Item # 14-006 (S,M,L)
<b>Dimensions:</b> 7.5" x 1.5" x 22"(S) / 29"(M) / 39"(L)
<b>Shipping:</b> 40" x 8" x 6" (L)   <b>Weight:</b> 2 lbs   <b>Case Qty:</b> 12
<b>Color-Coded Water Aerobic Belt</b> Item # 14-013 (XS,S,M,L)
<b>Dimensions:</b> 1.5" x 23"(XS) / 24"(S) / 25"(M) / 29"(L)
<b>Shipping:</b> 30" x 11" x 3" (L)   <b>Weight:</b> 2 lbs

14-006



Replacement Water Belt Straps Available.



14-013

COLOR-CODED

## KEMP USA AQUATIC DUMBBELLS (PAIR)

These large-diameter dumbbells are great for strengthening your upper body while building endurance. Increases your flexibility while strengthening the muscles in your abdomen, upper back, and upper extremities. Does not absorb water and resistant to chlorine damage.

<b>Item #</b> 14-008
<b>Dimensions:</b> 12" x 6" x 6"
<b>Shipping:</b> 6" x 6" x 25"   <b>Weight:</b> 2 lb



## KEMP USA AQUATIC BAR FLOAT

This bar float is perfect for all kinds of aquatic range-of-motion exercises. Increases your flexibility while strengthening the muscles in your abdomen, upper back, and upper extremities. Does not absorb water and chlorine damage resistant.

<b>Item #</b> 14-009
<b>Dimensions:</b> 6" x 6" x 26"
<b>Shipping:</b> 6" x 6" x 25"   <b>Weight:</b> 2 lb



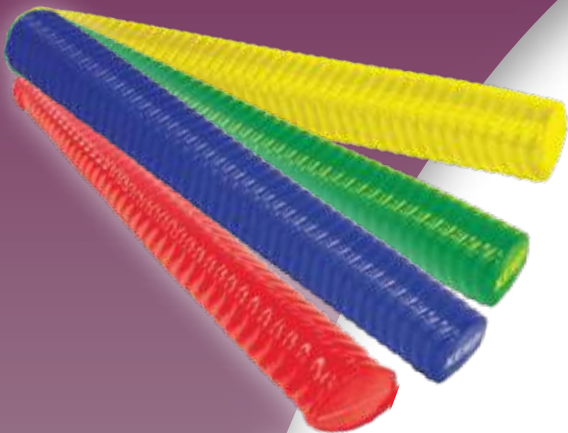

## POOL NOODLE

The flexible foam and ribbed texture are great for extra grip and non-slip. Protected against the sun, pool chemicals and salt water as well as UV resistant therefore, will not deteriorate or crack. Conforms to the body to make floating comfortable. Great for kids and adults, in the pool, river or lake or for exercise. Available in Green, Royal Blue, Red, or Yellow.

<b>Item #</b> 14-019 (GRN, ROY, RED, YEL)
<b>Dimensions:</b> 44" x 6" x 5.5"
<b>Shipping:</b> 45" x 7" x 6.5"   <b>Weight:</b> 5 lbs



14-020

## POOL SADDLE

Kemp USA offers two varieties of pool saddles. They are soft and durable, saddle-shaped floating chair. Frees up your arms and legs for paddling around in the ocean, lake or pool. Made of luxurious foam and is frequently used for water fitness and aquatic therapy.

14-021

<b>Large Saddle</b> Item # 14-020 (RED)
<b>Small Saddle</b> Item# 14-021 (ROY, RED)
<b>Dimensions:</b> 32.5" x 15" (L) / 21" x 20" (S)
<b>Shipping:</b> 33" x 16" x 2"   <b>Weight:</b> 3 lbs



## DELUXE POOL FLOAT

The Kemp USA Deluxe Pool Float is simple, durable, and extremely comfortable. 2 inches thick, delivering outstanding support and buoyancy. Closed-cell foam is lightweight but durable. PVC vinyl coating resists the effects of chlorine, sun and salt water and prevents tears, splits and punctures.

<b>Item #</b> 19-002
<b>Dimensions:</b> 74" x 25" x 2"
<b>Shipping:</b> 28" x 14" x 14"   <b>Weight:</b> 12 lbs

## OVERSIZED FLOATING MAT WATER PAD

This comfortable and flexible floating lily pad is constructed from high-quality, closed cell foam. Complete with built in grommet for anchoring, it is ideal for lounging or floating in the pool, lake, ocean or river. This mat easily rolls and unrolls for hassle-free transportation. The material is mold and mildew resistant so you don't have to worry about clean up after a day on the water. Simply roll it out and enjoy all day, then roll it back up and secure with hook and loop straps for storage. Ships by freight only.

<b>Item #</b> 19-003
<b>Dimensions:</b> 18' x 6' x 1.5"
<b>Shipping:</b> 48" x 40"   <b>Weight:</b> 34 lbs



### COMPACT TRAVEL UMBRELLA

This Kemp USA compact travel umbrella features an automatic opening / self collapsing mechanism. It is a full-sized telescopic handheld umbrella that is compact at 11" when closed and opens with a push of a button. Umbrella features a hand-strap/hang- loop and cover for storage. Extremely durable umbrella. Makes a great gift!

Item # 12-005
Dimensions: 11" x 2" x 5"
Shipping: 10" x 4" x 7"   Weight: 1 lb

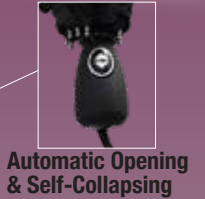

Automatic Opening & Self-Collapsing

### CLASSIC YOGA MAT

The Kemp USA Yoga Mat is latex free with a standard thickness of 4mm. This durable and lightweight EVA foam mat is ideal for on the go or in home use. Dual sided texture gives user a slip free, worry free base. Assists in keeping your muscles and joints comfortable during any pose.

Item # 17-001-ROY
Dimensions: 68" x 24"
Shipping: 25" x 6" x 6"   Weight: 4 lbs



### BACK ROLLER

This Kemp USA Back Roller is a lightweight, textured rolling surface that relieves sore muscles and increases blood flow to massage site. Medium density muscle roller is soft & comfortable to use. Great for a back injury, treating muscle pain, or increasing performance and flexibility. Used and loved by runners, exercise athletes, yoga and pilates students, swimmers, physical or sports therapy patients.

Item # 17-002
Dimensions: 13" x 5.25" x 5.25"
Shipping: 14" x 6" x 6"   Weight: 1 lb



### KEMP USA EMT SHIRT

The Kemp USA EMT Shirts are 100% cotton for comfort. Printed EMT logo on the front and back. This item can also be custom imprinted with your organization's logo in small quantities. Multiple color custom logos also available. Available in Small (S,) Medium (M), Large (L), Extra Large (XL), Double Extra Large (XXL).

Item # 18-001-EMT (S,M,L,XL,XXL)
Dimensions: 13" x 5.25" x 5.25"
Shipping: 14" x 6" x 6"   Weight: 1 lb





## KEMP USA FLAT SHEET

This Kemp USA Flat Sheet is popular among medical and emergency rescue professionals. It comes in two different thread counts; 130 and 180 and is made from 100% cotton. High volume quantities available.

Item # 10-609-130
Item # 10-609-180
Dimensions: 54" x 90"
Shipping: 14" x 10" x 6"   Weight: 1 lb



## HOSPITAL BED FLAT SHEET SET (3PC)

This Kemp USA hospital flat sheet set includes a flat sheet, fitted sheet, and a pillow case. The thread count is 180 and is made from 100% cotton.

Item # 10-610
Dimensions: 39" x 80" x 7"
Shipping: 14" x 10" x 6"   Weight: 2 lbs



## KEMP USA BEACH TOWEL

This beach towel has a blue and white striped design. It is durable and wear-resistant, yet soft and effective to remove moisture from the body. Made of 80% cotton and 20% polyamide.

Item # 10-612
Dimensions: 27.5" x 59"
Shipping: 14" x 6" x 6"   Weight: 1 lb



## KEMP USA GYM TOWEL

These white gym towels are made from 100% cotton, which makes them soft and absorbent. They are popular for hospitals, fitness centers, hotels, spas, pools, and much more. Dimensions are 20 x 40 inches.

Item # 10-613
Dimensions: 20" x 40"
Shipping: 12" x 8" x 6"   Weight: 2 lbs



## KEMP USA BATH TOWEL

These white bath towels are made from 100% cotton, which makes them soft and absorbent. They are popular for hospitals, fitness centers, hotels, spas, pools, and much more. Dimensions are 22 x 44 inches.

Item # 10-614
Dimensions: 22" x 44"
Shipping: 12" x 8" x 6"   Weight: 2 lbs

### KEMP USA HAND SANITIZER DISPENSER

Kemp USA Liquid Soap Dispensers are a must in today's environment. This convenient dispenser comes in a 1000 ml size that can be mounted to the wall with adhesive on the back. Has the option to be mounted with screws. This dispenser is compact and easy to maintain. One handed manual push operation. ADA compliant. Comes without soap. Soap is sold separately and is part # 11-616. The soap comes in packs of 10 (1,000 ml) units each and is 70% Ethyl Alcohol.

<b>Soap Dispenser Item # 11-615</b>
<b>Soap 1000ml, Case Qty 10, Item # 11-616</b>
<b>Dimensions: 5" x 9" x 3.75"</b>
<b>Shipping: 10" x 4" x 7"   Weight: 3 lb</b>



### KEMP USA USCG VINYL COATED FOAM SWIM VEST

The Kemp Vinyl Coated Vest is great for resorts and theme parks. They are United States Coast Guard Approved and made to withstand repetitive use. The vinyl material is easy to clean and durable. The Kemp USA Vinyl Coated Swim Vests come in three (3) sizes; XS, S, and M and three (3) colors; Light Blue, Red, and Yellow.

<b>Item # 20-005 (BLU, RED, YEL)</b>
<b>Dimensions: XS, S, M</b>
<b>Shipping: 20" x 14" x 5"   Weight: 4 lbs</b>

<b>Xtra Small: Fits Chest Size 21"- 23"</b>
<b>Small: Fits Chest Size 23"- 24"</b>
<b>Medium: Fits Chest Size 26"- 29"</b>



### PERSONAL / PROMOTIONAL MINI FIRST AID KIT

This is a great mini first aid kit that can be customized with your company logo. It includes (1) Mylar Blanket, 1 Cold Pack, (10) 1" x 3" Plastic Bandages, (12) BZK Towelettes, and (2) Sting & Bite Relief Pads.

<b>Item # 10-702</b>
<b>Dimensions: 6" x 4" x 3"</b>
<b>Shipping: 9" x 7" x 6"   Weight: 2 lbs</b>



### KEMP USA LUXURY POOL LOUNGER

Made from closed-cell foam that does not absorb water and resists chipping and peeling to ensure long-lasting use. Fade Resistant, this float features a quilted pattern, unique satin finish, and built-in pillow for comfort. Made of NBR Rubber.

<b>Item # 19-001</b>
<b>Dimensions: 72" x 26" x 1.5"</b>
<b>Shipping: 32" x 16" x 16"   Weight: 8 lbs</b>



### KEMP USA BEACH UMBRELLA

The Kemp USA Beach Umbrella is made to withstand the harsh elements at windy beaches. They are constructed of soft but durable nylon. This material resists fading, mildew and is amazingly colorfast. Comes with a two-piece wooden pole. Dimensions are 8' tall and has a 7.5' wide spread. This umbrella is available in different colors upon request. We can also ship blank without "GUARD".

<b>Item # 12-001-RED/GRD</b>
<b>Dimensions: 8' Tall x 7.5' Wide</b>
<b>Shipping: 52" x 6" x 6"   Weight: 9 lbs</b>



## KEMP USA POOL BRUSHES

### 10" ALUMINUM BACK POOL BRUSH WITH STEEL BRISTLES Item# 21-001-10-STL

Kemp USA's Steel bristle brush is our most aggressive brush, for only the most resilient stains. Great for black algae but very tough on the plaster therefore, use only when needed. Not for use on pools with liners.



### 18" CURVED ALUMINUM BACK POOL BRUSH WITH NYLON BRISTLES Item# 21-001-18-NYL

Kemp USA's nylon bristle brush is perfect for walls, tiles and corners. Most common brush for frequent use to remove debris and light algae. This brush is best for pools with liners.



### 18" CURVED ALUMINUM BACK POOL BRUSH WITH STAINLESS STEEL & NYLON BRISTLES Item# 21-001-18-NYL-STL

This combination brush is a mixture of stainless steel and nylon bristles. For occasional use only when you have stubborn algae. Cannot be used on pools with liners.



### 18" ALUMINUM BACK POOL BRUSH WITH STAINLESS STEEL BRISTLES Item# 21-001-STL

Kemp USA's Steel bristle brush is our most aggressive brush, for only the most resilient stains. Great for black algae but very tough on the plaster therefore, use only when needed. Not for use on pools with liners.



## KEMP USA POOL SKIMMERS

### ECONOMY POLYPROPYLENE SKIMMER

- Item# 21-002-ECO ECONOMY POLYPROPYLENE SKIMMER
- Item# 21-002-4-POLE ECONOMY POLYPROPYLENE SKIMMER WITH 4' POLE
- Item# 21-002-5-POLE ECONOMY POLYPROPYLENE SKIMMER WITH 5' POLE

Kemp USA's economical skimmer has a polypropylene frame with a polyester screen used to trap floating particles. This skimmer is also available with a pole.



### KEMP USA HEAVY DUTY SKIMMER WITH ALUMINUM FRAME Item# 21-002-DXE

Kemp USA's deluxe skimmer has an aluminum frame with a strong polyester screen used to trap floating particles.



### KEMP USA HEAVY DUTY DEEP SKIMMER WITH PLASTIC FRAME Item# 21-002-DXE-XL

Kemp USA deep plastic skimmer is great for pools with a lot of leaves. The strong mesh and strong plastic frames helps get pools cleaned quickly. Has a very deep bag. Fits all Kemp USA poles.





## KEMP USA LEAF RAKES

### KEMP USA ECONOMY LEAF RAKE

Item# 21-003-E

Kemp USA's economy leaf rake is made of mesh and specially treated aluminum. Has a very deep bag. Fits all Kemp USA poles.



### KEMP USA HEAVY DUTY LEAF RAKE

Item# 21-003-HD

Kemp USA's heavy duty leaf rake is made of heavy duty mesh and specially treated aluminum. This is professional grade and built to last. Has a very deep bag. Fits all Kemp USA poles. **Weight:** 2 lbs **Dims:** 20"x17"x2"



## KEMP USA POOL VACUUM HEADS

### KEMP USA CONTOUR WEIGHTED SWIMMING POOL VACUUM HEAD

Item# 21-004-CON

The Kemp USA contour vacuum head will help keep your pool free of debris. This features a protective vinyl bumper that will protect the liner of your pool. Fits most standard size 1" poles and fits both 1.25" and 1.5" vacuum hoses. **Weight:** 2 lbs **Dims:** 3.5" x 11" x 6"



### KEMP USA TRIANGULAR POOL WEIGHTED POOL VACUUM HEAD

Item# 21-004-TRI

The Kemp USA contour vacuum head will help keep your pool free of debris. This triangular shape is ideal for cleaning tight corners. Fits most standard size 1" poles and fits both 1.25" and 1.5" vacuum hoses. **Weight:** 3 lbs **Dims:** 12" x 12" x 2"



### KEMP USA FLEXIBLE VACUUM HEAD

Item# 21-004-FLX-ECO

The Kemp USA flexible vacuum head will help keep your pool free of debris. The flexible body curves to the pool floor to keep constant suction on the area your cleaning. Weights keep the vacuum head on the bottom of the pool. The free rolling wheels keep it moving. **Weight:** 4 lbs **Dims:** 14" x 1.5" x 7.5"



### KEMP USA HEAVY DUTY FLEXIBLE VACUUM HEAD PRO 14

Item# 21-004-FLX-PRO-14

The Kemp USA flexible vacuum head will help keep your pool free of debris. The flexible body curves to the pool floor to keep constant suction on the area you're cleaning. Weights keep the vacuum head on the bottom of the pool. This vacuum features swivel handle and ball bearing wheels. **Weight:** 4 lbs **Dims:** 14" x 2" x 10"



### KEMP USA HEAVY DUTY FLEXIBLE VACUUM HEAD PRO 19

Item# 21-004-FLX-PRO-19

This vacuum head is similar to the PRO 14, but has polyurethane wheels and is larger in size. **Weight:** 6 lbs **Dims:** 19" x 2" x 10"



## KEMP USA ALUMINUM POLES

### 2 WAY TELESCOPING POLE 6' to 12'

Item# 21-005-6-12

The Kemp USA telescoping pole easily adjusts from 6' to 12'. Made of blue anodized aluminum pole. Fits all our vacuums, skimmers and rakes. **Weight: 5 lbs Dims: 2" x 6'**

### 3 WAY TELESCOPING POLE 5' to 15'

Item# 21-005-5-15

The Kemp USA telescoping pole easily adjusts from 5' to 15'. Made of blue anodized aluminum pole. Fits all our vacuums, skimmers and rakes. Features inner locking mechanism. **Weight: 10 lbs Dims: 2" x 8'**

### 2 WAY TELESCOPING POLE 8' to 16'

Item# 21-005-8-16

The Kemp USA telescoping pole easily adjusts from 8' to 16'. Made of blue anodized aluminum pole. Fits all our vacuums, skimmers and rakes. **Weight: 5 lbs Dims: 2" x 6'**

## KEMP USA POOL THERMOMETERS

### KEMP USA FLOATING POOL THERMOMETER 1

Item# 23-001-1

Measures pool and spa temperature with accuracy. Has a large temperature display and reads up to 120 Fahrenheit and 50 Celsius. Made of durable and shatter resistant material. Great for all outdoor and indoor pools, spas and hot tubs. **Weight: 0.5 lbs Dims: 8.5" x 2.6" x 2.2"**

### KEMP USA LARGE 10" POOL THERMOMETER 2

Item# 23-001-2

Measures pool and spa temperature with accuracy. Has a large temperature display and reads up to 120 Fahrenheit and 50 Celsius. Made of durable and shatter resistant ABS Plastic material. Great for all outdoor and indoor pools, spas and hot tubs. **Weight: 0.5 lbs Dims: 10" x 2.6" x 2.2"**

## KEMP USA 30' POOL HOSE

Item# 22-001-30

This durable plastic pool vacuum hose is 30' long and fits most vacuums with ease. Made of highly flexible rubber and plastic. Chemical and UV resistant. **Weight: 8 lbs Dims: 30"x1.5" Shipping Dims: 16"x18"x25"**



## DOUBLE HOOK LIFEGUARD SHEPARDS HOOK

Item# 10-218

The Kemp USA Shepards Hook is made of sturdy aluminum and is great for poolside rescue. This is great for the inexperienced rescuers and should be used with the telescoping pole sold separately.



## EZ-LOCK FLOATS

Item# 10-235-BWB-5X9 (BLUE WHITE BLUE)

Item# 10-235-RWR-5X9 (RED WHITE RED)

Item# 10-235-RWB-5X9 (RED WHITE BLUE)

These EZ-LOCK floats sold by Kemp USA are designed to eliminate floats from moving on a rope using no hardware. This innovative float easily attaches to 3/8", 1/2" and 3/4" rope. It is made of linear polyethylene and treated for durability and longevity. Available only in 5x9". Colors: blue/white/blue, red/white/red, red/white/blue.

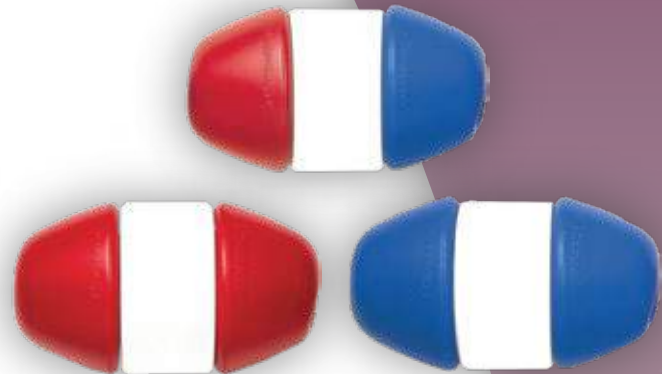

## PREMIUM POLYPROPYLENE ROPE

### ROYAL BLUE/ WHITE ROPE

Item# 10-234-ROY/WHT-3/8 (3/8", 600')

Item# 10-234-ROY/WHT-1/2 (1/2", 600')

Item# 10-234-ROY/WHT-3/4 (3/4", 600')

### YELLOW ROPE

Item# 10-234-YEL-3/8 (3/8", 600')

Item# 10-234-YEL-1/2 (1/2", 600')

Item# 10-234-YEL-3/4 (3/4", 600')



Kemp USA now offers premium grade U.V. stabilized polypropylene floating rope. This rope is rot proof and is available in yellow and blue and white colors. It is a great safety rope. Available in three sizes and can be ordered by the spool or by the foot. Please specify the length of rope needed when ordering.

## KEMP USA MESH RESCUE TUBE

This Kemp USA Mesh Rescue Tube is constructed with a closed cell foam and has a durable nylon mesh casing providing extra longevity and a no-slip grip. It is triple coated with a durable polyurethane.

**50" With Plastic Clips** Item # 10-201-RED-MESH  
**40" With Plastic Clips** Item # 10-202-RED-MESH  
**40" With Brass Clips** Item # 10-203-RED-MESH

Dimensions: 6" x 3"

Shipping: 51" x 6" x 3" | Weight: 3 lb



Item #	Description	Pg #
10-001-BLK	KEMP USA BLACK HEAD IMOBILIZER *****THIS ITEM IS COMPLETELY BLANK*****	28
10-001-ORG	KEMP USA ORANGE HEAD IMMOBILIZER *****THIS ITEM IS COMPLETELY BLANK*****	28
10-001-RED	KEMP USA RED HEAD IMMOBILIZER *****THIS ITEM IS COMPLETELY BLANK*****	28
10-001-ROY	KEMP USA ROYAL BLUE HEAD IMMOBILIZER*****THIS ITEM IS COMPLETELY BLANK*****	28
10-001-YEL	KEMP USA YELLOW HEAD IMMOBILIZER*****THIS ITEM IS COMPLETELY BLANK*****	28
10-004-ORG	KEMP USA ORANGE HEAD IMMOBILIZER REPLACEMENT STRAPS (PAIR)	28
10-004-RED	KEMP USA RED HEAD IMMOBILIZER REPLACEMENT STRAPS (PAIR)	28
10-004-ROY	KEMP USA ROYAL BLUE HEAD IMMOBILIZER REPLACEMENT STRAPS(PAIR)	28
10-004-YEL	KEMP USA YELLOW HEAD IMMOBILIZER REPLACEMENT STRAPS (PAIR)	28
10-006	KEMP USA BLUE PEDIATRIC HEAD IMMOBILIZER BLOCKS	29
10-008-ROY	KEMP USA ROYAL BLUE PEDIATRIC IMMOBILIZER	29
10-011-ORG	KEMP USA ORANGE REPLACEMENT PILLOWS FOR HEAD IMMOBILIZER (PAIR)	28
10-011-RED	KEMP USA RED REPLACEMENT PILLOWS FOR HEAD IMMOBILIZER (PAIR)..	28
10-011-ROY	KEMP USA ROYAL BLUE PILLOWS FOR HEAD IMMOBILIZER (PAIR)..	28
10-011-YEL	KEMP USA YELLOW REPLACEMENT PILLOWS FOR HEAD IMMOBILIZER (PAIR)	28
10-012-ORG	KEMP USA ORANGE LEG IMMOBILIZER	29
10-012-RED	KEMP USA RED LEG IMMOBILIZER	29
10-020-ORG	KEMP USA ORANGE HEAD IMMOBILIZER BASE	28
10-020-RED	KEMP USA RED HEAD IMMOBILIZER BASE	28
10-020-ROY	KEMP USA ROYAL BLUE HEAD IMMOBILIZER BASE	28
10-020-YEL	KEMP USA YELLOW HEAD IMMOBILIZER BASE	28
10-102-NVY	KEMP USA NAVY COLLAR BAG W/ REFLECTIVE TAPE	36
10-102-PRO-ORG	PROLITE RAPID DEPLOYMENT COLLAR BAG	36
10-103-BLK	KEMP USA BLACK HIP PACK WITH WHITE GUARD LOGO	42
10-103-BLK-NL	KEMP USA BLACK HIP PACK*****THIS ITEM IS COMPLETELY BLANK*****	42
10-103-CLR-MSH	KEMP USA CLEAR GUARD HIP PACK WITH MESH BOTOM	42
10-103-NVY	KEMP USA NAVY HIP PACK WITH WHITE GUARD LOGO	42
10-103-NVY-NL	KEMP USA NAVY HIP PACK *****THIS ITEM IS COMPLETELY BLANK*****	42
10-103-RED	KEMP USA RED HIP PACK W/ GUARD LOGO	42
10-103-RED-NL	KEMP USA RED HIP PACK W/ NO LOGO*****THIS ITEM IS COMPLETELY BLANK*****..	43
10-103-RED-PRE	KEMP USA PREMIUM RED HIP PACK	42
10-103-ROY	KEMP USA ROYAL HIP PACK ROYAL W/ GUARD LOGO	42
10-103-ROY-NL	KEMP USA ROYAL HIP PACK *****THIS ITEM IS COMPLETELY BLANK*****	43
10-103-S1	KEMP USA FIRST AID STUFFED HIP PACK	43
10-103-S2	KEMP USA LIFEGUARD ESSENTIALS STUFFED HIP PACK	43
10-103-S3	KEMP USA LIFEGUARD PPE STUFFED HIP PACK	43
10-104-RED	KEMP USA RED LARGE PROFESSIONAL TRAUMA BAG	16
10-104-ROY	KEMP USA ROYAL BLUE LARGE PROFESSIONAL TRAUMA BAG	16
10-104-NVY-PRE	KEMP USA PREMIUM BLUE LARGE TRAUMA BAG	10,12
10-104-RED-PRE	KEMP USA PREMIUM RED LARGE TRAUMA BAG	12
10-104-RED-TPN	KEMP USA RED TARPULIN FLUID-RESISTANT LARGE TRAUMA BAG	12
10-107-NVY	KEMP USA NAVY MAXI TRAUMA BAG	15
10-107-ORG	KEMP USA ORANGE MAXI TRAUMA BAG	15
10-108-NVY	KEMP USA NAVY FIRST RESPONDER BAG	15
10-108-ORG	KEMP USA ORANGE FIRST RESPONDER BAG	15
10-108-PNK	KEMP USA PINK FIRST RESPONDER BAG	15
10-109-NVY-PRE	KEMP USA PREMIUM BLUE OXYGEN BAG	14
10-110-RED	KEMP USA RED ULTRA EMS BAG	14
10-111-ROY	KEMP USA ROYAL BLUE GENERAL PURPOSE FIRST AID BAG	15
10-113-ROY	KEMP USA ROYAL BLUE EMS MEDICAL FIELD KIT BAG	15
10-113-ROY-S1	KEMP USA GUARD STATION STUFFED MEDICAL FIELD KIT	15
10-115-NVY-PRE	KEMP USA PREMIUM BLUE LINE ULTIMATE EMS BACKPACK	16
10-115-RED	KEMP USA RED ULTIMATE EMS BACKPACK	12
10-115-RED-CLR	KEMP USA RED ULTIMATE EMS BACKPACK WITH CLEAR SIDES	12
10-115-RED-PRE	KEMP USA PREMIUM RED LINE ULTIMATE EMS BACKPACK	12
10-115-RED-TPN	KEMP USA TARPULIN RED FLUID-RESISTANT ULTIMATE EMS BACKPACK	12
10-116-ROY	KEMP USA ROYAL INTUBATION BAG	17
10-118-ROY	KEMP USA ROYAL PEDIATRIC PACK	16
10-119-RED	KEMP USA RED HIP PACK WITH LOOPS TO HOLD TOWEL	43
10-120-NVY-PRE	KEMP USA PREMIUM BLUE LINE EMS SUITCASE	11,13
10-122-RED-PRE	KEMP USA PREMIUM RED RESCUE AND TACTICAL BAG	11,13
10-122-RED-TPN	KEMP USA TARPULIN RED FLUID-RESISTANT RESCUE AND TACTICAL EMS BAG	11,13
10-123-RED	KEMP USA RED FIREFIGHTER GEAR BAG	17
10-124-RED	KEMP USA RED WATER DRAINING MESH HIPPACK	43
10-125	KEMP USA RED TARPULIN FLUID-RESISTANT LARGE RESPONDER BAG WITH MEDICATION POUCH	11,14
10-127	KEMP FIRE FIRST AID BLANKET BAG	17
10-127-BLA	KEMP FIRE FIRST AID BLANKET BAG WITH 80% WOOL FIRST AID BLANKET	17
10-128	KEMP EMS DRUG POUCH	17
10-129	KEMP USA RESPONSE KIT	23

Item #	Description	Pg #
10-160-A	MEDICAL SUPPLY PACK A	19
10-160-B	MEDICAL SUPPLY PACK B	19
10-160-C	MEDICAL SUPPLY PACK C	20
10-160-D	MEDICAL SUPPLY PACK D	20
10-160-E	MEDICAL SUPPLY PACK E	21
10-160-F	MEDICAL SUPPLY PACK F	21
10-160-G	MEDICAL SUPPLY PACK G	22
10-160-H	MEDICAL SUPPLY PACK H	22
10-168	BLEEDING CONTROL KIT	23
10-169	PERSONAL PPE KIT - 5 PACK	23
10-201-NVY	KEMP USA NAVY BLUE 50" RESCUE TUBE WITH GUARD IN WHITE	37
10-201-ORG	KEMP USA ORANGE 50" RESCUE TUBE WITH GUARD IN WHITE	37
10-201-RED	KEMP USA RED 50" RESCUE TUBE WITH GUARD LOGO IN WHITE	37
10-201-RED-NL	KEMP USA RED 50" RESCUE TUBE BLANK-NO GUARD LOGO	37
10-201-YEL	KEMP USA YELLOW 50" RESCUE TUBE WITH GUARD LOGO IN BLACK	37
10-202-RED	KEMP USA RED 40" RESCUE TUBE WITH PLASTIC CLIPS & GUARD LOGO IN WHITE	38
10-203-RED	KEMP USA RED 40" RESCUE TUBE WITH GUARD LOGO AND BRASS CLIPS	38
10-204-RED	KEMP USA RED 53" CUT-A-WAY RESCUE TUBE RED W/ GUARD LOGO IN WHITE	38
10-205-OR	KEMP USA ORANGE 24" RING BUOY USCG APPROVED	39
10-205-WHI	KEMP USA WHITE 24" RING BUOY USCG APPROVED	39
10-206-ORG	KEMP USA ORANGE 20" RING BUOY USCG APPROVED	39
10-206-WHI	KEMP USA WHITE 20" RING BUOY USCG APPROVED	39
10-207-RED-GUARD	KEMP USA RED 40" RESCUE TUBE WITH CPR MASK HOLDER	38
10-207-RED-YMCA	KEMP USA RED 40" RESCUE TUBE YMCA	38
10-210	KEMP USA RED RESCUE KEYCHAIN	47
10-212	KEMP USA GUARD OF THE WEEK 50" RESCUE TUBE ROYAL BLUE WITH WHITE SPLASH	38
10-213-NVY/WHI	KEMP USA SPLASH NAVY/WHT 50" RESCUE TUBE	38
10-213-RED/BLK	KEMP USA SPLASH RED/ BLK 50" RESCUE TUBE ..	38
10-213-ROY/WHI	KEMP USA SPLASH ROY/ WHT 50" RESCUE TUBE..	38
10-213-YEL/BLK	KEMP USA SPLASH YEL/ BLK 50" RESCUE TUBE	38
10-218	KEMP USA DOUBLE HOOK LIFEGUARD SHEPARDS HOOK	59
10-220	KEMP USA ORANGE 28" RESCUE CAN	39
10-221	KEMP USA ORANGE 34" RESCUE CAN	39
10-222-30	KEMP USA 30' THROW ROPE WITH FLOAT AND RING BUOY HOLDER	40
10-222-60	KEMP USA 60' THROW ROPE WITH FLOAT AND RING BUOY HOLDER	40
10-222-75	KEMP USA 75' THROW ROPE WITH FLOAT AND RING BUOY HOLDER	40
10-224	KEMP USA RING BUOY J -HOOK MOUNT BRACKET	40
10-225	KEMP USA 60' ECONOMY THROW LINE W/ BALL	40
10-226	KEMP USA 19" LIFESTYLE RING BUOY	40
10-227	KEMP USA 24" LIFESTYLE RING BUOY	40
10-228-100	KEMP USA RED THROW BAG WITH 100' YELLOW ROPE WITH KEMP BENGAL SAFETY WHISTLE	40
10-228-50	KEMP USA RED THROW BAG WITH 50' YELLOW ROPE WITH KEMP BENGAL SAFETY WHISTLE	40
10-228-75	KEMP USA RED THROW BAG WITH 75' YELLOW ROPE WITH KEMP BENGAL SAFETY WHISTLE	40
10-229	KEMP USA THROWABLE FOAM CUSHION RED	41
10-233-ORG	KEMP USA ORANGE 30" RING BUOY USCG APPROVED	39
10-233-WHI	KEMP USA WHITE 30" RING BUOY USCG APPROVED	39
10-234-ROY/WHT-3/8	KEMP USA 3/8" 600' SPOOL ROYAL BLUE/ WHITE POLYPROPYLENE ROPE	59
10-234-ROY/WHT-1/2	KEMP USA 1/2" 600' SPOOL ROYAL BLUE/ WHITE POLYPROPYLENE ROPE	59
10-234-ROY/WHT-3/4	KEMP USA 3/4" 600' SPOOL ROYAL BLUE/ WHITE POLYPROPYLENE ROPE	59
10-234-YEL-3/8	KEMP USA 3/8" 600' SPOOL YELLOW POLYPROPYLENE ROPE	59
10-234-YEL-1/2	KEMP USA 1/2" 600' SPOOL YELLOW POLYPROPYLENE ROPE	59
10-234-YEL-3/4	KEMP USA 3/4" 600' SPOOL YELLOW POLYPROPYLENE ROPE	59
10-235-BWB-5X9	KEMP USA 5X9 EZ-LOCK FLOAT BLUE WHITE BLUE	59
10-235-RWR-5X9	KEMP USA 5X9 EZ-LOCK FLOAT RED WHITE RED	59
10-235-RWB-5X9	KEMP USA 5X9 EZ-LOCK FLOAT RED WHITE BLUE	59
10-297	KEMP USA ORANGE COMPETITION MANIKIN	8
10-298	KEMP USA ORANGE TRAINING MANIKIN	8
10-299	KEMP USA BLACK 10 LB RUBBER DIVING BRICK	48
10-301-BLK	KEMP USA BLACK ONE PIECE SPINE BOARD STRAP	35
10-302-BLK	KEMP USA BLACK TWO PIECE SPINE BOARD STRAP	35
10-304-ROY	KEMP USA ROYAL BLUE TWO PIECE SPINE BOARD STRAP SEAT BELT BUCKLE WITH METAL CLIP ENDS	35
10-305-ORG	KEMP USA ORANGE THREE PIECE VELCRO SPINE BOARD STRAP	35
10-307	KEMP USA REFLECTIVE 10-PT STRAPS WITH CASE	36
10-308	KEMP USA COLOR-CODED 10-PT STRAPS	36
10-401-ORG	KEMP USA ORANGE RESCUE TUBE COVER	39
10-401-RED	KEMP USA RED RESCUE TUBE COVER	39
10-401-ROY	KEMP USA ROYAL RESCUE TUBE COVER	39
10-402-RED	KEMP USA RED SEAL EASY RESCUE TUBE COVER	39
10-421-BLK	FOX40 WHISTLE BLACK	45

# ITEM # INDEX

Item #	Description	Pg #
10-421-GRE	FOX40 WHISTLE GREEN	45
10-421-ORG	FOX40 WHISTLE ORANGE	45
10-421-PIN	FOX40 WHISTLE PINK	45
10-421-PUR	FOX40 WHISTLE PURPLE	45
10-421-RED	FOX40 WHISTLE RED	45
10-421-ROY	FOX40 WHISTLE ROYAL	45
10-421-WHI	FOX40 WHISTLE WHITE	45
10-421-YEL	FOX40 WHISTLE YELLOW	45
10-423-BLK	KEMP USA BLACK PLASTIC PEA WHISTLE	46
10-423-WHI	KEMP USA WHITE PLASTIC PEA WHISTLE	46
10-424	KEMP USA METAL PEA WHISTLE	46
10-425	KEMP USA SPORTS AIRHORN	44
10-426-CUSTOM	KEMP USA CUSTOM PRINTED WHISTLES (call for pricing on larger orders)	NA
10-426-BLK	KEMP USA BLACK BENGAL60 WHISTLE	45
10-426-GRN	KEMP USA GREEN BENGAL60 WHISTLE	45
10-426-ORG	KEMP USA ORANGE BENGAL60 WHISTLE	45
10-426-PNK	KEMP USA PINK BENGAL60 WHISTLE	45
10-426-PUR	KEMP USA PURPLE BENGAL60 WHISTLE	45
10-426-RED	KEMP USA RED BENGAL60 WHISTLE	45
10-426-ROY	KEMP USA ROYAL BLUE BENGAL60 WHISTLE	45
10-426-SIL	KEMP USA SILVER BENGAL60 WHISTLE	45
10-426-YEL	KEMP USA YELLOW BENGAL60 WHISTLE	45
10-429-BLK	KEMP USA BLACK ROPE LANYARD	46
10-429-BLK-ECO	ECONOMY BLACK ROPE LANYARD	46
10-429-RED	KEMP USA RED ROPE LANYARD	46
10-429-RED-ECO	ECONOMY RED ROPE LANYARD	46
10-429-ROY	KEMP USA ROYAL BLUE ROPE LANYARD	46
10-429-ROY-ECO	ECONOMY ROYAL BLUE ROPE LANYARD	46
10-430-BLK	KEMP USA BLACK BREAK-A-WAY LANYARDS	46
10-430-RED	KEMP USA RED BREAK-A-WAY LANYARDS	46
10-430-ROY	KEMP USA ROYAL BLUE BREAK-A-WAY LANYARD	46
10-431	KEMP USA 6 WATT MEGAPHONE	44
10-432	KEMP USA 10 WATT MEGAPHONE	44
10-433	KEMP USA 25 WATT MEGAPHONE	44
10-501	KEMP USA CPR MASK IN HARD CASE WITH GLOVES & WIPES & O2 INLET NO IMPRINT	9
10-501-P (1-color)	KEMP USA CPR MASK IN HARD CASE WITH GLOVES & WIPES & O2 INLET WITH IMPRINT	9
10-501-P (2-color)	KEMP USA CPR MASK IN HARD CASE WITH GLOVES & WIPES & O2 INLET WITH 2 COLOR IMPRINT	9
10-502	AMBU RED CPR MASK IN HARD CASE WITH O2 INLET AND HEAD STRAP WITH GLOVES AND WIPES	9
10-507	AMBU ADULT BAG VALVE MASK - 520211000	7
10-507-HEPA	AMBU ADULT BVM WITH HEPA FILTER	7
10-508	AMBU INFANT BAG VALVE MASK - 540212000	7
10-509	AMBU PEDIATRIC BAG VALVE MASK - 530213000	7
10-509-HEPA	AMBU BVM WITH HEPA FILTER PEDIATRIC	7
10-510	ONE WAY VALVE & FILTER FOR CPR RESUSCITATORS	8
10-514	KEMP USA CPR MASK IN POUCH WITH GLOVES & WIPE	9
10-517	AMBU CPR MASK IN POUCH WITH GLOVES & WIPE	9
10-518	KEMP USA ORANGE CPR BOARD	7
10-519	KEMP USA CPR PROMPT 7PACK MANIKINS	8
10-520	LUNG BAGS ADULT/CHILD 100 PER BOX	8
10-523	AMBU CPR MASK COMO ADULT AND CHILD IN SOFT POUCH	9
10-524	KEMP USA ADULT CPR MASK IN PLASTIC BAG	NA
10-525	KEMP USA WHITE ADULT & CHILD MASK IN HARD CASE WITH GLOVES AND WIPE	9
10-525-P	KEMP USA WHITE ADULT & CHILD CPR MASK IN HARD CASE WITH GLOVES AND WIPE - LOGO 1- color	9
10-526	KEMP USA RED ADULT & CHILD CPR MASK IN POUCH WITH GLOVES AND WIPE	9
10-527	KEMP USA RAPID SEAL RESUSCITATION MASK	7
10-528-ROY	KEMP USA ROYAL BLUE TRAINING VALVE (PACK OF 10)	8
10-530	KEMP USA NAVY BLUE KNEE PAD	25
10-531	PHILLIPS AED	25
10-532	DISPOSABLE CPR SHIELD	NA
10-533	INDIRECT VENT GOGGLES	25
10-534-25	KN95 MASK 25 PACK BOX	25
10-535	BLUE DISPOSABLE FACE MASKS 3-PLY NON-MEDICAL 50 PER BOX	25
10-536	INFRARED NO TOUCH FOREHEAD THERMOMETER	25
10-537	FULL LENGTH CLEAR PLASTIC FACESHIELD 5 PACK	25
10-541	SURGICAL FACE MASKS WITH EAR LOOPS & PLASTIC SHIELD BOX OF 50 PCS	25
10-542	VIROMAX VIRAL & BACTERIAL FILTER	25
10-543	HEPA FILTER FOR BVM OR CPR MASK	25
10-551	VINYL NON-POWDERED GLOVES 50 PAIR PER BOX	25

Item #	Description	Pg #
10-552	NITRILE GLOVES 50 PAIR PER BOX	25
10-596	KEMP USA OB KIT	NA
10-597	KEMP USA BLOODBORNE KIT IN CASE	23
10-599	KEMP USA BLOODBORNE KIT IN BAG	23
10-600	KEMP USA GRAY RELIEF BLANKET	6
10-601	KEMP USA MYLAR FOIL EMERGENCY BLANKET	6
10-602	KEMP USA YELLOW EMERGENCY BLANKET	6
10-604	KEMP USA GRAY 30% WOOL BLANKET	6
10-605	KEMP USA GRAY 50% WOOL BLANKET	6
10-606	KEMP USA GRAY 80% WOOL BLANKET	6
10-608-MAR	KEMP USA FLEECE BLANKET - MAROON*****THIS ITEM IS COMPLETELY BLANK*****	6
10-608-NVY	KEMP USA FLEECE BLANKET - NAVY*****THIS ITEM IS COMPLETELY BLANK*****	6
10-609-130	FLAT SHEET THREAD COUNT 130 (54X90)	54
10-609-180	FLAT SHEET THREAD COUNT 180 (54X90)	54
10-610	3 PC HOSPITAL BED SHEET SET (FLAT SHEET, FITTED SHEET, PILLOW CASE SET) 180 THREAD COUNT (39X80X7)	54
10-612	BLUE & WHITE BEACH TOWEL (36X72)	54
10-613	WHITE GYM TOWEL (20X40)	54
10-614	WHITE BATH TOWEL (22X44)	54
10-699	KEMP USA LIP MOISTURIZER WITH SPF 15 CHERRY FLAVORED	47
10-702	PERSONAL/PROMOTIONAL MINI FIRST AID KIT	24
10-703	KEMP USA 10-UNIT FIRST AID KIT	24
10-705	KEMP USA 24-UNIT FIRST AID KIT	24
10-706	KEMP USA 36-UNIT FIRST AID KIT	24
10-710	NJ FIRST AID KIT LESS THAN 2000 SQ FT	24
10-711	NJ FIRST AID KIT 2000 - 5000 SQ FT	24
10-712	NJ FIRST AID KIT OVER 5000 SQ FT	24
10-713	KEMP USA ILLINOIS STATE FIRST AID KIT	NA
10-714	10 UNIT PLASTIC BOX WITH GASKET EMPTY	24
10-715	24 UNIT PLASTIC BOX WITH GASKET EMPTY	24
10-716	36 UNIT PLASTIC BOX WITH GASKET EMPTY	24
10-717	16 UNIT PLASTIC BOX WITH GASKET EMPTY	24
10-981	KEMP USA WOOD TG SPINEBOARD	30
10-982	KEMP USA AQUATIC EG PLASTIC SPINEBOARD WITH HEAD BLOCKS AND STRAPS	30
10-983	KEMP USA ALUMINUM MILITARY FOLDING COT GREEN	34
10-984	KEMP USA ADULT/CHILD COMBO SPINEBOARD	30
10-986-BLK	KEMP USA BLACK PATIENT CARRY SHEET	34
10-987	KEMP USA EXTRICATION DEVICE	34
10-988-YEL	KEMP USA YELLOW SCOOP STRETCHER	33
10-989	KEMP USA ALUMINUM METAL SCOOP STRETCHER	33
10-990-ORG	KEMP USA ORANGE CHAIR STRETCHER	33
10-991-ORG	KEMP USA ORANGE FOLDING POLE STRETCHER	32
10-992	KEMP USA BLOCKS FOR EG AQUATIC BOARD (PAIR)	29
10-993	KEMP USA SPINEBOARDS PALLET ORDER	31
10-993-ORG	KEMP USA ORANGE ADULT 18" SPINEBOARD	31
10-993-RED	KEMP USA RED ADULT 18" SPINEBOARD	31
10-993-ROY	KEMP USA ROYAL BLUE ADULT 18" SPINEBOARD	31
10-993-WHI	KEMP USA WHITE ADULT 18" SPINEBOARD	31
10-993-YEL	KEMP USA YELLOW ADULT 18" SPINEBOARD	31
10-994	KEMP USA SPINEBOARD MOUNTING BRACKET	36
10-995-ORG	KEMP USA ORANGE FOLDING SPINEBOARD	32
10-996-ORG	KEMP USA ORANGE PEDIATRIC SPINEBOARD	32
10-998-ROY	KEMP USA ROYAL BLUE MCI MASS CASUALTY BOARD - NO FOAM	31
10-998-YEL	KEMP USA YELLOW MCI MASS CASUALTY BOARD - NO FOAM	31
11-001	3/4" X 3" PLASTIC BANDAGES (24 boxes of 100 pcs)	26,27
11-002	1" X 3" PLASTIC BANDAGES (24 boxes of 100 pcs)	26,27
11-003	INSECT BITE SWABS (bulk packaging of 3000 pcs)	26,27
11-005	BZK ANTISEPTIC TOWELETTES (10 boxes of 100 pcs)	26,27
11-007	TRIANGULAR BANDAGE (bulk packaging)	26,27
11-008-2	2X2 GAUZE PADS (24 boxes of 100 pcs)	26,27
11-008-3	3X3 GAUZE PADS (24 boxes of 100 pcs)	26,27
11-008-4	4X4 GAUZE PADS (12 boxes of 100 pcs)	26,27
11-011-2	GAUZE BANDAGES SINGLE ROLL 2" X 5 YDS (8 boxes of 12pcs)	26,27
11-011-3	GAUZE BANDAGES SINGLE ROLL 3" X 5 YDS (8 boxes of 12pcs)	26,27
11-011-4	GAUZE BANDAGES SINGLE ROLL 4" X 5 YDS (8 boxes of 12pcs)	26,27
11-012	WATERPROOF TAPE 1/2" X 2 1/2 YDS (bulk packaging of 500 pcs)	26,27
11-014	BUTTERFLY CLOSURES (24 boxes of 100 pcs)	26,27
11-020	ADHESIVE BANDAGES, PLASTIC 2" X 4.5" X-Large (24 boxes of 50 pcs)	26,27
11-024	1" X 5 YDS WATERPROOF ADHESIVE TAPE IN CASE	26,27
11-025-3.5	3.5" ORANGE BANDAGE SHEARS	26,27

# ITEM # INDEX

Item #	Description	Pg #
11-025-BLK-7.25	7.5" BLACK BANDAGE SHEARS	26,27
11-026	4" STAINLESS STEEL TWEEZERS	26,27
11-028-4OZ	4 OZ LIQUID HAND SANITIZER (4 boxes of 24 pieces)	26,27
11-031	BLUE PE FLUID RESISTANT GOWN (bulk packaging)	26,27
11-032	PLASTIC JUNIOR BANDAGES 3/8" X 1.5" (36 boxes of 100 pieces)	26,27
11-033	FABRIC KNUCKLE BANDAGE 1.5" X 3" (24 boxes of 100 pcs)	26,27
11-045-5X9	COMBINE/ABD PADS STERILE 5 X 9 (20 boxes of 20 pcs)	26,27
11-045-8X10	COMBINE/ABD PADS STERILE 8 X 10 (15 boxes of 24 pcs)	26,27
11-047-2	ELASTIC BANDAGE WITH SELF CLOSURE 2" X 5 YDS (5 boxes of 10 pcs)	26,27
11-047-3	ELASTIC BANDAGE WITH SELF CLOSURE 3" X 5 YDS (5 boxes of 10 pcs)	26,27
11-047-6	ELASTIC BANDAGE WITH SELF CLOSURE 6" X 5 YDS (5 boxes of 10 pcs)	26,27
11-048	STERILE ALCOHOL PREP PADS (10 boxes of 200 pcs)	26,27
11-049	POVIDONE IODINE PREP PAD MEDIUM (10 boxes of 100 pcs)	26,27
11-050	TRIPLE ANTIBIOTIC OINTMENT 0.9G FOIL PACKET (12 boxes of 144 pcs)	26,27
11-051	NON ADHERENT PAD STERILE 2" X 3" (12 boxes of 100 pcs)	26,27
11-052	INSTANT HAND SANITIZER 9 GRAM PACKETS (12 boxes of 144 pcs)	26,27
11-053	AMMONIA INHALANTS .33CC (1 BOX 10 PCS)	26,27
11-151	EMERGENCY BURN GEL 3.5G PACKET (12 boxes of 144 pcs)	26,27
11-153	OVAL EYE PAD (bulk packaging of 1000 pcs)	26,27
11-154	MULTI TRAUMA DRESSING STERILE 10" X 30" (1 box of 50 pcs)	26,27
11-155	SPHYGMOMANOMETER ADULT MEDIUM ARM (1 box of 10 pcs)	26,27
11-156	PETROLEUM GAUZE DRESSING 3" X 9" (4 boxes of 50 pcs)	26,27
11-157-1	POROUS TAPE 1"X 10 YDS (12 boxes of 12 pcs)	26,27
11-157-2	POROUS TAPE 2"X 10 YDS (6 boxes of 12 pcs)	26,27
11-157-3	POROUS TAPE 3"X 10 YDS (4 boxes of 12 pcs)	26,27
11-159-DISP	LED DISPOSABLE PENLIGHT (PUPIL GAUGE) (1 box of 6 pcs)	26,27
11-159-REUSE	LED REUSABLE PENLIGHT (PUPIL GAUGE)	26,27
11-160	DUAL HEAD STETHOSCOPE	26,27
11-161	ORAL AIRWAYS 6 PACK	26,27
11-162	STERILE WATER FOR IRRIGATION 500 ML	26,27
11-163	SALJET TOPICAL STERILE SALINE 1 OZ/30ML	26,27
11-164	LISTER BANDAGE SCISSORS, 7 1/2"	26,27
11-165	KELLY FORCEPS, STRAIGHT, 5 1/2"	26,27
11-166	4" NON STERILE FLUFF GAUZE BANDAGE ROLL	26,27
11-167	BURN SHEET 60" X 90" (bulk packaging of 12 pcs)	26,27
11-168	SELF ADHERENT WRAP 2" X 5 YDS (bulk packaging of 36 pcs)	26,27
11-174	DISPOSABLE APRON (bulk packaging 1000 pcs)	26,27
11-178	COMBAT APPLICATION TOURNIQUET (C_A_T) (sold individually)	26,27
11-179	SHARP BLUNT SCISSORS 5.5"	26,27
11-183-FIN	KEMP USA FINGER SPLINT 10 PCS (sold in packs of 10)	26,27
11-183-ROLL	KEMP USA 36" ROLL SPLINT (sold individually)	26,27
11-612-SML	ICE PACKS SMALL 4" X 6" (1 box of 50 pcs)	26,27
11-612-LRG	ICE PACKS LARGE 5" X 9" (1 box of 24 pcs)	26,27
11-613-SML	HOT PACKS SMALL 4" X 6" (1 box of 50 pcs)	26,27
11-613-LRG	HOT PACKS LARGE 5" X 9" (1 box of 24 pcs)	26,27
11-615	KEMP USA HAND SANITIZER DISPENSER (soap sold separately)	26,27
11-616	KEMP USA HAND SANITIZER FOR DISPENSER	55
12-001-RED/GRD	KEMP USA RED/WHITE GUARD BEACH UMBRELLA	55
12-002-GRN/WHI	KEMP USA GREEN/ WHITE 6' UMBRELLA	44
12-002-NVY/WHI	KEMP USA NAVY/ WHITE 6' UMBRELLA	44
12-002-RED/WHI	KEMP USA RED/ WHITE 6' UMBRELLA	44
12-002-ROY/WHI	KEMP USA ROYAL/ WHITE 6' UMBRELLA	44
12-003-PB	KEMP USA SILVER/ PACIFIC BLUE WIND UMBRELLA	45
12-003-PG	KEMP USA SILVER/ PINE GREEN WIND UMBRELLA	45
12-003-RED-GRD	KEMP USA SILVER/ RED WITH GUARD WIND UMBRELLA	45
12-004-RED	KEMP USA RED 6' GUARD UMBRELLA	44
12-004-ROY	KEMP USA ROYAL BLUE 6' GUARD UMBRELLA	44
12-005	KEMP USA BLACK COMPACT AUTOMATIC OPENING/ SELF COLLAPSING TRAVEL UMBRELLA	53
12-007	KEMP USA UMBRELLA STORAGE BAG	45
14-001-PUR	KEMP USA PURPLE LARGE KICK BOARD	50
14-001-RED	KEMP USA RED LARGE KICK BOARD	50
14-001-ROY	KEMP USA ROYAL BLUE LARGE KICK BOARD	50
14-001-YEL	KEMP USA YELLOW LARGE KICK BOARD	50
14-002	KEMP USA SOLID PULL BUOY	50
14-004-BLK/WHI	KEMP USA BLACK & WHITE BUNGEE CORDS	49
14-004-GRN/WHI	KEMP USA LIME GREEN & WHITE BUNGEE CORDS	49
14-004-PNK/WHI	KEMP USA PINK & WHITE BUNGEE CORDS	49
14-004-RED/BLK	KEMP USA RED & BLACK BUNGEE CORDS	49



Item #	Description	Pg #
14-004-ROY/WHI	KEMP USA ROYAL BLUE & WHITE BUNGEE CORDS	49
14-004-YEL/BLK	KEMP USA YELLOW & BLACK BUNGEE CORDS	49
14-005	KEMP USA ADJUSTABLE PULL BUOY	50
14-006-LRG	KEMP USA WATER AEROBIC BELT LARGE	51
14-006-MED	KEMP USA WATER AEROBIC BELT MEDIUM	51
14-006-SMA	KEMP USA WATER AEROBIC BELT SMALL	51
14-007	KEMP USA BLUE CONTOUR KICKBOARD	50
14-008	KEMP USA AQUATIC DUMBBELLS (PAIR)	51
14-009	KEMP USA AQUATIC BAR FLOAT	51
14-010-LRG	REPLACEMENT WATER BELT STRAP ONLY - SIZE LARGE..	51
14-010-MED	REPLACEMENT WATER BELT STRAP ONLY - SIZE MEDIUM..	51
14-010-SM	REPLACEMENT WATER BELT STRAP ONLY - SIZE SMALL..	51
14-011-RED	KEMP USA RED SMALL KICKBOARD	50
14-011-ROY	KEMP USA ROYAL BLUE SMALL KICKBOARD	50
14-011-YEL	KEMP USA YELLOW SMALL KICKBOARD	50
14-013-MC-XS	KEMP USA MULTI-COLORED PRO WATER AEROBIC BELT SIZE XS COLOR-CODED	51
14-013-PUR-S	KEMP USA PURPLE PRO WATER AEROBIC BELT SIZE SMALL COLOR-CODED	51
14-013-ROY-L	KEMP USA ROYAL BLUE PRO WATER AEROBIC BELT SIZE LARGE COLOR-CODED	51
14-013-YEL-M	KEMP USA YELLOW PRO WATER AEROBIC BELT SIZE MEDIUM COLOR-CODED	51
14-014	KEMP USA PROGRESSIVE 4 PART BACKFLOAT SWIM AID	50
14-015-BLK	BACKSTROKE FLAGS - BLACK	49
14-015-BLU	BACKSTROKE FLAGS - MEDIUM BLUE	49
14-015-GRN	BACKSTROKE FLAGS - KELLY GREEN	49
14-015-MAR	BACKSTROKE FLAGS - MAROON	49
14-015-NVY	BACKSTROKE FLAGS - NAVY	49
14-015-ORG	BACKSTROKE FLAGS - ORANGE	49
14-015-PUR	BACKSTROKE FLAGS - PURPLE	49
14-015-RED	BACKSTROKE FLAGS - RED	49
14-015-ROY	BACKSTROKE FLAGS - ROYAL	49
14-015-WHI	BACKSTROKE FLAGS - WHITE	49
14-015-YEL	BACKSTROKE FLAGS - YELLOW	49
14-016	KEMP USA LEARN 2 SWIM FLOAT BELT FOR CHILDREN	51
14-017	KEMP USA BACKSTROKE FLAG HOOK	49
14-019-RED	KEMP USA POOL NOODLE RED	52
14-019-ROY	KEMP USA POOL NOODLE ROYAL BLUE	52
14-020-RED	KEMP USA POOL SADDLE RED LARGE	52
14-021-RED-SML	KEMP USA POOL SADDLE RED SMALL	52
14-021-ROY-SML	KEMP USA POOL SADDLE ROYAL SMALL	52
17-001-ROY	KEMP USA ROYAL BLUE CLASSIC YOGA MAT	53
17-002	KEMP USA BACK ROLLER ORANGE	53
18-001-1-LRG	KEMP USA WHITE 100% COTTON T-SHIRT- HEART SIZE CHEST & FULL BACK GUARD LOGO SIZE LARGE	47
18-001-1-MED	KEMP USA WHITE 100% COTTON T-SHIRT- HEART SIZE CHEST & FULL BACK GUARD LOGO SIZE MEDIUM	47
18-001-1-SML	KEMP USA WHITE 100% COTTON T-SHIRT- HEART SIZE CHEST & FULL BACK GUARD LOGO SIZE SMALL	47
18-001-1-XL	KEMP USA WHITE 100% COTTON T-SHIRT- HEART SIZE CHEST & FULL BACK GUARD LOGO SIZE XL	47
18-001-1-XXL	KEMP USA WHITE 100% COTTON T-SHIRT- HEART SIZE CHEST & FULL BACK GUARD LOGO SIZE XXL	47
18-001-EMT-2XL	KEMP USA NAVY SIZE 2XL EMT SHIRT PRINTED FRONT AND BACK	53
18-001-EMT-LRG	KEMP USA NAVY SIZE LARGE EMT SHIRT PRINTED FRONT AND BACK	53
18-001-EMT-MED	KEMP USA NAVY SIZE MEDIUM EMT SHIRT PRINTED FRONT AND BACK	53
18-001-EMT-SML	KEMP USA NAVY SIZE SMALL EMT SHIRT PRINTED FRONT AND BACK	53
18-001-EMT-XL	KEMP USA NAVY SIZE XL EMT SHIRT PRINTED FRONT AND BACK	53
18-002-LG	KEMP USA WHITE GUARD TANK TOP-HEARTSIZE CHEST & FULL BACK SIZE LARGE	47
18-002-MED	KEMP USA WHITE GUARD TANK TOP-HEART SIZE CHEST & FULL BACK SIZE MEDIUM	47
18-002-SML	KEMP USA WHITE GUARD TANK TOP-HEART SIZE CHEST & FULL BACK GUARD SIZE SMALL	47
18-002-XL	KEMP USA WHITE GUARD TANK TOP-HEART SIZE CHEST & FULL BACK GUARD SIZE XL	47
18-002-XXL	KEMP USA WHITE GUARD TANK TOP-HEART SIZE CHEST & FULL BACK GUARD SIXE XXL	47
18-003	KEMP USA GUARD SHORTS	NA
18-004-NVY	KEMP USA NAVY LOW PROFILE GUARD CAP WITH EMBROIDERY IN WHITE	48
18-004-RED	KEMP USA RED LOW PROFILE GUARD CAP WITH EMBROIDERY IN WHITE	48
18-004-ROY	KEMP USA ROYAL BLUE LOW PROFILE CAP WITH EMBROIDERY IN WHITE	NA
18-004-WHI	KEMP USA WHITE LOW PROFILE GUARD CAP WITH EMBROIDERY IN RED	48
18-005-NVY	KEMP USA NAVY VISOR WITH EMBROIDERED GUARD LOGO IN WHITE	48
18-005-RED	KEMP USA RED VISOR WITH GUARD LOGO EMBROIDERED IN WHITE	48
18-005-WHI	KEMP USA WHITE VISOR WITH GUARD LOGOEMBROIDERED IN RED	48
18-006-MED	KEMP USA NEON YELLOW 100% COTTON T-SHIRT- HEART SIZE CHEST & FULL BACK GUARD LOGO SIZE MEDIUM	47
18-006-LRG	KEMP USA NEON YELLOW 100% COTTON T-SHIRT- HEART SIZE CHEST & FULL BACK GUARD LOGO SIZE LARGE	47
18-006-SML	KEMP USA NEON YELLOW 100% COTTON T-SHIRT- HEART SIZE CHEST & FULL BACK GUARD LOGO SIZE SMALL	47
18-006-XL	KEMP USA NEON YELLOW 100% COTTON T-SHIRT- HEART SIZE CHEST & FULL BACK GUARD LOGO SIZE XL	47
18-006-XXL	KEMP USA NEON YELLOW100% COTTON T-SHIRT- HEART SIZE CHEST & FULL BACK GUARD LOGO SIZE XXL	47
18-007-RED-LRG	KEMP USA RED SWEAT SHIRT WITH GUARD LOGO IN WHITE LARGE	47

# ITEM # INDEX

Item #	Description	Pg #
18-007-RED-MED	KEMP USA RED SWEAT SHIRT WITH GUARD LOGO IN WHITE MEDIUM	47
18-007-RED-SML	KEMP USA RED SWEAT SHIRT WITH GUARD LOGO IN WHITE SMALL	47
18-007-RED-XL	KEMP USA RED SWEAT SHIRT WITH GUARD LOGO IN WHITE XL	47
18-007-RED-XXL	KEMP USA RED SWEAT SHIRT WITH GUARD LOGO IN WHITE XXL	47
18-008-BLK	KEMP USA SILICONE SWIMMING CAPS BLACK	50
18-008-KGN	KEMP USA SILICONE SWIMMING CAPS KELLY GREEN	50
18-008-NVY	KEMP USA SILICONE SWIMMING CAPS NAVY	50
18-008-ORG	KEMP USA SILICONE SWIMMING CAPS ORANGE	50
18-008-PIN	KEMP USA SILICONE SWIMMING CAPS PINK	50
18-008-PUR	KEMP USA SILICONE SWIMMING CAPS PURPLE	50
18-008-RED	KEMP USA SILICONE SWIMMING CAPS RED	50
18-008-ROY	KEMP USA SILICONE SWIMMING CAPS ROYAL	50
18-008-WHI	KEMP USA SILICONE SWIMMING CAPS WHITE	50
18-008-YEL	KEMP USA SILICONE SWIMMING CAPS YELLOW	50
18-101	KEMP USA ADULT GOGGLES	49
18-102	KEMP USA ADULT GOGGLES	49
18-201-PNK/PUR	KEMP USA CHILDRENS GOGGLES PINK AND PURPLE	49
18-202-BLUE/YEL	KEMP USA CHILDRENS GOGGLES BLUE AND YELLOW	49
19-001	KEMP USA LUXURY POOL LOUNGER	55
19-002	KEMP USA DELUXE POOL FLOAT	52
19-003	KEMP USA OVERSIZED FLOATING WATER PAD	52
20-001-4-PACK	KEMP USA 4 PACK ADULT ORANGE VESTS IN CARRYING CASE	41
20-001-ADULT	KEMP USA ORANGE TYPE II LIFE JACKET ADULT	41
20-001-ADULT-OVR	KEMP USA TYPE II LIFE JACKET ADULT OVERSIZED	41
20-001-CHILD	KEMP USA ORANGE TYPE II LIFE JACKET CHILD	41
20-001-YOUTH	KEMP USA ORANGE TYPE II LIFE JACKET YOUTH	41
20-002-ADULT-RED-OVR	KEMP USA GENERAL PURPOSE VEST ADULT OVERSIZE RED & BLACK	41
20-002-4-PACK	KEMP USA 4 ADULT GENERAL PURPOSE VESTS WITH CARRYING CASE 2/BLUE & 2/RED	41
20-002-ADULT-BLU	KEMP USA BLUE & BLACK GENERAL PURPOSE VEST ADULT	41
20-002-ADULT-RED	KEMP USA GENERAL PURPOSE VEST ADULT RED & BLACK	41
20-002-CHILD-BLU	KEMP USA BLUE & BLACK GENERAL PURPOSE VEST CHILD	41
20-002-CHILD-RED	KEMP USA RED & BLACK GENERAL PURPOSE VEST CHILD	41
20-002-INFANT-BLU	KEMP USA BLUE & BLACK GENERAL PURPOSE VEST INFANT	41
20-002-INFANT-RED	KEMP USA RED & BLACK GENERAL PURPOSE VEST INFANT	41
20-002-YOUTH-BLU	KEMP USA BLUE & BLACK GENERAL PURPOSE VEST YOUTH	41
20-002-YOUTH-RED	KEMP USA RED & BLACK GENERAL PURPOSE VEST YOUTH	41
20-004	KEMP USA COMMERCIAL WORK VEST	41
20-005-BLU-M	KEMP USA USCG BLUE VINYL COATED FOAM SWIM VEST (SIZE M)	55
20-005-BLU-S	KEMP USA USCG BLUE VINYL COATED FOAM SWIM VEST (SIZE S)	55
20-005-BLU-XS	KEMP USA USCG BLUE VINYL COATED FOAM SWIM VEST (SIZE XS)	55
20-005-RED-M	KEMP USA USCG RED VINYL COATED FOAM SWIM VEST (SIZE M)	55
20-005-RED-S	KEMP USA USCG RED VINYL COATED FOAM SWIM VEST (SIZE S)	55
20-005-RED-XS	KEMP USA USCG RED VINYL COATED FOAM SWIM VEST (SIZE XS)	55
20-005-YEL-M	KEMP USA USCG YELLOW VINYL COATED FOAM SWIM VEST (SIZE M)	55
20-005-YEL-S	KEMP USA USCG YELLOW VINYL COATED FOAM SWIM VEST (SIZE S)	55
20-005-YEL-XS	KEMP USA USCG YELLOW VINYL COATED FOAM SWIM VEST (SIZE XS)	55
21-001-10-STL	KEMP USA 10" ALUMINUM BACK POOL BRUSH WITH STEEL BRISTLES	56
21-001-18-NYL	KEMP USA 18" CURVED ALUMINUM BACK POOL BRUSH WITH NYLON BRISTLES	56
21-001-18-NYL-STL	KEMP USA 18" CURVED ALUMINUM BACK POOL BRUSH WITH STAINLESS STEEL & NYLON BRISTLES	56
21-001-STL	KEMP USA 18" ALUMINUM BACK POOL BRUSH WITH STAINLESS STEEL BRISTLES	56
21-002-ECO	KEMP USA ECONOMY POLYPROPYLENE SKIMMER	56
21-002-DXE	KEMP USA HEAVY DUTY SKIMMER WITH ALUMINUM FRAME	56
21-002-DXE-XL	KEMP USA HEAVY DUTY DEEP SKIMMER WITH PLASTIC FRAME	56
21-003-E	KEMP USA ECONOMY LEAF RAKE	57
21-003-HD	KEMP USA HEAVY DUTY LEAF RAKE	57
21-004-CON	KEMP USA CONTOUR WEIGHTED SWIMMING POOL VACUUM HEAD	57
21-004-TRI	KEMP USA TRIANGULAR POOL WEIGHTED POOL VACUUM HEAD	57
21-004-FLX-ECO	KEMP USA FLEXIBLE VACUUM HEAD	57
21-004-FLX-PRO-14	KEMP USA HEAVY DUTY FLEXIBLE VACUUM HEAD	57
21-004-FLX-PRO-19	KEMP USA HEAVY DUTY FLEXIBLE VACUUM HEAD	57
21-005-6-12	KEMP USA 2 WAY TELESCOPING POLE 6' to 12'	58
21-005-5-15	KEMP USA 3 WAY TELESCOPING POLE 5' to 15'	58
21-005-8-16	KEMP USA 2 WAY TELESCOPING POLE 8' to 16'	58
22-001-30	KEMP USA 30' HOSE FOR VACUUM	58
23-001-1	KEMP USA POOL THERMOMETER MODEL 1	58
23-001-2	KEMP USA POOL THERMOMETER MODEL 2	58

# Terms & Conditions



## Ordering

Kemp USA is a manufacturer that only accepts orders from registered distributors who resell. To submit an order or become a registered distributor, please email our account management team at [sales@kempusa.com](mailto:sales@kempusa.com). If we do not confirm your order within 48 hours, please contact us to ensure we received it.

## Shipping

Our corporate office and warehouse is conveniently located in Charlotte, North Carolina. Typical lead time for order fulfillment is 1-2 business days. If a preferred shipping agent is not specified on the order, then we will use FedEx Ground. Unfortunately, FedEx is unable to fulfill orders in which the destination address contains a post office box or a military installation. As always, Kemp USA does not charge a drop ship fee.



## Returns

We understand that our customers have specific needs, and at times, the product just does not work out. Approved returns will be accepted for new, unused, resellable products in the original packaging within 30 days of receipt. Shipping charges will need to be covered at the customer's expense.

## Damages & Claims

We make every effort to properly package all orders. Please note that any damage or shortage of product must be reported to our Customer Service department within 5 business days of receipt of shipment. We may request pictures and/or written documentation of the damaged product for claim purposes. The receiver must hold on to the damaged product for carrier inspection or pick up. If receiving a pallet, it is the receiver's responsibility to make sure the driver is not released until all cartons are counted and examined. Please immediately notify the driver of any damage or missing pieces and make sure you receive a copy of the notation.

## Warranty

Kemp USA warranties all of our products for one (1) year, from the date of receipt, against manufacturer defects. This limited liability warranty will not cover misuse, abuse, neglect, or normal wear and tear.

## Payment Terms & Conditions

All new customers begin on a prepay basis, unless otherwise negotiated. Please remit check payments to:

Kemp USA  
Accounts Receivable  
1900 Bancroft Street  
Charlotte, NC 28206

Kemp USA reserves the right to use a third party collection agency to recover payments on accounts that are 30 days or more overdue. Accounts not paid within terms are subject to a 1% monthly finance charge. All images provided by Kemp USA are for the sole purpose of promoting and selling the Kemp USA brand. Any other use of the images provided by Kemp USA will not be authorized and can result in a permanently deactivated account.

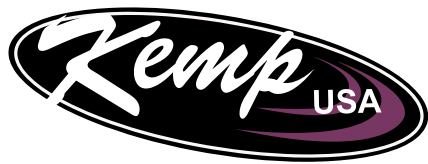

Kemp USA, LLC  
1900 Bancroft St  
Charlotte, NC 28206

P. 855-888-5367  
E. sales@kempusa.com  
www.KempUSA.com

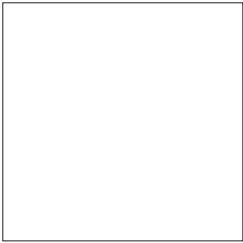

Best stock availability in the industry.



Visit Us At: [www.KempUSA.com](http://www.KempUSA.com)

**WE MAKE  
CUSTOM  
FIRST AID  
KITS!**

*Check out our  
First Aid Kits  
on pg 24.!*



*NEW  
Rapid Seal  
Resuscitation Mask  
See pg. 7*



*Premium Professional Trauma Bag  
with Medical Supply Pack.  
See pg. 12*



*Premium EMS Suitcase  
with Medical Supply Pack.  
See pg. 13*



[www.KempUSA.com](http://www.KempUSA.com) / [sales@KempUSA.com](mailto:sales@KempUSA.com) / 855-888-KEMP (5367)